

Dimensions and installation drawing MR024C axial ring for RLM

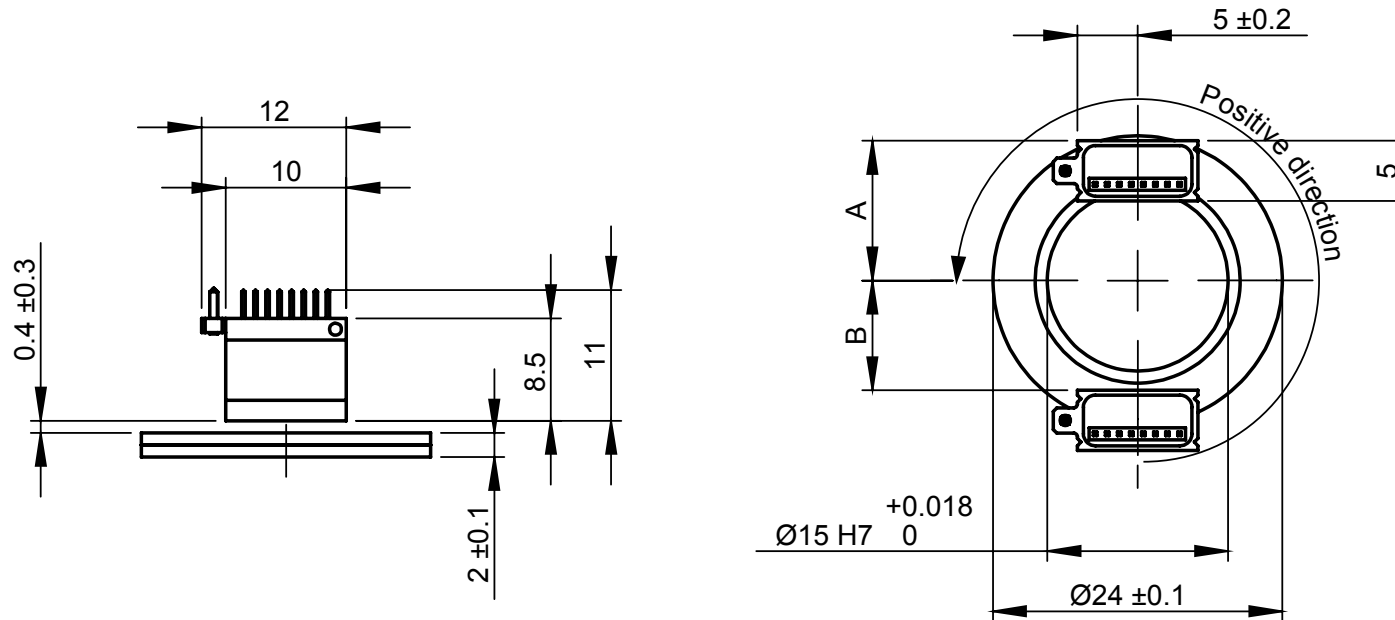

Dimensions and installation tolerance in mm.



Mounting options	CCW (+) ring rotation
A 11.6 ± 0.2 mm	positive counting
B 9.1 ± 0.2 mm	negative counting