

Dimensions and installation drawing MR057R radial ring for RLB

Dimensions and installation tolerance in mm.

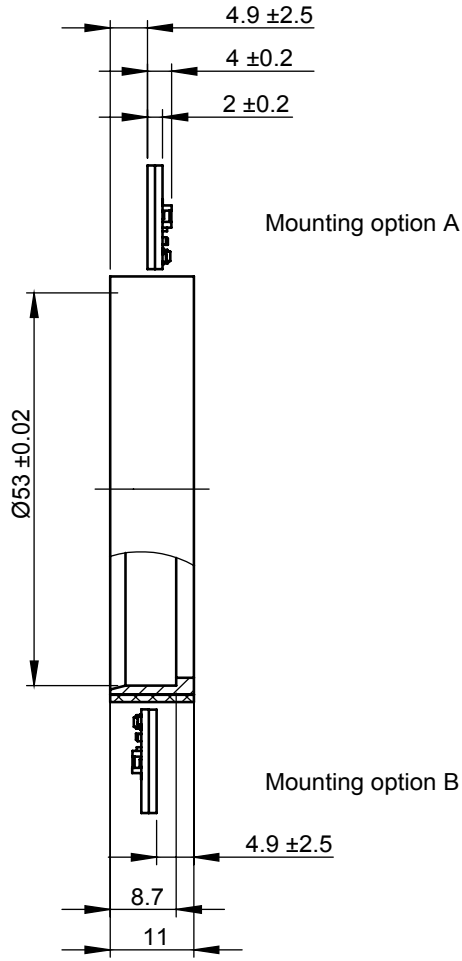
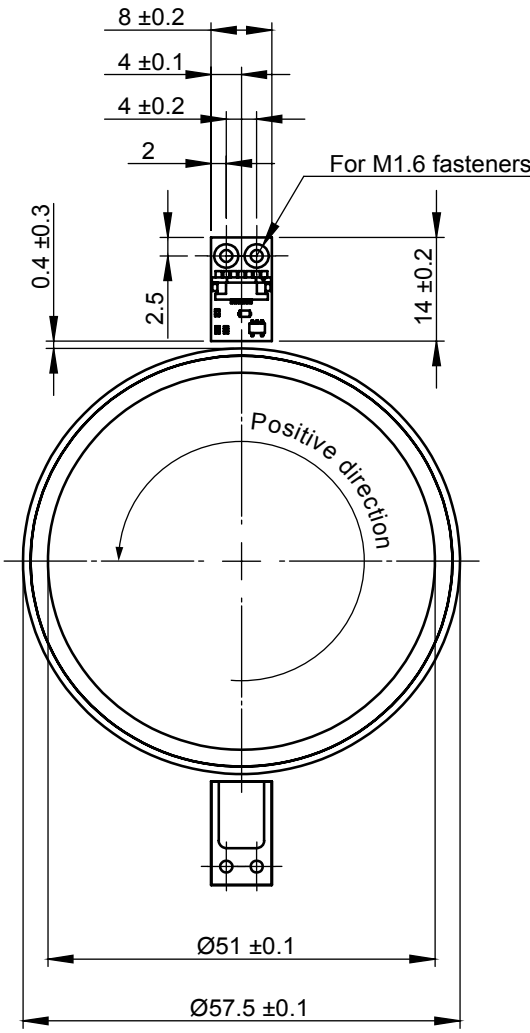

CCW (+) ring rotation	
Mounting A	positive counting
Mounting B	negative counting