

Installation drawing RM36 rotary encoder

Dimensions and tolerances in mm.

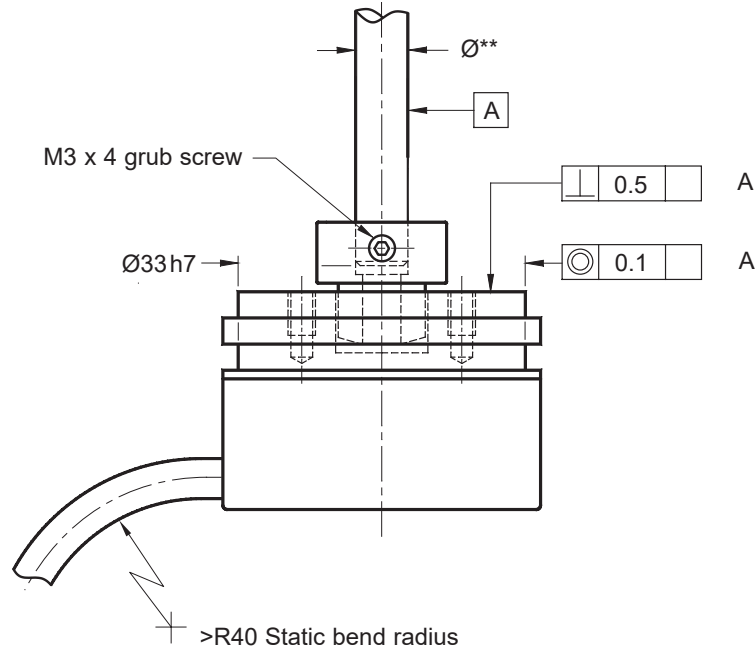

**Nominal shaft size with tolerance h7.

