

Dimensions and installation drawing MR050C axial ring for RLC2HD

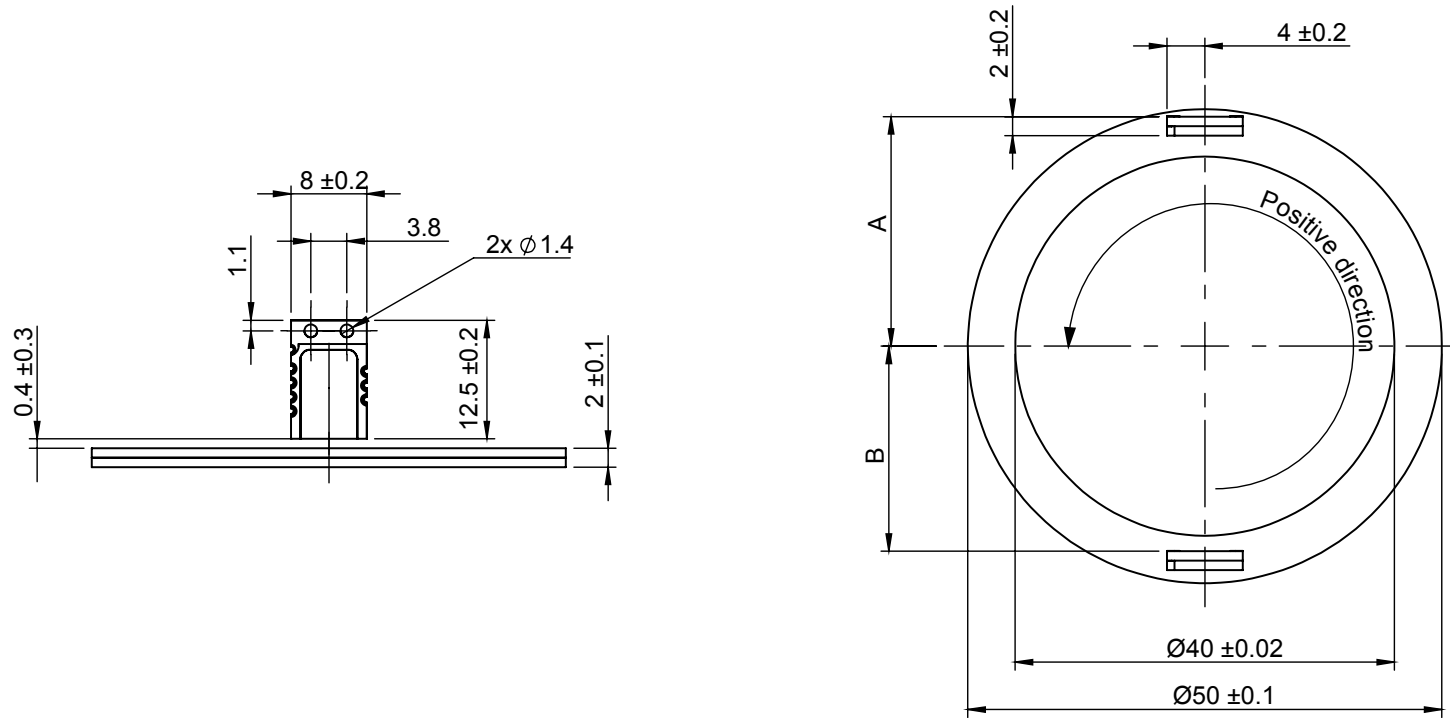

Dimensions and installation tolerance in mm.



Mounting options	CCW (+) ring rotation
A	24.2 ± 0.2 mm positive counting
B	21.6 ± 0.2 mm negative counting