

# Dimensions and installation drawing MR024C axial ring for RLC2HD

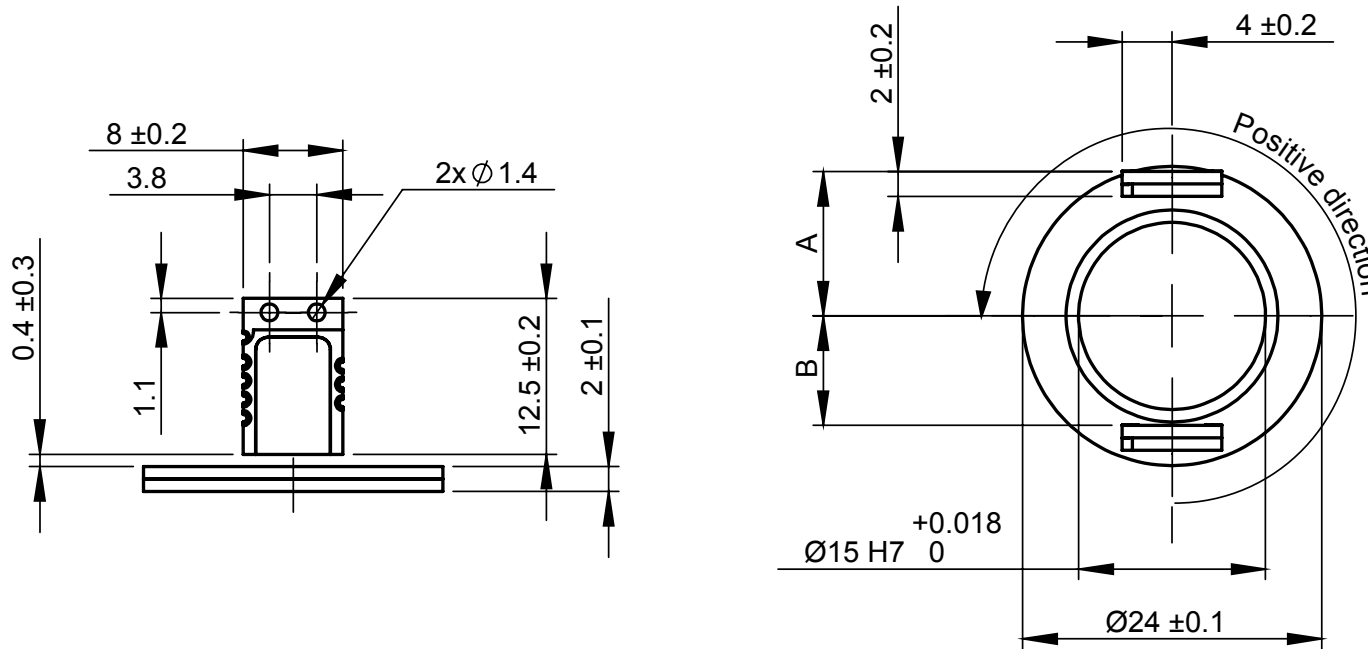

Dimensions and installation tolerance in mm.



Mounting options	CCW (+) ring rotation
A	8.9 ± 0.2 mm positive counting
B	7.7 ± 0.2 mm negative counting