

# Dimensions and installation drawing MR020C axial ring for RLC2HD

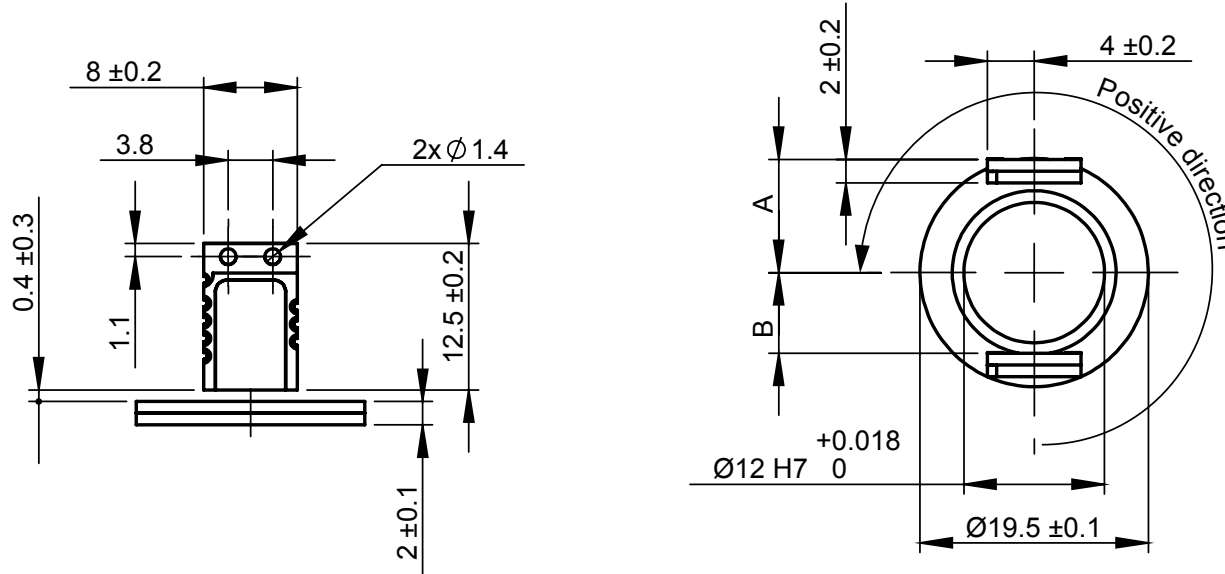

Dimensions and installation tolerance in mm.



Mounting options	CCW (+) ring rotation
<b>A</b>	9.7 ± 0.2 mm positive counting
<b>B</b>	6.9 ± 0.2 mm negative counting