

Dimensions and installation drawing MR020C axial ring for RLB

Dimensions and installation tolerance in mm.

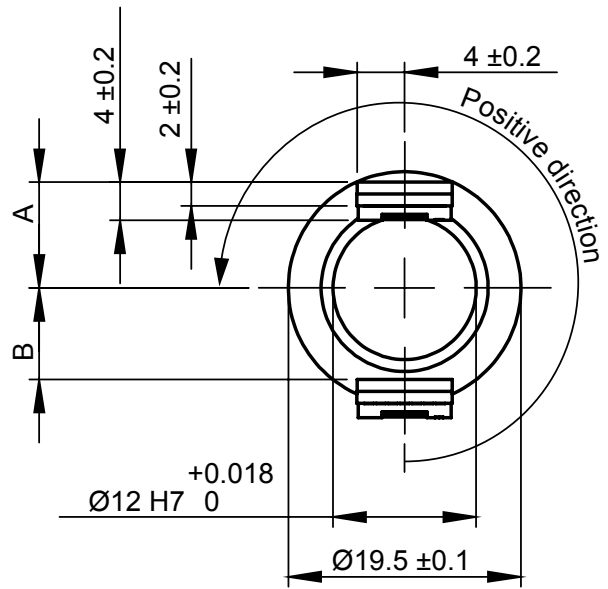
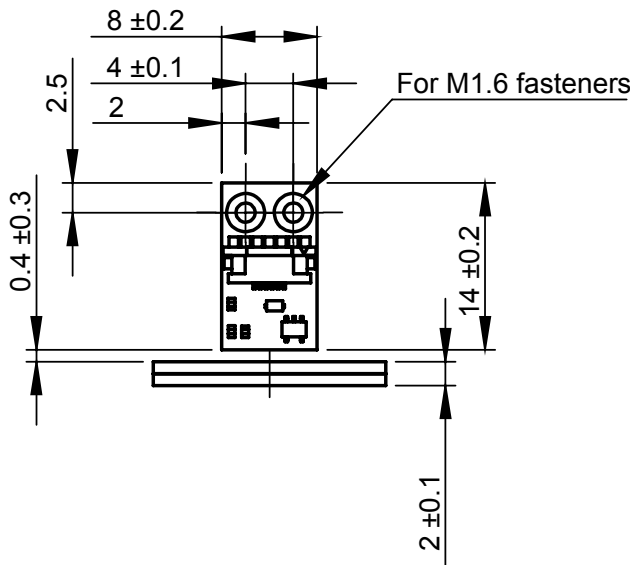

Mounting options	CCW (+) ring rotation	
A	8.9 ± 0.2 mm	positive counting
B	7.7 ± 0.2 mm	negative counting