

AM8192B – angular magnetic sensor chip

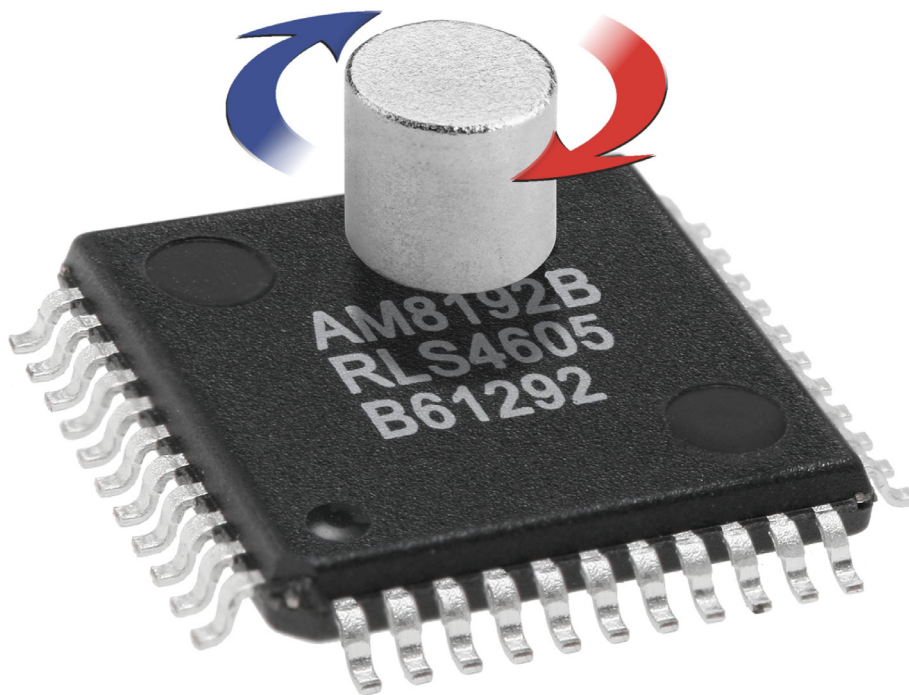

The AM8192B is a compact solution for angular position sensing.

The IC senses the angular position of a permanent magnet placed above or under the chip. The permanent magnet must be diametrically polarized and of cylindrical shape.

The AM8192B uses Hall sensor technology to detect the magnetic flux density distribution at the surface of the silicon. Hall sensors are placed in a circular array around the center of the IC and deliver a voltage representation of the magnetic field distribution.

The sine and cosine voltage outputs from the sensor array vary with magnet position. The analogue signals are then converted to position data using a configurable interpolator. The maximum available resolution is 8192

counts per revolution.

The interpolator inside of the AM8192B chip is configurable using an external EEPROM, while the sensors are already factory optimized for optimum performance. The absolute angle position value can be accessed through the SSI interface. The relative changes of the angle position are output as incremental A QUAD B encoder signals. Both outputs, absolute and incremental are available simultaneously.

With its compact size the AM8192B is especially suitable for different applications, including motor motion control, robotics, camera positioning, various encoder applications and other demanding high resolution applications.

- Contactless angular position encoding over 360°
- 13 bit absolute encoder
- Binary and decimal resolution options
- Incremental and serial SSI output options
- High speed
- 5 V power supply
- SMD package LQFP44

Pin description

Pin	Name	Pin description
1	Prg	OTP setup input
2	Error	Magnetic Error output
3	Cos	Cosine output for monitoring
4	Sin	Sine output for monitoring
5	Ri _{IN}	Input Ri –
6	Sin _{IP}	Input Sine +
7	Sin _{IN}	Input Sine –
8	Cos _{IP}	Input Cosine +
9	Cos _{IN}	Input Cosine –
10	V _{dd}	Power supply +5 V
11	V _{ss}	Power supply 0 V
12	BP	Backplane
13	BP	Backplane
14	V _{dd}	Power supply +5 V
15	V _{ss}	Power supply 0 V
16	Vref	Reference voltage generator
17	BP	Backplane
18	A	Incremental output A
19	B	Incremental output B
20	Ri	Incremental output Ri
21	BP	Backplane
22	BP	Backplane
23	V _{ss}	Power supply 0 V
24	V _{dd}	Power supply +5 V
25	V _{ss}	Power supply 0 V
26	V _{ss}	Power supply 0 V
27	V _{dd}	Power supply +5 V
28	BSI	Factory test
29	Clock	Clock input for SSI
30	V _{ss}	Power supply 0 V
31	V _{ss}	Power supply 0 V
32	V _{ss}	Power supply 0 V
33	V _{dd}	Power supply +5 V
34	Agnd	Sensor reference voltage
35	Agndi	Not used
36	I _{hall}	Input for sensor bias current
37	Data	Data output for SSI
38	EEsda	EEPROM interface, data line
39	EEscl	EEPROM interface, clock line
40	Nerr	Error output, active low
41	Ri _{IP}	Input Ri +
42	I _{boh}	Input for amplifier bias current
43	V _{ss}	Power supply 0 V
44	Prog	OTP setup input

Pin 1 (Prg) is used for OTP (One Time Programming) of the chip. The OTP is carried out at the factory and defines the behavior and accuracy of the AM8192B. In operation pin 1 (Prg) must be left unconnected.

Pin 2 (Error) is an analogue output signal. It can be used for monitoring the alignment between the AM8192B and the magnet. See the “Analogue error signal (Error)” section on page 15 for detailed information.

Pins 3 and 4 are Cosine and Sine output signals for monitoring and filtering. A low-pass filter can be made with an external capacitor as there is a built-in 10 kΩ serial resistor. Recommended value for filtering is a 22 nF capacitor connected to V_{ss}. Capacitor values can be reduced if noise is not an important issue. These outputs can be used for monitoring the signals.

Pin 5 (Ri_{IN}) is the negative analogue input of the built-in interpolator. It enables the reference mark output in incremental mode. It must be connected to Vref (pin 16) to be enabled.

Pin 6 (Sin_{IP}) is the positive analogue input of the built-in interpolator for the sine signal. It must be connected to the Sin signal (pin 4).

Pin 7 (Sin_{IN}) is the negative analogue input of the built-in interpolator for the sine signal. It must be connected to Vref (pin 16).

Pin 8 (Cos_{IP}) is the positive analogue input of the built-in interpolator for the cosine signal. It must be connected to the Cos signal (pin 3).

Pin 9 (Cos_{IN}) is the negative analogue input of the built-in interpolator for the cosine signal. It must be connected to Vref (pin 16).

Pins 10, 14, 24, 27, 33 are power supply pins and must be connected to V_{dd}.

Pins 11, 15, 23, 25, 26, 30, 31, 32, 43 are power supply pins and must be connected to V_{ss}.

Pins 12, 13, 17, 21, 22 are back plane pins and must be connected to V_{ss}.

Pin 16 (Vref) is the interpolator reference voltage generator. The voltage value is 1/2 of V_{dd}.

Pin 18 (A) is the quadrature incremental output A.

Pin 19 (B) is the quadrature incremental output B.

Pin 20 (Ri) is the quadrature incremental reference mark output.

Pin 28 (BSI) is used for factory testing. In operation this pin must be left unconnected

Pin 29 (Clock) is a digital input for serial SSI communication. See the “Binary synchronous serial output SSI” section on page 7 for detailed information.

Pin 34 (Agnd) is a reference voltage for analogue signals and must be connected to Vref (pin 16).

Pin 35 (Agndi) must be left unconnected.

Pin 36 (I_{hall}) is used to define the system sensitivity. When a resistor ($R_{I_{hall}}$) is connected from pin 36 (I_{hall}) to V_{dd} a hall sensor bias current is defined. Recommended value for $R_{I_{hall}}$ is 10 k Ω .

Pin 37 (Data) is a digital output for serial SSI communication. See the “Binary synchronous serial output SSI” section on page 7 for detailed information.

Pin 38 (EEsda) is the data line of the EEPROM interface and must be connected to EEsda (pin 38).

Pin 39 (EEscl) is the clock line of the EEPROM interface and must be connected to EEscl (pin 39).

Pin 40 (Nerr) is a digital error output. If no error is present the output is high.

Pin 41 (R_{iIP}) is the positive analogue input of the built-in interpolator. It enables the reference mark output in incremental mode. It must be connected to V_{dd} to be enabled.

Pin 42 (I_{boh}) is used to define the sensors amplifiers bias current. A resistor ($R_{I_{boh}}$) must be connected between pin 42 (I_{boh}) and V_{ss} . The value for $R_{I_{boh}}$ is 75 k Ω .

Pin 44 (Prog) is used for OTP (One Time Programming) of the chip. The OTP is carried out at the factory and defines the behavior and accuracy of the AM8192B. This pin must be connected to V_{ss} .

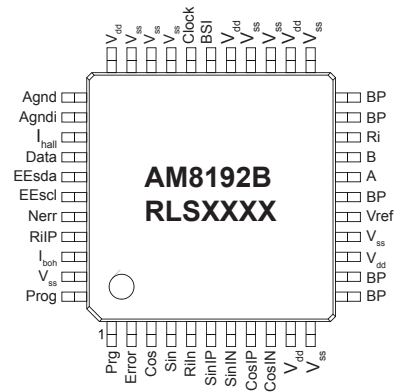

Fig. 1: Pin description for AM8192B

Absolute maximum ratings

$T_A = 22\text{ }^\circ\text{C}$ unless otherwise noted

Parameter	Symbol	Min.	Max.	Unit	Note
Supply voltage	V_{dd}	-0.3	6	V	
Input pin voltage	V_{in}	-0.3	$V_{dd} + 0.3$	V	
Input current (latch-up immunity)	I_{scr}		50	mA	
Electrostatic discharge	ESD		2	kV	*
Operating junction temperature	T_j	-40	150	$^\circ\text{C}$	
Storage temperature range	T_{st}	-40	150	$^\circ\text{C}$	
Moisture sensitivity level			5		

* Human Body Model

Operating range conditions

Parameter	Symbol	Min.	Typ.	Max.	Unit	Note
General						
Operating temperature range	T_o	-40		125	°C	
Supply voltage	V_{dd}	4.75	5	5.25	V	
Supply current	I_{dd}	35	39	43	mA	*
Power-up time	t_p			10	ms	**
Interpolator delay	t_{di}		0.25		µs	
Sensors delay	t_{ds}		2		µs	***
Filtering delay	t_{df}		220		µs	****
Interpolator reference voltage	V_{ref}	48	50	52	% V_{dd}	
Oscillator						
Oscillator frequency	f_{osc}	60	72	83	MHz	*****
Oscillator frequency temperature drift	TC_{osc}		-0.1		% / K	
f_{osc} power supply dependence	VC_{osc}		+10.6		% / V	
Incremental interface, SSI interface outputs						
Saturation voltage hi	V_{shi}	$V_{dd} - 0.4$			V	$I = 4$ mA
Saturation voltage lo	V_{slo}			0.4	V	$I = 4$ mA
Rise time	t_r			60	ns	$C_L = 50$ pF
Fall time	t_f			60	ns	$C_L = 50$ pF
EEPROM interface logic outputs						
Write/read clock at EEscI	f_{scl}		20	100	kHz	
Saturation voltage lo	V_{slo}			0.45	V	$I = 4$ mA
Pull-up current	I_{pu}	75	300	600	µA	
Fall time	t_f			60	ns	$C_L = 50$ pF
SSI, EEPROM interface inputs						
Threshold voltage hi	V_{thi}			2	V	
Threshold voltage lo	V_{tlo}	0.8			V	
Hysteresis	V_{thys}	0.3			V	$V_{thi} - V_{tlo}$
Pull-up current	I_{pu}	-240	-120	-25	µA	
Permissible SSI Clock frequency	CLK_A			4	MHz	

* The supply current changes if external components are changed. Typ. figure is for recommended values, it does not include output drive currents.

** Time between power-on and valid output data.

*** Time delay caused by sensors signal processing. Time delay caused by filtering is not included.

**** Typical time delay is calculated for filter capacitors 22 nF

***** Room temperature, $V_{dd} = 5$ V.

CW rotation and zero position of the magnet

The arrow in Figure 2 shows clockwise (CW) rotation of the magnet. The picture is a top view of the magnet placed above the AM8192B. CCW is counter clockwise rotation. Figure 3 shows a rotational zero position of the magnet regarding to the chip. The picture is a top view of the magnet placed above the AM8192B.

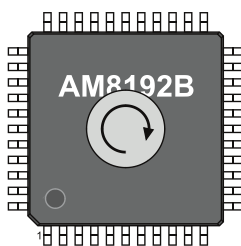

Fig. 2: CW rotation

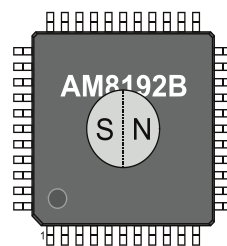

Fig. 3: Zero position

Sinusoidal analogue output for monitoring

Vref is an internally generated reference voltage. It is used as a zero level for the analogue signals. The Vref voltage is 1/2 of V_{dd} . Pins 3 and 4 are unbuffered sinusoidal analogue outputs and they must only be used with a high impedance load. They can be used for filtering and they can be used for monitoring the signals.

Unbuffered sinusoidal outputs:

Parameter	Symbol	Min.	Typ.	Max.	Unit	Note
Internal serial impedance	R_n	8.5	10	11.5	k Ω	
Short circuit current	I_o		100		μ A	*

* When signal level is 1 V and connected to Vref.

Figure 4 shows the timing diagram for CW rotation of the recommended magnet.

Sinusoidal outputs produce one period of sine and cosine signal per turn with phase difference of 90°. Each signal has the same amplitude and minimum offset with respect to Vref.

Sinusoidal output parameters are factory optimized to achieve the best possible accuracy. The optimization is done according to the accuracy of the digital output to eliminate small additional errors from the interpolator. However, the specified accuracy parameters are only valid for magnets specified and used within alignment tolerances. When a load is applied to the analogue outputs, the amplitude is slightly reduced. The load must be connected between signal pins and Vref. The load must be the same for both channels to preserve symmetry.

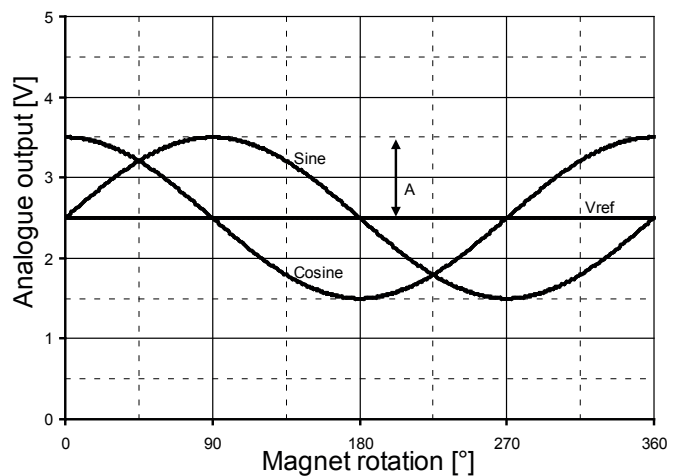

Fig. 4: Timing diagram for analogue output

The AM8192B signal amplitude can vary from chip to chip within the same batch and at equal conditions with a standard deviation of 20 mV.

Sinusoidal signal parameters:

Parameter	Symbol	Min.	Typ.	Max.	Unit	Note
Amplitude	A	0.5	1.04	1.4	V	*
Vref voltage	V_{Vref}		$V_{dd}/2$		V	
Maximum frequency	f_{Max}		1000		Hz	**

* Amplitude = 1/2 of peak to peak value. The power supply voltage, the distance to the magnet and temperature are within tolerances. The amplitude must never exceed 1.5 V to prevent saturation of the signals.

** Rotation of the magnet defines the frequency. The maximum frequency depends on filtering and interpolator settings.

Interpolator

The fast converter changes sine and cosine signals into angle position data. The resolution, hysteresis and output direction are selectable. It calculates an arctangent function from a ratio between the sine and cosine signal. The amplitude of the sine and cosine signal therefore is not important as long they are the same. Angle position data is output as an absolute value via the SSI interface and in incremental A QUAD B signals simultaneously.

Available binary resolutions:

Binary res.	Res. in degrees	Maximum input freq. *	Minimal t_{TD} **
8192	0.0439°	0.63 kHz	122 ns
4096	0.0879°	1 kHz	146 ns
2048	0.1758°	1 kHz	293 ns
1024	0.3516°	1 kHz	585 ns
512	0.7031°	1 kHz	1.17 μ s
256	1.4062°	1 kHz	2.34 μ s
128	2.8125°	1 kHz	4.68 μ s
64	5.625°	1 kHz	9.36 μ s
32	11.25°	1 kHz	18.8 μ s

Available decimal resolutions:

Dec. res.	Res. in degrees	Maximum input freq. *	Minimal t_{TD} **
2000	0.18°	1 kHz	293 ns
1600	0.225°	1 kHz	390 ns
1000	0.36°	1 kHz	585 ns
800	0.45°	1 kHz	780 ns
500	0.72°	1 kHz	1.26 μ s
400	0.9°	1 kHz	1.56 μ s
320	1.125°	1 kHz	1.95 μ s
200	1.8°	1 kHz	3.12 μ s
160	2.25°	1 kHz	3.90 μ s
100	3.6°	1 kHz	6.24 μ s
80	4.5°	1 kHz	7.80 μ s
40	9°	1 kHz	15.6 μ s

* Charts are for worst case (high temperature, low power supply voltage) values of oscillator frequency (f_{osc}).

** See Figure 5. Charts are for highest values of oscillator frequency ($f_{osc} = 83$ MHz).

Incremental output

There are three signals for incremental output: A, B and Ri. Signals A and B are quadrature signals, shifted by 90°, and signal Ri is a reference mark. The reference mark signal is produced once per revolution. The width of the Ri pulse is 1/4 of the quadrature signal period and it is synchronized with the A and B signals. The reference mark is positioned at 0° (where the sine signal amplitude is 0 and the cosine signal amplitude is at its maximum value).

Figure 5 shows the timing diagram of A, B and Ri signals with CW rotation of the magnet and positive counting direction. B leads A for CW rotation. The counting direction can be changed by swapping the A and B signals or by programming the EEPROM with negative counting direction settings.

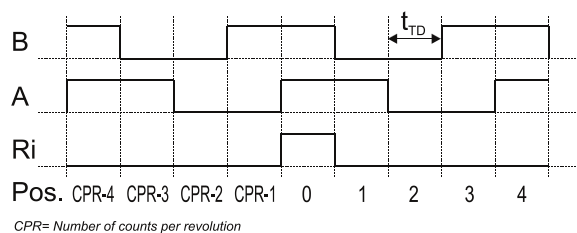

Fig. 5: Timing diagram for incremental output

The transition distance (t_{TD}) is the time between two output position changes. The transition distance time is limited by the interpolator and the limitation is dependent on the output resolution. The counter must be able to detect the minimum transition distance to avoid missing pulses.

Binary synchronous serial output SSI

Serial output data is available in up to 13 bit natural binary code through the SSI protocol. If the counting direction is set to positive, the value of the output data increases when the magnet is rotated CW. When the counting direction is set to negative and the magnet is rotated CW, the value of the output data decreases.

Parameter	Symbol	Min.	Max.	Unit	Note
Clock period	t_{CL}	250	$2 \times t_m$	ns	
Clock high	t_{CHI}	25	t_m	ns	
Clock low	t_{CLO}	25	t_m	ns	
Monoflop time	t_m	12.5	20.5	μs	*

* Depends on master clock frequency ($t_m = 1024 / f_{osc}$)

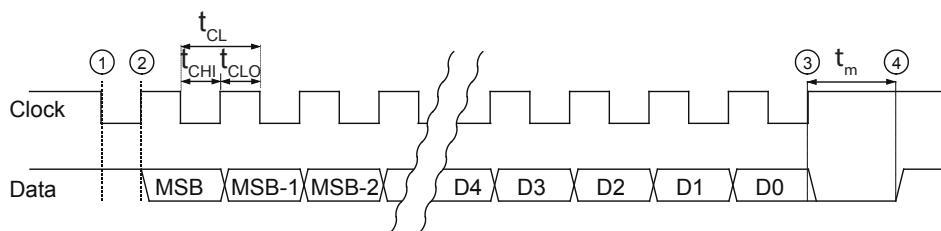

Fig. 6: SSI timing diagram

The controller interrogates the AM8192B for its positional value by sending a pulse train to the Clock input. The Clock signal must always start from high. The first high/low transition (point 1) stores the current position data in a parallel/serial converter and the monoflop is triggered. With each transition of Clock signal (high/low or low/high) the monoflop is retriggered. At the first low/high transition (point 2) the most significant bit (MSB) of binary code is transmitted through the Data pin to the controller. At each subsequent low/high transition of Clock the next bit is transmitted to the controller. While reading the data the t_{CHI} and t_{CLO} must be less than t_{mMin} to keep the monoflop set. After the least significant bit (LSB) is output (point 3) the Data goes to low. The controller must wait longer than t_{mMax} before it can read updated position data. At this point the monoflop time expires and the Data output goes to high (point 4).

It is possible to read the same position data several times to enlarge the reliability of transmitted data if the ring register SSI mode is selected (SSI multi-read of the same position data, ring register mode). The controller must continue sending the Clock pulses and the same data will be output again. Between the two outputs one logic zero will be output.

When no ring register mode is selected, the data is output only once (SSI no ring register mode).

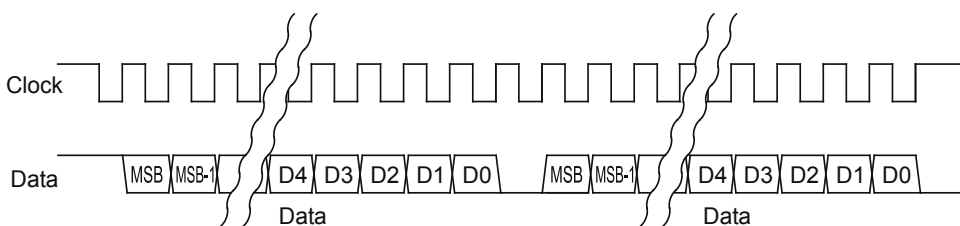

Fig. 7: SSI multi-read of the same position data, ring register mode

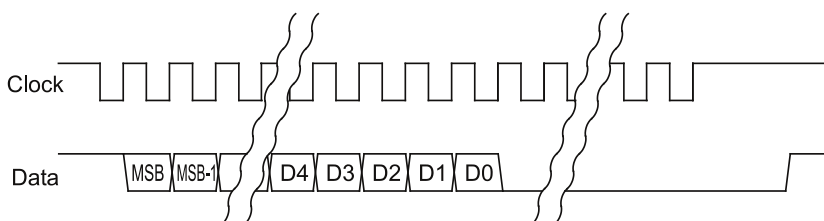

Fig. 8: SSI no ring register mode

Hysteresis

The AM8192B uses an electrical hysteresis when converting analogue signals to digital. The hysteresis must always be larger than the peak noise to assure a stable digital output. The effect is a position hysteresis when rotating the magnet CW or CCW. Hysteresis is one of the configurable parameters of the interpolator.

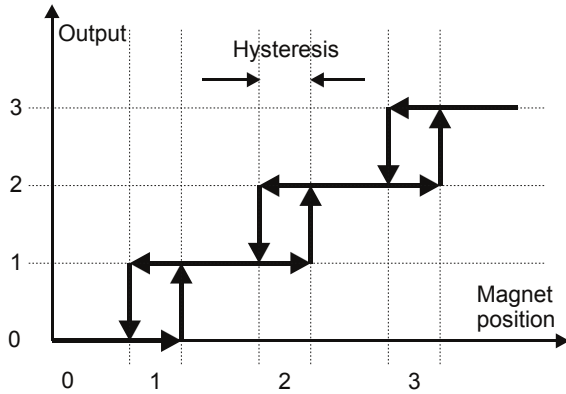

Fig. 9: Hysteresis

Available typical hysteresis:

Hysteresis	Unit	Note
0	deg	
0.088	deg	= 360°/4096
0.176	deg	= 360°/2048 *
0.352	deg	= 360°/1024
0.703	deg	= 360°/512
1.406	deg	= 360°/256

* Recommended value

Variation of hysteresis when the recommended value is set:

Parameter	Symbol	Min.	Typ.	Max.	Unit	Note
Hysteresis	Hyst	0.06	0.17	0.25	deg	*
Hysteresis standard deviation	Hyst _{STDEV}		0.035		deg	**

* Measured at slow movement to avoid delay caused by filtering.

** Standard deviation of the hysteresis measured on 3000 samples.

Noise and filtering

The AM8192B uses Hall sensors for detecting the magnetic flux distribution. Noise on the Hall sensors is seen as noise on the output position. The noise can be represented as a standard deviation or peak value. The peak value is 5 times larger than the standard deviation.

For reducing the noise an RC filter is used on the sine and cosine signals. 10 kΩ resistors and 120 pF capacitors are inside the chip and external capacitors can be added. The recommended value for external capacitors is 22 nF, but this can be changed if needed. Using an RC filter introduces an output position delay when rotating at high speeds.

Position delay can be calculated as follows:

$$\Delta\phi = \text{Arc tan}\{f / f_0\} \quad (f = \text{frequency}, f_0 = (2\pi RC)^{-1})$$

At high rotational speed the analogue amplitude decreases. Normally, this amplitude drop is negligible. It must only be considered in the combination of large frequency and large capacitors. The amplitude should not drop below 0.5 V.

$$\Delta A = 1 - \frac{1}{\sqrt{1 + (f/f_0)^2}}$$

The hysteresis used must always be larger than the peak noise. If peak noise is larger than hysteresis, the output direction could change even when magnet rotation direction is not. The interpolator always assures that the incremental output will not have missing pulses. If the peak noise is larger than resolution, intermediate pulses are generated. The intermediate pulses will be generated with minimal time distance t_{TD} . Minimal time distance of generated pulses t_{TD} is defined by the resolution setting of AM8192B (see the available resolutions table in the "Interpolator" section on page 6).

Calculating the amount of noise:

The following graphs show the multiplication factors for peak noise against changing parameters. To calculate the total amount of peak noise, multiply all factors by the nominal peak noise. The peak noise at nominal conditions is 0.041°.

Default parameters:

- 22 nF filtering capacitors
- Room temperature (22 °C)
- 5 V power supply
- 1.9 mm distance between top of the magnet and surface of the chip
- Ø4 × 4 mm diametrically polarized SmCo17 magnet

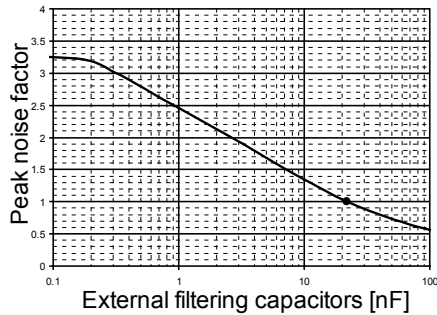

Fig. 10: Peak noise factor Vs Filtering

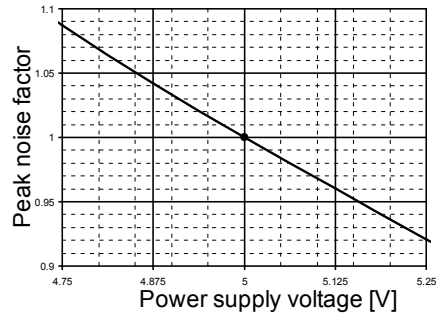

Fig. 11: Peak noise factor Vs Power supply

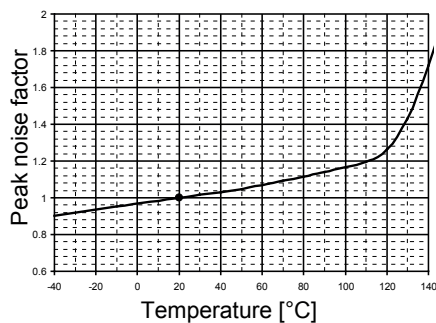

Fig. 12: Peak noise factor Vs Temperature (temperature coefficient of the magnet is included)

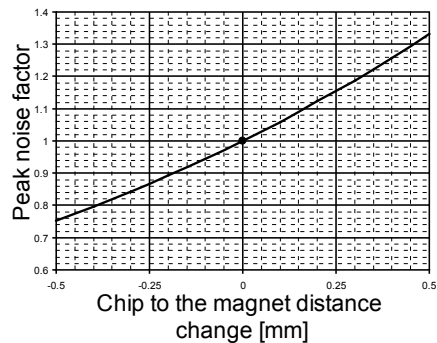

Fig. 13: Peak noise factor Vs Distance change

Example calculation for a system operating at 80 °C, 10 nF filtering, 4.9 V power supply and 0.1 mm increased distance would give us (reading from the graphs above):

Peak noise factor at 10 nF filtering = 1.35

Peak noise factor at 4.9 V power supply = 1.03

Peak noise factor at temperature 80 °C = 1.11

Peak noise factor at 0.1 mm increased distance = 1.06

Total peak noise = $0.041^\circ \times 1.35 \times 1.03 \times 1.11 \times 1.06 = 0.067^\circ$

Signal amplitude at different frequencies and different filtering capacitors [mV]:

		External filtering capacitors							
		0.5 nF	1 nF	2.2 nF	4.7 nF	10 nF	22 nF	47 nF	100 nF
Frequency	0 Hz	1040.0	1040.0	1040.0	1040.0	1040.0	1040.0	1040.0	1040.0
	1 Hz	1040.0	1040.0	1040.0	1040.0	1040.0	1040.0	1040.0	1040.0
	2 Hz	1040.0	1040.0	1040.0	1040.0	1040.0	1040.0	1040.0	1039.9
	5 Hz	1040.0	1040.0	1040.0	1040.0	1040.0	1040.0	1039.9	1039.5
	10 Hz	1040.0	1040.0	1040.0	1040.0	1040.0	1039.9	1039.5	1037.9
	20 Hz	1040.0	1040.0	1040.0	1040.0	1039.9	1039.6	1038.2	1031.9
	50 Hz	1040.0	1040.0	1040.0	1039.9	1039.5	1037.5	1028.8	992.1
	100 Hz	1040.0	1040.0	1039.9	1039.5	1037.9	1030.1	997.2	880.3
	200 Hz	1040.0	1039.9	1039.6	1038.1	1031.7	1002.0	894.9	647.1 *
	500 Hz	1039.8	1039.4	1037.2	1028.3	991.1	854.0	582.2 *	315.1 *
1000 Hz	1039.2	1037.4	1029.1	995.4	877.6	607.4 *	332.8 *	163.3 *	

* Amplitude must remain above 800 mV, otherwise lower frequencies or filtering must be used.

Phase delay at different frequencies and different filtering capacitors [°]:

		External filtering capacitors							
		0.5 nF	1 nF	2.2 nF	4.7 nF	10 nF	22 nF	47 nF	100 nF
Frequency	0 Hz	0.0000	0.0000	0.0000	0.0000	0.0000	0.0000	0.0000	0.0000
	1 Hz	0.0022	0.0040	0.0084	0.0174	0.0364	0.0796	0.1696	0.3604
	2 Hz	0.0045	0.0081	0.0167	0.0347	0.0729	0.1593	0.3393	0.7208
	5 Hz	0.0112	0.0202	0.0418	0.0868	0.1822	0.3982	0.8481	1.8016
	10 Hz	0.0223	0.0403	0.0835	0.1735	0.3643	0.7963	1.6958	3.5996
	20 Hz	0.0446	0.0806	0.1670	0.3470	0.7286	1.5922	3.3887	7.1710
	50 Hz	0.1116	0.2016	0.4176	0.8675	1.8210	3.9752	8.4204	17.4603
	100 Hz	0.2232	0.4032	0.8351	1.7347	3.6383	7.9125	16.4921	32.1729
	200 Hz	0.4464	0.8063	1.6699	3.4662	7.2475	15.5342	30.6309	51.5216
	500 Hz	1.1159	2.0152	4.1686	8.6106	17.6370	34.7962	55.9598	72.3631
1000 Hz	2.2309	4.0254	8.2936	16.8489	32.4506	54.2647	71.3368	80.9676	

There is a tradeoff between resolution, speed, filtering, temperature range, time delay and hysteresis. Carefully choose proper settings to optimize the performance of your encoder.

Nonlinearity

Nonlinearity is defined as the difference between the actual angular position of the magnet and the angular position output from the AM8192B. There are different types of nonlinearity.

Differential nonlinearity is the difference between the measured position step and the ideal position step. The position step is the output position difference between any two neighboring output positions, while the ideal position step is 360° divided by the resolution. Differential nonlinearity is mainly caused by noise. An additional 0.02° of differential nonlinearity is caused by the interpolator. Differential nonlinearity is always less than one position step because there is a system that prevents missing codes. Figure 14 shows a typical differential nonlinearity plot of the AM8192B with 12 bit resolution, 22 nF filtering and default parameters.

Integral nonlinearity is the total position error of the AM8192B output. Integral nonlinearity includes all position errors but does not include the quantization error. Integral nonlinearity is minimized during production to better than $\pm 0.2^\circ$. Figure 15 shows a typical integral nonlinearity plot of the AM8192B with 12 bit resolution, a perfectly aligned magnet, 22 nF filtering and default parameters. Integral nonlinearity can increase if the default parameters are changed. The effects of different parameters to integral nonlinearity are described separately.

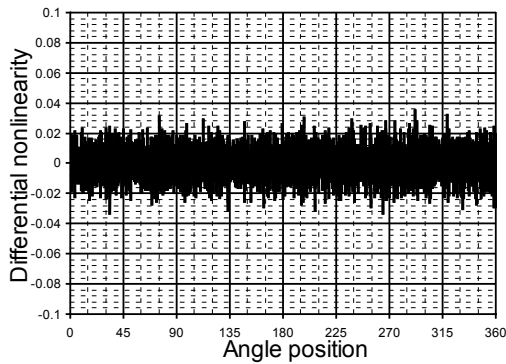

Fig. 14: Typical differential nonlinearity

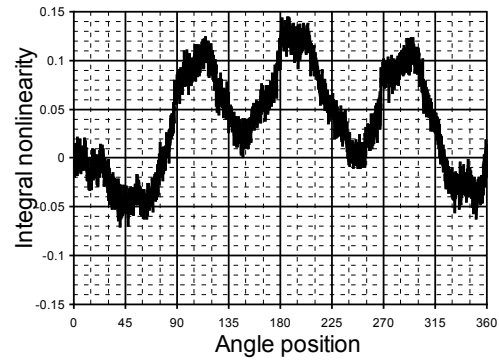

Fig. 15: Typical integral nonlinearity

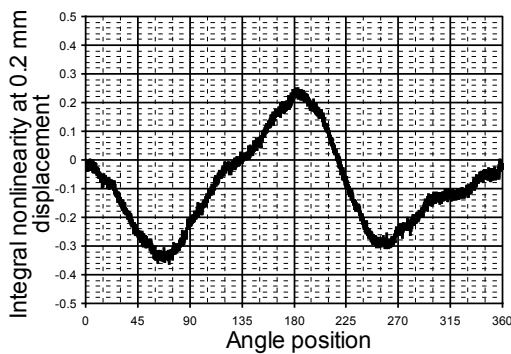

Fig. 16: Typical integral nonlinearity when the chip is displaced for 0.2 mm

Recommended magnet

The AM8192B can be supplied with a pre-selected magnet to ensure that optimum performance is achieved. Alternatively, magnets can be sourced from other suppliers but they must conform to the following guidelines.

To select a suitable magnet it is important to know the properties of the sensors. Hall Sensors are only sensitive to the perpendicular component of the magnetic flux density (B). The AM8192B has a Hall sensor array arranged in a circle with a radius of 2.4 mm. The sensors are located on the surface of the silicon. The nominal distance between the sensors and the magnet surface is 2.55 mm.

Magnets must be cylindrical in shape and diametrically polarized. The main criterion for magnet selection is the modulation of the perpendicular component of magnetic flux density at the location of the sensors (B_n) and a low offset of magnet modulation.

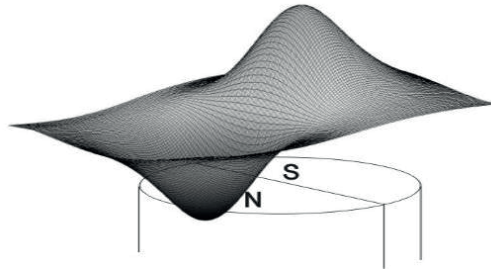

Fig. 17: Distribution of the perpendicular component of B

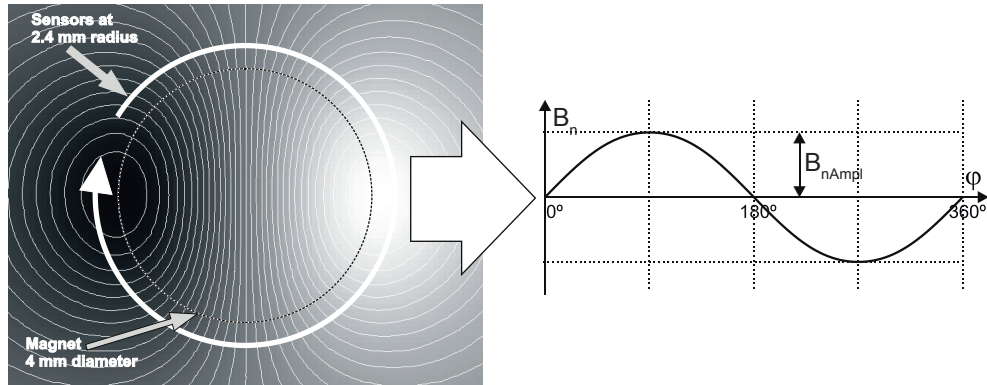

Fig. 18: Distribution of B_n and its modulation if the magnet is rotated through 360°

Parameter	Symbol	Min.	Typ.	Max.	Unit	Note
Amplitude of B_n modulation	B_{nAmpl}		40		mT	*
Offset of B_n modulation	$B_{nOffset}$	-0.4		0.4	mT	**

* Typical value of B_{nAmpl} will give an analogue signal output with amplitude of 1 V. The amplitude of the signal is proportional to the B_{nAmpl} . 1 Tesla equals 10,000 Gauss.

** Bad quality magnets offset the B_n modulation which results in increased integral nonlinearity when the magnet is not aligned correctly with respect to the chip.

We recommend that a magnet with the following parameters is used to provide the necessary modulation:

Parameter	Typ.	Unit	Note
Diameter	4	mm	
Length	4	mm	
Material	Sm2Co17		*
Material remanence	1.05	T	
Temperature coefficient	-0.03	% / °C	
Curie temperature	720	°C	

* Rare earth material magnets SmCo are recommended; however, NdFeB magnets can be used but they have different characteristics.

Magnet quality and the nonlinearity error

Each AM8192B is optimized during the production to give best performance with an ideal magnet when perfectly aligned. An ideal magnet would have the polarization border exactly in the middle of the magnet. If the polarization is not exactly in the middle of the magnet then the modulation of the magnetic field has an offset.

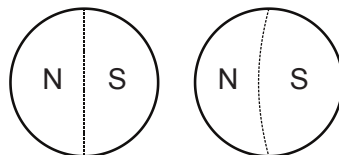

Fig. 19: Ideally polarized magnet and not ideally polarized magnet

The offset represents a mean value of B_n when the magnet is rotated through 360° and B_n is measured at 2.55 mm distance from the magnet surface and at 2.4 mm radius.

Offset will cause larger than normal integral nonlinearity errors if the AM8192B placement is not in the center of the magnet rotation. Figure 20 shows an additional integral nonlinearity error caused by misalignment of the AM8192B for ideal and recommended magnets. Total integral nonlinearity is the summation of integral nonlinearity and the additional integral nonlinearity error caused by magnet displacement.

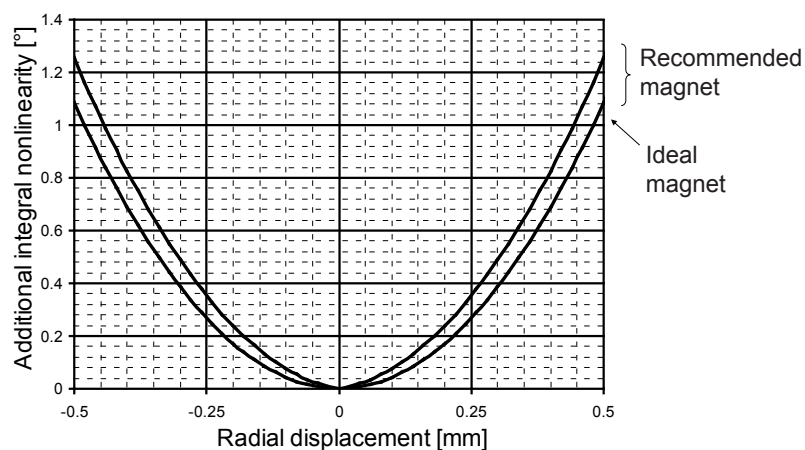

Fig. 20: Additional integral nonlinearity error caused by magnet displacement

It is important that magnetic materials are not close to the magnet because they can increase the integral nonlinearity. They should ideally be at least 3 centimeters away from the chip. The magnet should be mounted in a non-magnetic carrier.

Magnet position

The magnet can be placed below or above the device. The typical distance between the magnet and the sensors must be 2.55 mm for the recommended magnet.

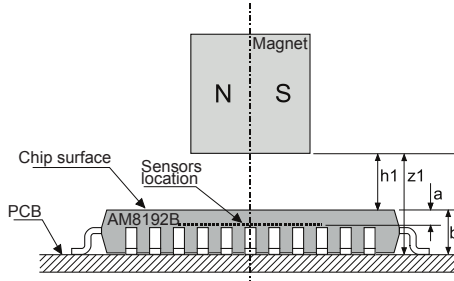

Fig. 21: Magnet placed above the AM8192B

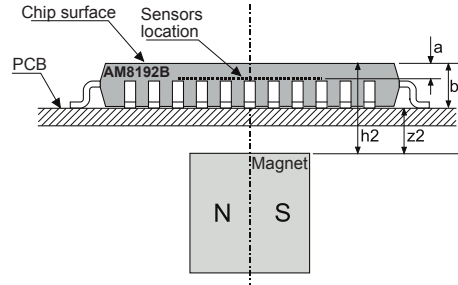

Fig. 22: Magnet placed below the AM8192B

Parameter	Symbol	Min.	Typ.	Max.	Unit	Note
Distance sensors - chip surface	a		0.65		mm	
Distance PCB plane - chip surface	b		1.58		mm	*
Distance chip surface - magnet	h1	1.70	1.90	2.10	mm	
Distance PCB plane - magnet	z1	3.28	3.48	3.68	mm	*
Distance chip surface - magnet	h2	3.00	3.20	3.40	mm	*
Distance PCB plane - magnet	z2	1.42	1.62	1.82	mm	*

* For typical 40 μm copper thickness of PCB

Magnet position

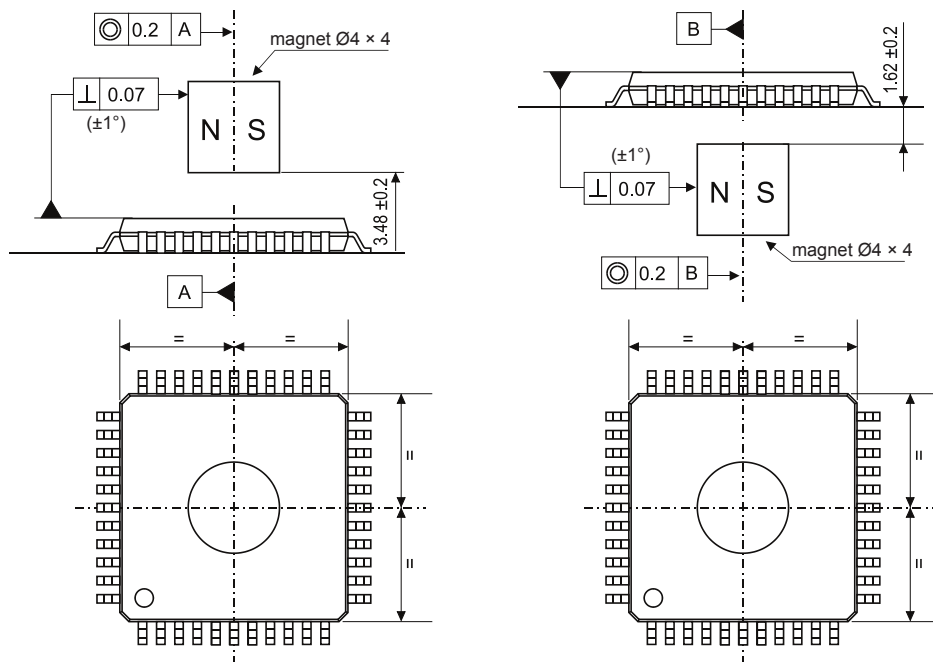

Fig. 23: Mounting instructions

Analogue error signal (Error)

The error signal output (pin 2) is a magnetic error output and it can be used for alignment of the AM8192B. The chip must be perfectly perpendicular to the axis of the magnet rotation so as to be able to use the error signal for alignment. The error signal is sinusoidal in shape with one period per turn. The amplitude of the error signal is proportional to the AM8192B displacement (figure 26). The phase of the sinusoidal error signal Error signal shape is proportional to the displacement angle. To achieve optimum setup the amplitude of the error signal should be minimized.

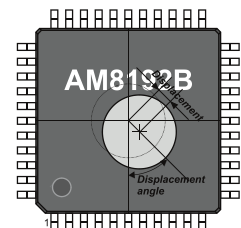

Fig. 24: Magnet displacement. Magnet is placed above the AM8192B.

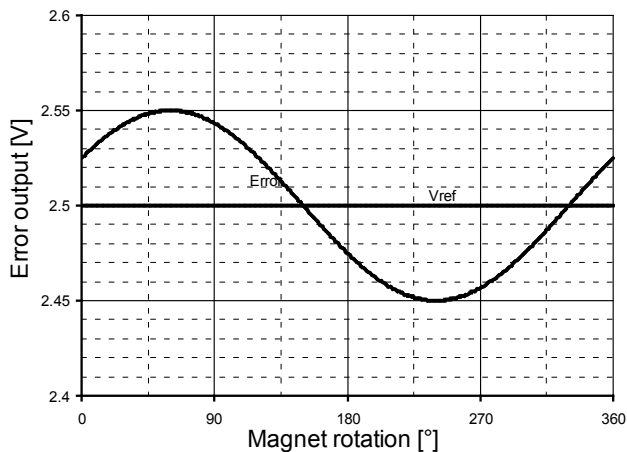

Fig. 25: Error signal shape

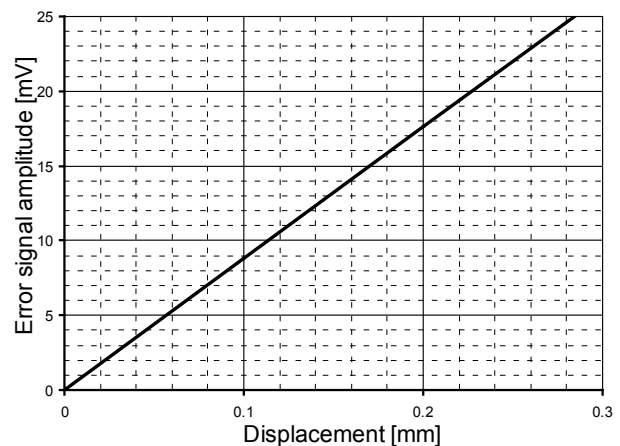

Fig. 26: Error signal amplitude

Digital error output (Nerr)

The digital error output can be used to check if the frequency is too high and if the magnetic signal is too low. When no error is present the output is high. When an error is present the output is PWM modulated according to the failure mode with a frequency of 16 Hz. If data transfer from the EEPROM at startup is faulty and unsuccessful, then the error output is constantly low. For monitoring it is possible to connect an LED with a 1 k Ω serial resistor between Nerr and V_{dd}.

Failure mode	Nerr output	Note
No error	Hi	
Amplitude error	Lo/Hi = 75%	If amplitude is lower than $0.1 \times V_{dd}$ *
Frequency error	Lo/Hi = 50%	If frequency is higher than maximum frequency **
Configuration	Lo	

* The amplitude error can not detect if the magnet is too close.

** The maximum frequency depends on the resolution (see the "Interpolator" section on page 5). For resolutions below 4096 the maximum frequency is 1 kHz.

Characteristics

Typical behavior of the AM8192B under different parameter changes:

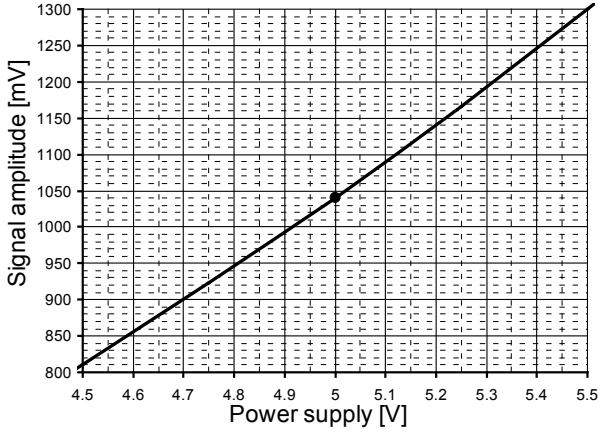

Fig. 27: Signal amplitude Vs Power supply

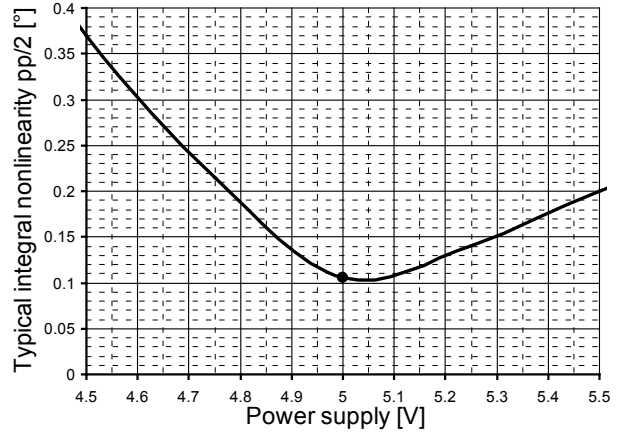

Fig. 28: Accuracy Vs Power supply

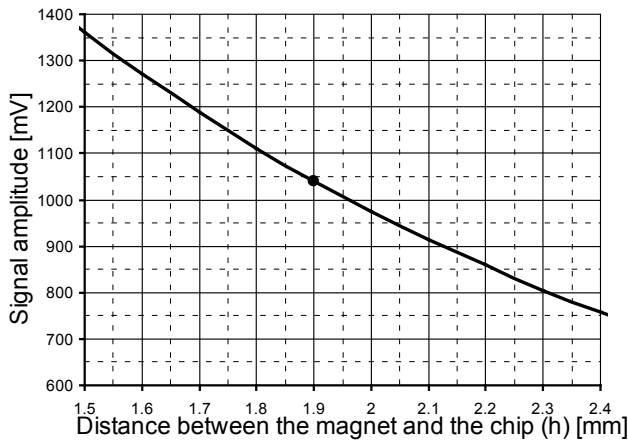

Fig. 29: Signal amplitude Vs Distance

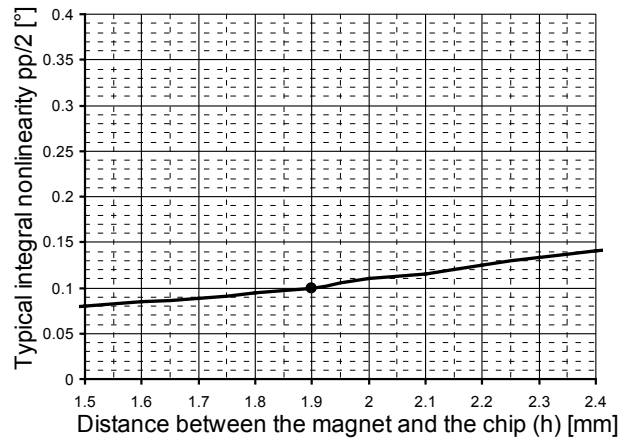

Fig. 30: Accuracy Vs Distance

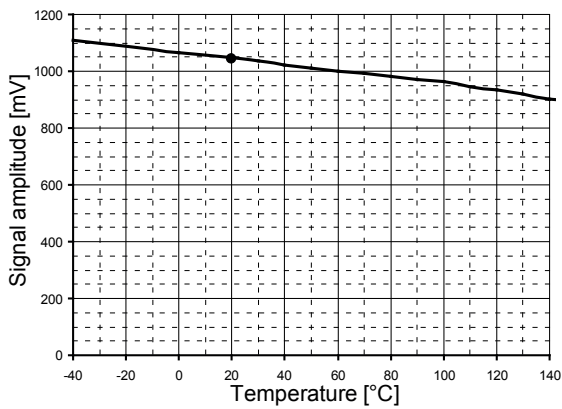

Fig. 31: Signal amplitude Vs Temperature

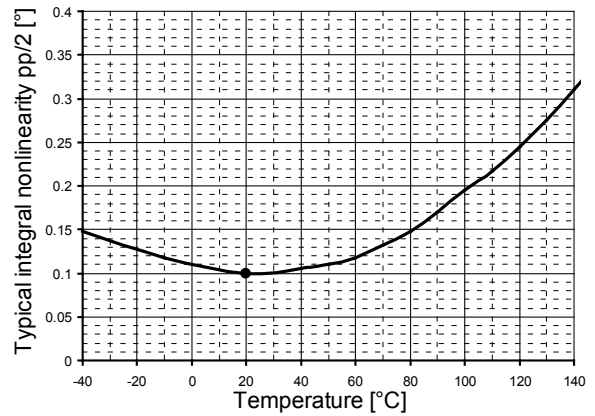

Fig. 32: Accuracy Vs Temperature

EEPROM programming

For correct operation of the AM8192B it is necessary to use an external EEPROM to hold configuration data. When the device is switched on the data from the EEPROM is transferred to the AM8192B. The EEPROM must be compatible with 24C02 with a minimum memory of 128 bytes.

The configuration of appropriate HEX files can be generated with the software designed by RLS. It can be downloaded free of charge from the RLS website (www.rls.si). The relevant configuration HEX file must be programmed into the EEPROM. Programming can be done with almost any standard programming device. The EEPROM must be programmed prior to connecting to the AM8192B because the configuration data is read during the power-up sequence.

Application scheme

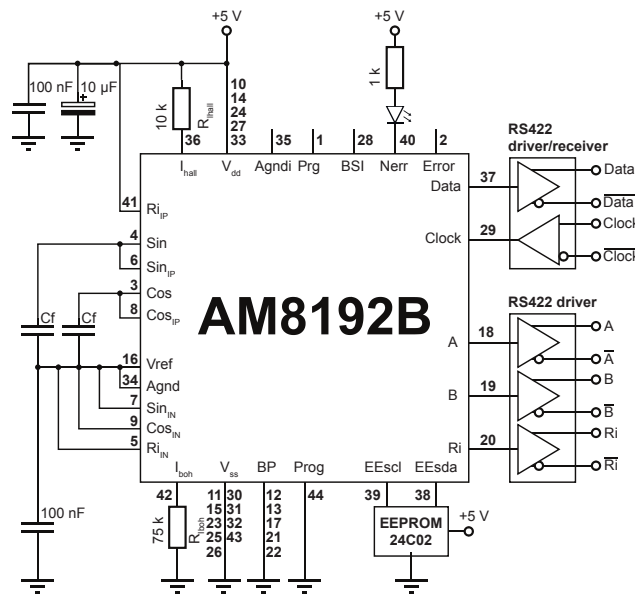

Fig. 33: Typical application scheme

LED and RS422 drivers are not necessary for correct operation of the AM8192B. Cf are filtering capacitors, recommended value is 22 nF.

LQFP44 package dimensions

Dimensions:

Symbol	Min.	Typ.	Max.	Unit
A			1.6	mm
A1	0.05		0.15	mm
A2	1.35	1.40	1.45	mm
b	0.30	0.37	0.45	mm
c	0.09		0.20	mm
D	11.80	12.00	12.20	mm
D1	9.80	10.00	10.20	mm
D3		8.00		mm
E	11.80	12.00	12.20	mm
E1	9.80	10.00	10.20	mm
E3		8.00		mm
e		0.80		mm
L	0.45	0.60	0.75	mm
L1		1.00		mm
K	0	3.5	7	deg

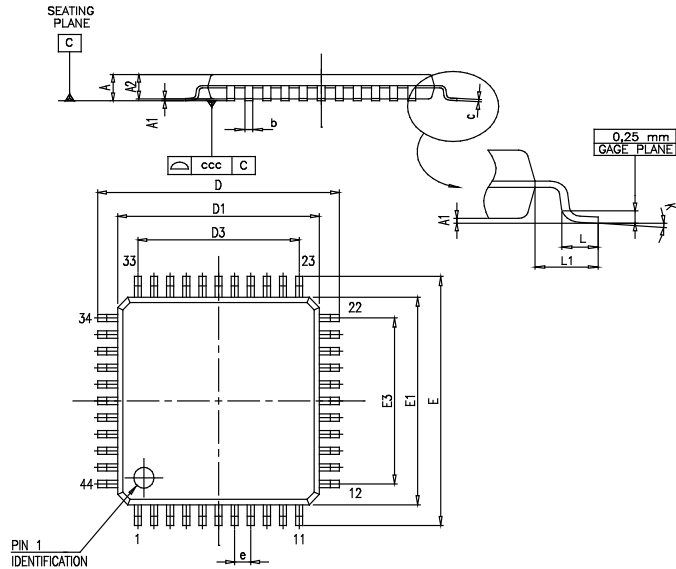



Fig. 34: LQFP44 package dimensions

Ordering information

1. Angular magnetic encoder IC

Part number	Description
AM8192B 	AM8192B angular magnetic encoder IC with default functionality Outputs: - Serial SSI - Incremental SMD package LQFP44 Delivered in trays (160 units per tray)



NOTE: Order quantity must be a multiple of 160 (one tray).

NOTE: Magnet must be ordered separately! The angular magnetic encoder IC part number does not include a magnet.

2. Magnet

Part number	Description
RMM44A3C00 	Diametrically polarized magnet Dimensions: Ø4 mm × 4 mm Packed in tubes

3. Sample kits

Part number	Description
 AM8192BKIT	AM8192B angular magnetic encoder IC with a magnet, delivered in an antistatic box Outputs: SSI, Incremental
 RMK3B	AM8192B angular magnetic encoder IC, on a PCB with all necessary components, and a magnet, delivered in an antistatic box Outputs: SSI, Incremental

RMK3B evaluation board

AM8192B angular magnetic encoder IC on a PCB with all necessary components and a magnet delivered in an antistatic box. RMK3B is evaluation board, not suitable for mass production.

Outputs: SSI, Incremental, Unbuffered Sine/Cosine with Agnd, and output for magnet displacement Error

Connections

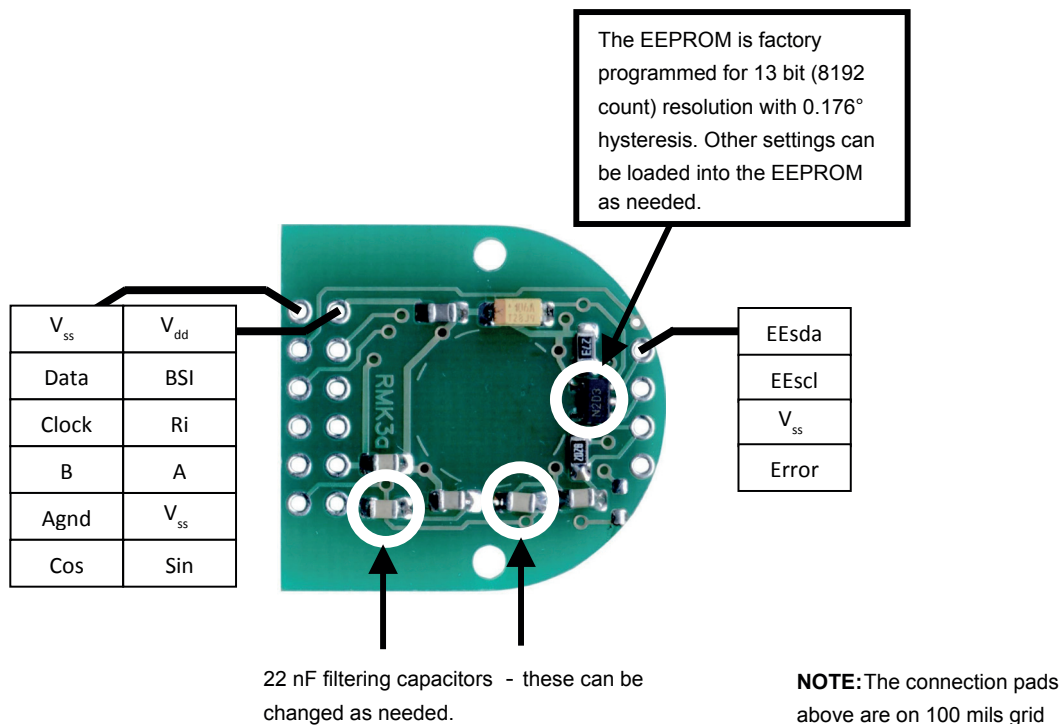

Fig. 35: RMK3B pin assignment

Dimensions

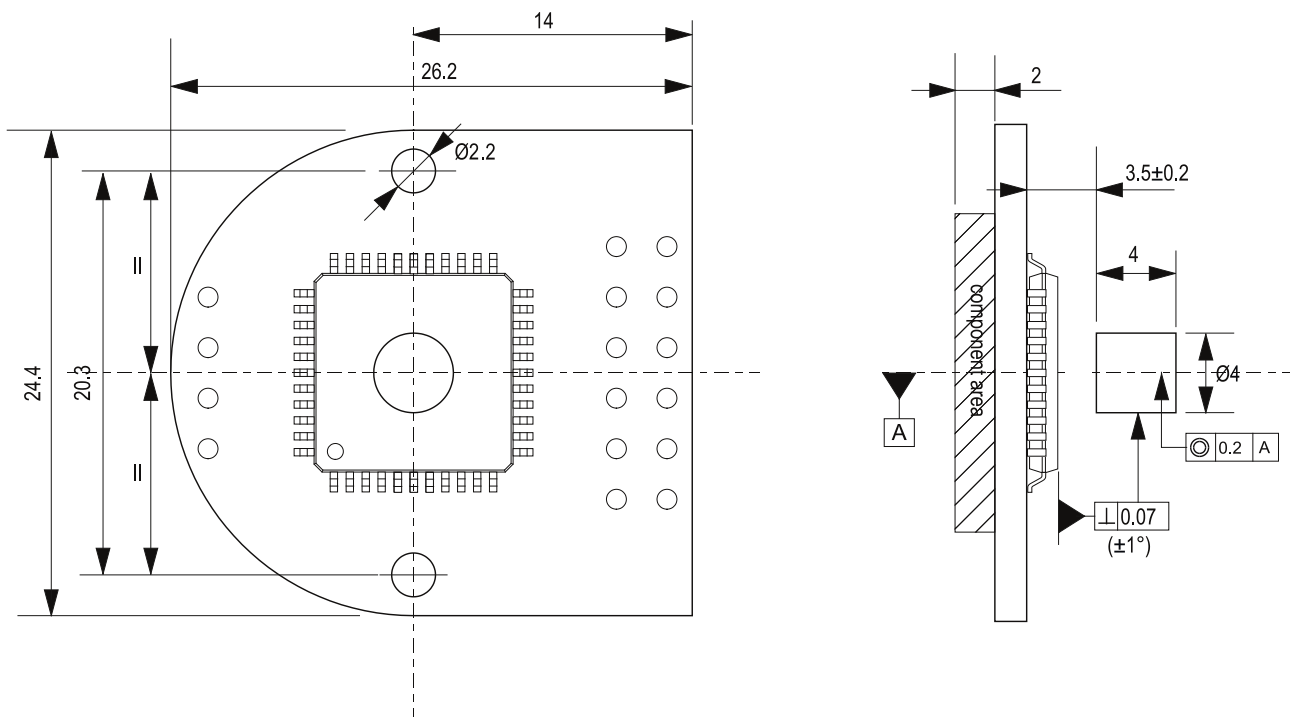

Fig. 36: Dimensional drawing with installation tolerances

NOTE: This assembly is a test/evaluation or demonstration kit and is not suitable for production or end-product installation purposes.

Head office

RLS merilna tehnika d.o.o.
 Poslovna cona Žeje pri Komendi
 Pod vrbami 2
 SI-1218 Komenda
 Slovenia

T +386 1 5272100
F +386 1 5272129
E mail@rls.si
www.rls.si

Document issues

Issue	Date	Page	Corrections made
2	25. 5. 2007	18	Application scheme updated to correct LED connection diagram
		19	Addition of ordering information and RMK3B
3	29. 6. 2007	1	Changed front page description
4	8. 11. 2007	General	Changed layout
		19	Added the LQFP44 package dimensions
		22	Corrected contact information
	15. 1. 2008	19	Added the description under the picture
5	14. 1. 2009	General	New layout
6	26. 5. 2015	-	AM8192B1 removed
7	28. 10. 2015	General	New layout
8	17. 12. 2015	3	Moisture sensitivity level added
		4	Operating range conditions table corrected

This product is not designed or intended for use outside the environmental limitations and operating parameters expressly stated on the product's datasheet. Products are not designed or intended for use in medical, military, aerospace, automotive or oil & gas applications or any safety-critical applications where a failure of the product could cause severe environmental or property damage, personal injury or death. Any use in such applications must be specifically agreed to by seller in writing, and is subject to such additional terms as the seller may impose in its sole discretion. Use of products in such applications is at buyer's own risk, and buyer will indemnify and hold harmless seller and its affiliates against any liability, loss, damage or expense arising from such use. Information contained in this datasheet was derived from product testing under controlled laboratory conditions and data reported thereon is subject to the stated tolerances and variations, or if none are stated, then to tolerances and variations consistent with usual trade practices and testing methods. The product's performance outside of laboratory conditions, including when one or more operating parameters is at its maximum range, may not conform to the product's datasheet. Further, information in the product's datasheet does not reflect the performance of the product in any application, end-use or operating environment buyer or its customer may put the product to. Seller and its affiliates make no recommendation, warranty or representation as to the suitability of the product for buyer's application, use, end-product, process or combination with any other product or as to any results buyer or its customer might obtain in their use of the product. Buyer should use its own knowledge, judgment, expertise and testing in selecting the product for buyer's application, end-use and/or operating environment, and should not rely on any oral or written statement, representation, or samples made by seller or its affiliates for any purpose. EXCEPT FOR THE WARRANTIES EXPRESSLY SET FORTH IN THE SELLER'S TERMS AND CONDITIONS OF SALE, SELLER MAKES NO WARRANTY EXPRESS OR IMPLIED WITH RESPECT TO THE PRODUCT, INCLUDING ANY WARRANTY OF MERCHANTABILITY OR FITNESS FOR ANY PARTICULAR PURPOSE, WHICH ARE DISCLAIMED AND EXCLUDED. All sales are subject to seller's exclusive terms and conditions of sale which, where the seller is (a) RLS merilna tehnika d.o.o., are available at <https://www.rls.si/customer-service>, (b) Renishaw, Inc., are available at <http://www.renishaw.com/Shop/legal/en/-42186>, or (c) another person, are available on request, and in each case, are incorporated herein by reference, and are the exclusive terms of sale. No other terms and conditions apply. Buyer is not authorized to make any statements or representations that expand upon or extend the environmental limitations and operating parameters of the products, or which imply permitted usage outside of that expressly stated on the datasheet or agreed to in writing by seller.

RLS merilna tehnika d.o.o. has made considerable effort to ensure the content of this document is correct at the date of publication but makes no warranties or representations regarding the content. RLS merilna tehnika d.o.o. excludes liability, howsoever arising, for any inaccuracies in this document. © 2018 RLS d.o.o.