

RLC2HD

Miniature Incremental Magnetic Encoder Module

MINIATURE
DESIGN

HIGH
OPERATING
SPEED

EASY
INSTALLATION
WITH
SOLDERING

RLC2HD is a PCB-level incremental encoder system consisting of a PCB sensor and a magnetic scale or ring. It is designed for embedded motion control applications as a position control loop element in applications with limited space.

The state-of-the-art position detection guarantees a highly repeatable position measurement under wide installation tolerances and temperature ranges. The position information is output in incremental quadrature format with the periodic reference mark option (each pole).

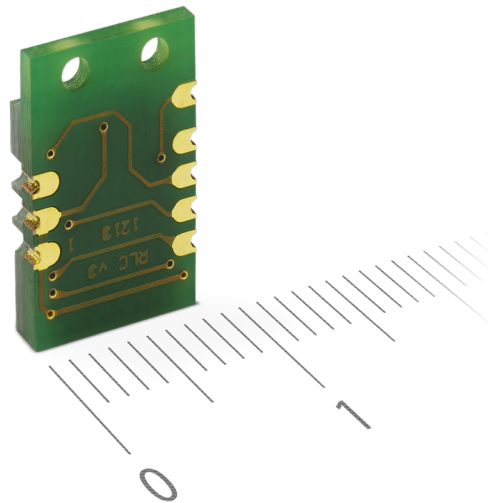

Features and benefits

- ▶ Miniature design: 8 x 2.1 x 12.5 mm
- ▶ Incremental quadrature A, B, Z (TTL)
- ▶ Periodic-bidirectional reference mark
- ▶ High-speed operation
- ▶ Suitable for use with linear scale, radial and axial rings
- ▶ SMT solder to a customer PCB board
- ▶ RoHS compliant



SMT PICK AND PLACE



IN SMALL SIZE



LINEAR MOTOR



MEDICAL



ASSEMBLY LINES

General information

The RLC2HD is a miniature rotary and linear encoder that can be used in space-constrained applications. The readhead provides a single-ended incremental signal and is ideally soldered to the customer's electronics.

Choose your RLC2HD system

The robust RLC2HD readhead is compatible with the RLS incremental scale MS05 as well as the RLS axial and radial rings. You can select the length of the MS05 scale up to 50 m. There is also a wide range of axial and radial incremental rings available. To ensure safety and reliability, the scale MS05 and the radial rings can be optionally covered with a protective stainless steel foil.

RLC2HD + magnetic scale

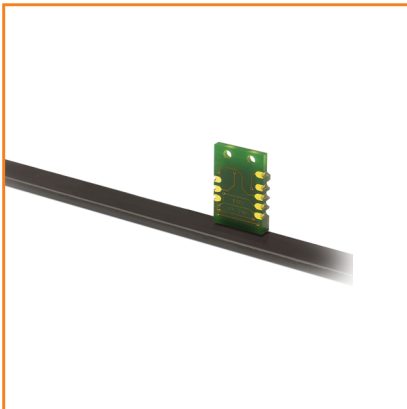

More about the MS magnetic scales can be found in the MSD01 at **RLS media center**.

RLC2HD + radial magnetic ring



More about the radial rings can be found in the MR02D02 at **RLS media center**.

RLC2HD + axial magnetic ring

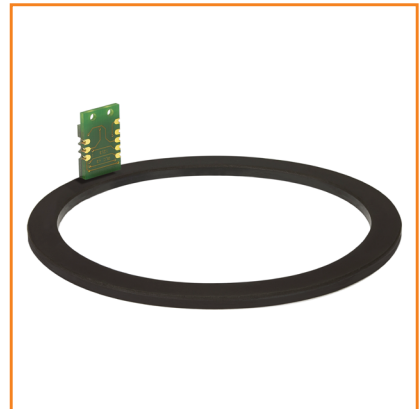

More about the axial rings can be found in the MR01D01 at **RLS media center**.

Storage and handling

All data given below refer to the readhead only. Complete systems with magnetic scale or ring may have other limitations. For more information, see the MSD01, MR02D02 or MR01D01 data sheet at [RLS Media center](#).

Storage temperature



-40 °C to +85 °C
-40 °C to +60 °C (Tape and reel packaging)

Operating temperature



-30 °C to +85 °C

Humidity



Up to 70 % non-condensing
Up to 10 % (before soldering)

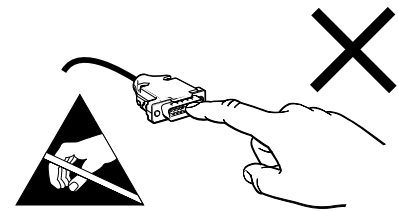
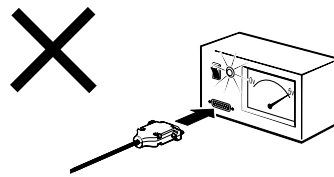
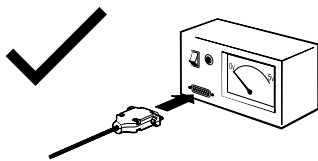

The encoder is a mechanically sensitive component. Handle it by its edges, touch it lightly, minimize pressure and eliminate bending while maintaining a secure grip to prevent falls. Maximize cleanliness. When it's not in use, place it in an ESD protective packaging (box or tray).

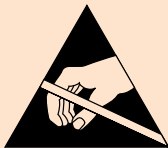

Readhead is ESD sensitive - handle with care.

Do not touch electronic circuit, wires or sensor area without proper ESD protection or outside of ESD controlled environment.

Packaging

Up to 20 pcs packaged individually in an antistatic box. 20+ units packaged in trays (max. 120 pcs per tray, 21 trays per box).

Tape and reel packaging (special option 07)

W24/P12/T0.3 in 13" reel

The minimum order quantity for reel packaging is 2000 pcs.

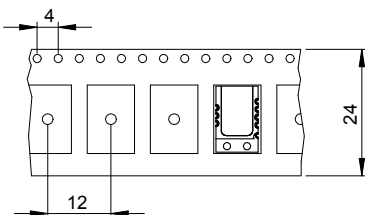

Dimensions and installation drawings

Dimensions and tolerances are in mm. Dimensions without tolerance values are in accordance with ISO 2768-m.



PCB footprint

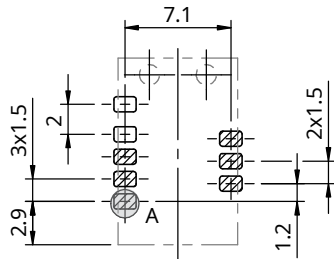

Detail A:
Valid for all 8 pads

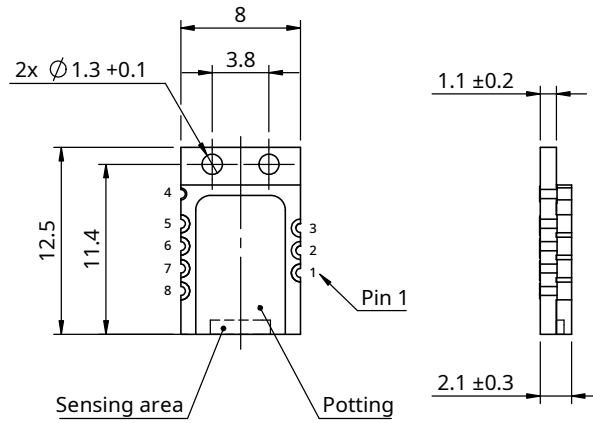
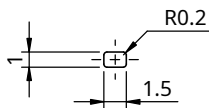

3D model available for download at [RLS Media center](#).

Installation instructions

When mounting the RLB, make sure that only the mounting surfaces of the PCB assembly are in contact with the mounting bracket. All other parts of the PCB assembly should maintain a minimum distance of 0.1 mm from other metal objects. All permissible distance and angle tolerances must be strictly complied according to the mounting instructions found at MSD01, MR01D01 or MR02D02 data sheet at [RLS Media center](#).

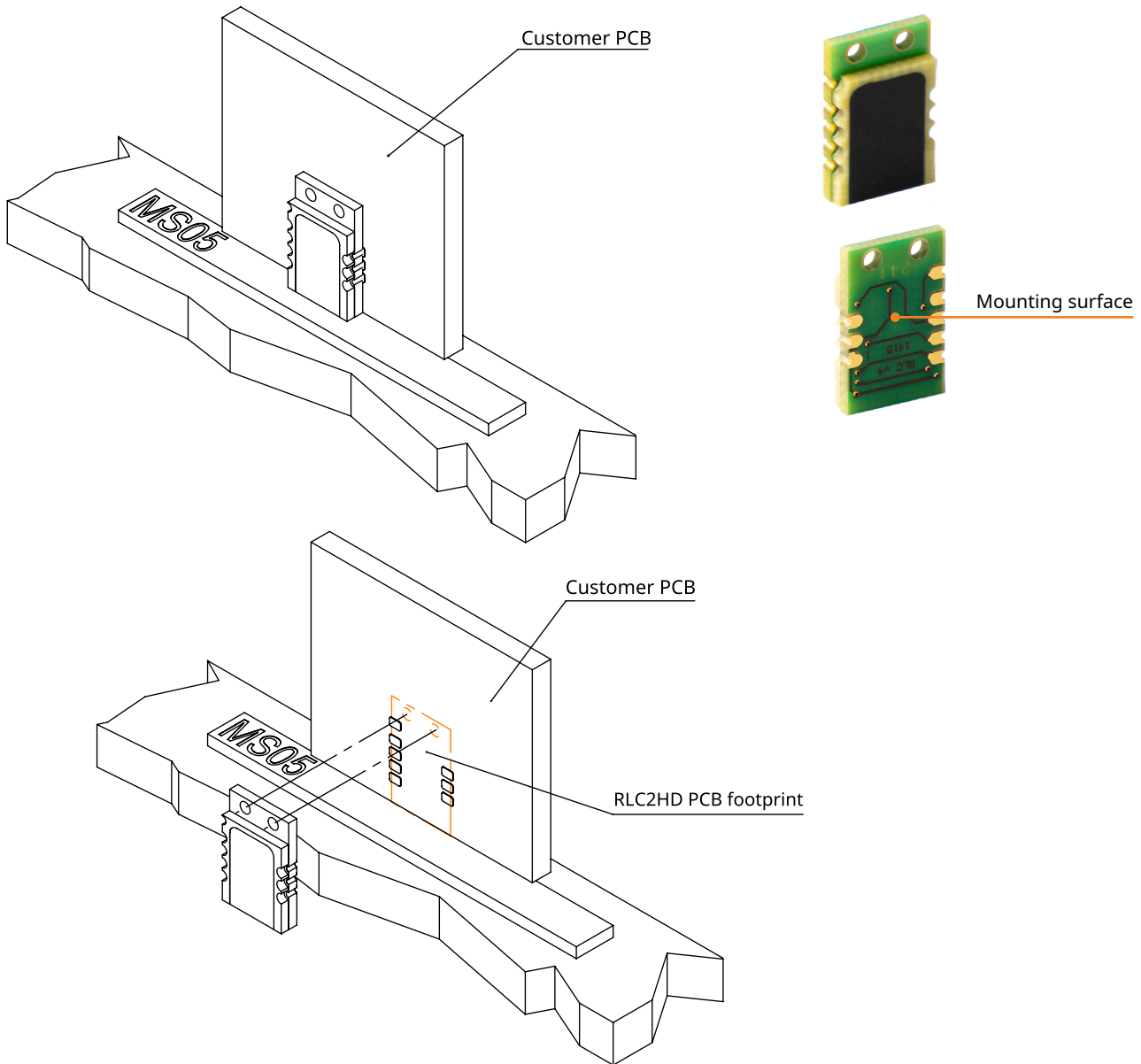

Images are for illustration purposes only. Valid for all versions.

To avoid mechanical damage to the PCB assembly, do not use countersunk fasteners.

- It is important that the space between the readhead and the magnetic scale is maintained over the entire measuring range.
- The magnetic encoder system must be used in accordance with the specified degree of protection. The following factors must be taken into account: IP protection class, operating temperature, external magnetic field, humidity level, mechanical load and EMC compatibility.
- The magnetic encoder system is sensitive to the external magnetic fields. The magnitude of the influence on the magnetic encoder system depends on the magnitude and direction of the external magnetic field. In particular, the rapidly changing stray magnetic fields affect the system and can alter its function. Magnetic field strength within 1 mT reduces the accuracy of the system. Field strengths greater than 1 mT will cause the system to malfunction and as a result the readhead will report an incorrect position. Magnetic field strengths greater than 25 mT will cause irreversible damage to the magnetic scale or ring and will have to be replaced.

Technical specifications

System data

Pole length		2 mm
Maximum measuring length		50 m
System accuracy	Linear application	$\pm 10 \mu\text{m/m}$ / $\pm 20 \mu\text{m/m}$ / $\pm 40 \mu\text{m/m}$
	MS05 magnetic scale	Different accuracy grades of MS05 magnetic scale available. Refer to MSD01 available at RLS Media center .
	Rotary application	Axial: Refer to MR01D01 available at RLS media center . Radial: Refer to MR02D02 available at RLS media center .
Hysteresis		< 3 μm (at 0.3 mm ride height)
Repeatability (unidirectional)		< 1 μm
Reference mark		Periodic
Set-up time		< 50 ms (after power supply voltage is set in operating range)
Resolution		Max. 13 bit ($\sim 0.244 \mu\text{m}$) For details refer to the Table of available resolutions .
Maximum speed	Linear application	Refer to speed calculator available at RLS website .
	Rotary application	Axial: Refer to speed calculator available at RLS website . Radial: Refer to speed calculator available at RLS website .

Electrical data

Power supply	5 V ± 0.25 V – voltage on readhead
Current consumption	< 20 mA
Reverse polarity protection	Without reverse polarity protection

Mechanical data

Mass	1.25 g
-------------	--------

Environmental data

Temperature	Operating	-30 °C to +85 °C
	Storage	-40 °C to +85 °C -40 °C to +60 °C (Tape and reel packaging)
Vibrations (55 Hz to 2000 Hz)		300 m/s ² (IEC 60068-2-6)
Shocks (6 ms)		300 m/s ² (IEC 60068-2-27)
Moisture level		MSL6 (IPC/JEDEC-J-STD-020)
Baking procedure		48 h/125 °C or according to IPC/JEDEC-J_STD_033
Humidity		70 % non-condensing
		10 % (before soldering)
External magnetic field during operation		< 1 mT
ESD immunity		HBM, Class 2 ±2kv

Reflow data

Moisture level	MSL6
Maximum reflow temperature	245 °C

Solder in 24h after bag is opened.

Electrical connections

Pin	Signal
1	Vdd
2	Vdd
3	GND
4	NC
5	NC
6	Z
7	B
8	A

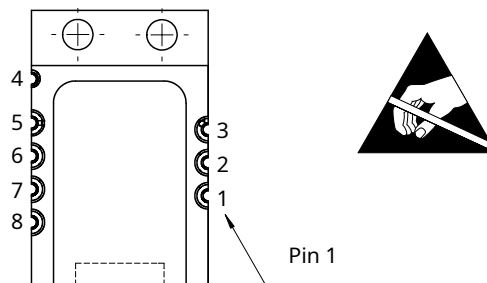

Output type

Incremental, no line driver

RLC2HD

Specifications

Output signals	Digital – TTL-level (A, B, Z)
Saturation voltage hi ($I = -4$ mA)	$V_{dd} - 0.4$ V
Saturation voltage Io ($I = 4$ mA)	0.4 V
Rise and fall time ($c_c = 50$ pF)	60 ns

Timing diagram

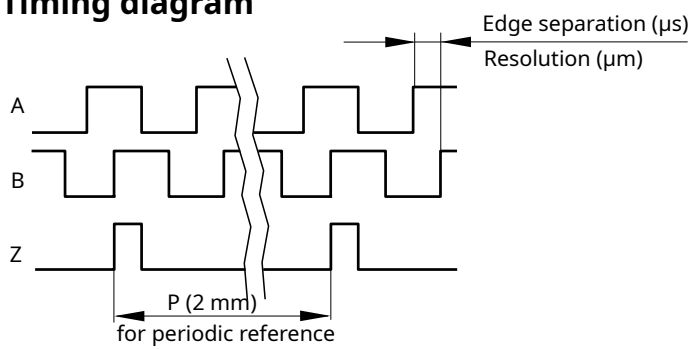

Positive direction

Digital output signals – A leads B

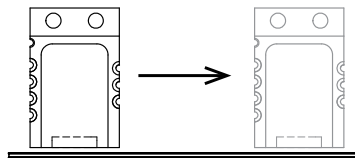

For more information, see the MSD01, MR02D02 or MR01D01 data sheet at [RLS Media center](#).

Part numbering

RLC 2 HD A 13B A 00 C 00

Pole length

2 - 2 mm

Output type

HD - Incremental, no line driver

Option

A - Standard

Interpolation factor (Resolutions)*

Max Speed Calculators

13B - 8192 (~0.244 μm)	09B - 512 (~3.906 μm)	D10 - 100 (~20 μm)
12B - 4096 (~0.488 μm)	D50 - 500 (~4 μm)	D08 - 80 (~25 μm)
11B - 2048 (~0.976 μm)	D40 - 400 (~5 μm)	06B - 64 (~31.25 μm)
D20 - 2000 (~1 μm)	D32 - 320 (~6.25 μm)	D04 - 40 (~50 μm)
1D6 - 1600 (~1.25 μm)	08B - 256 (~7.812 μm)	05B - 32 (~62.5 μm)
10B - 1024 (~1.953 μm)	D20 - 200 (~10 μm)	04B - 16 (~125 μm)
1D0 - 1000 (~2 μm)	D16 - 160 (~12.5 μm)	03B - 8 (~250 μm)
D80 - 800 (~2.5 μm)	07B - 128 (~15.625 μm)	

* For exact values see table of **Available resolutions**.

Minimum edge separation

Max Speed Calculators

K - 0.07 μs (15 MHz)	E - 4 μs (0.25 MHz)
A - 0.12 μs (8 MHz)	F - 5 μs (0.2 MHz)
B - 0.5 μs (2 MHz)	G - 10 μs (0.1 MHz)
C - 1 μs (1 MHz)	H - 20 μs (0.05 MHz)
D - 2 μs (0.5 MHz)	

The customer's controller must support the selected edge separation time even if the encoder is used below the maximum speed.

Connector

00 - No connector, through-hole

Reference mark

C - Periodic reference mark as per scale pitch (every 2 mm)
Reference periods correspond to pole length of magnetisation. Magnetic scale or ring must be ordered with no reference mark.

Special requirements

- 00 - No special requirements (standard)
- 07 - Tape and reel packaging (The minimum order quantity for reel packaging is 2000 pcs. For large quantities - see **page 3**)

Not all part number combinations are valid. Please refer to the table of available combinations on the next page for available options.

Table of available combinations

Series	Pole length	Output type	Option	Interpolation factor	Minimum edge separation	Connector	Reference mark	Special requirements
RLC	2	HD	A	xxx*	K / A / B / C / D / E / F / G / H	00	C	00 / 07
				04B	A / B / C / D / E / F / G / H			
				03B	B / C / D / E / F / G / H			

*Please check the table below for available interpolation factors.

For the part numbering of the MS incremental magnetic scale or the MR radial and axial incremental magnetic ring, refer to the MSD01, MR02D02 or MR01D01 data sheet at **RLS Media Center**.

Available resolutions

Table of available resolutions

Part number	Pole length [mm]	Interpolation factor	Resolution [µm]
13B	2	2 ¹³	0.244140625
12B		2 ¹²	0.48828125
11B		2 ¹¹	0.9765625
2D0		2000	1
1D6		1600	1.25
10B		2 ¹⁰	1.953125
1D0		1000	2
D80		800	2.5
09B		2 ⁹	3.90625
D50		500	4
D40		400	5
D32		320	6.25
08B		2 ⁸	7.8125
D20		200	10
D16		160	12.5
07B		2 ⁷	15.625
D10		100	20
D08		80	25
06B		2 ⁶	31.25
D04		40	50
05B	2 ⁵	62.5	
04B	2 ⁴	125	
03B	2 ³	250	

Resolutions calculation

$$\text{Resolution } [\mu\text{m}] = \frac{\text{Pole length } [\mu\text{m}]}{\text{Interpolation factor}} = \frac{2000}{\text{Interpolation factor}}$$

For ring applications:

CPR – Counts per revolution (resolution)

Resolution [CPR] = Pole number * x Interpolation factor

PPR – Pulses per revolution

$$\text{Resolution [PPR]} = \frac{\text{Resolution [CPR]}}{4}$$

*See pole numbers in the MR01D01 or MR02D02 data sheet at **RLS Media center**.

Accessories

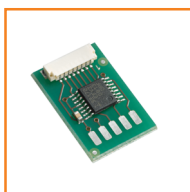

Line driver board for
incremental encoders

LDB01



USB encoder interface

E201-9Q

E201-9Q should be used with adapter to transfer from single ended to differential.

Head office

RLS Merilna tehnika d. o. o.

Poslovna cona Žeje pri Komendi
Pod vrbami 2
SI-1218 Komenda
Slovenia

T +386 1 5272100
E mail@rls.si

www.rls.si

Global support

Visit our [website](#) to contact your nearest sales representative.

Date	Issue	Page	Description
19. 12. 2022	4	General	New design, data amended
		6	Installation instructions data added
7. 4. 2023	5	8	Output type specifications amended
15. 9. 2023	6	9	Menu (button) Max Speed Calculators added
13. 10. 2023	7	6	Set-up time amended
		3, 9	Minimum order quantity for reel packaging added
15. 7. 2024	8	11	LDB01 added
4. 9. 2024	9	3, 7	Environmental data amended

This product is not designed or intended for use outside the environmental limitations and operating parameters expressly stated on the product's datasheet. Products are not designed or intended for use in medical, military, aerospace, automotive or oil & gas applications or any safety-critical applications where a failure of the product could cause severe environmental or property damage, personal injury or death. Any use in such applications must be specifically agreed to by seller in writing, and is subject to such additional terms as the seller may impose in its sole discretion. Use of products in such applications is at buyer's own risk, and buyer will indemnify and hold harmless seller and its affiliates against any liability, loss, damage or expense arising from such use. Information contained in this datasheet was derived from product testing under controlled laboratory conditions and data reported thereon is subject to the stated tolerances and variations, or if none are stated, then to tolerances and variations consistent with usual trade practices and testing methods. The product's performance outside of laboratory conditions, including when one or more operating parameters is at its maximum range, may not conform to the product's datasheet. Further, information in the product's datasheet does not reflect the performance of the product in any application, end-use or operating environment buyer or its customer may put the product to. Seller and its affiliates make no recommendation, warranty or representation as to the suitability of the product for buyer's application, use, end-product, process or combination with any other product or as to any results buyer or its customer might obtain in their use of the product. Buyer should use its own knowledge, judgment, expertise and testing in selecting the product for buyer's application, end-use and/or operating environment, and should not rely on any oral or written statement, representation, or samples made by seller or its affiliates for any purpose. EXCEPT FOR THE WARRANTIES EXPRESSLY SET FORTH IN THE SELLER'S TERMS AND CONDITIONS OF SALE, SELLER MAKES NO WARRANTY EXPRESS OR IMPLIED WITH RESPECT TO THE PRODUCT, INCLUDING ANY WARRANTY OF MERCHANTABILITY OR FITNESS FOR ANY PARTICULAR PURPOSE, WHICH ARE DISCLAIMED AND EXCLUDED. All sales are subject to seller's exclusive terms and conditions of sale which, where the seller is (a) RLS Merilna tehnika d. o. o., are available at <https://www.rls.si/eng/salesterms>, (b) Renishaw, Inc., are available at <https://www.renishaw.com/legal/en/-42186>, or (c) another person, are available on request, and in each case, are incorporated herein by reference, and are the exclusive terms of sale. No other terms and conditions apply. Buyer is not authorized to make any statements or representations that expand upon or extend the environmental limitations and operating parameters of the products, or which imply permitted usage outside of that expressly stated on the datasheet or agreed to in writing by seller.

RLS Merilna tehnika d. o. o. has made considerable effort to ensure the content of this document is correct at the date of publication but makes no warranties or representations regarding the content. RLS Merilna tehnika d. o. o. excludes liability, howsoever arising, for any inaccuracies in this document. © 2024 RLS d. o. o.