

# RMB28 / RMF44 / RMF58

## Rotary Magnetic Encoders

14 BIT

EASY  
MOUNTING

NUMEROUS  
OUTPUT  
OPTIONS

The RMB28 encoder module is designed for direct integration into high volume OEM applications.

The inexpensive 28 mm square PCB can also be supplied with a connector or as RMF44/RMF58 on a metal flange with 44 mm or 58 mm diameters for easy mounting. The RMB28/RMF44/RMF58 encoder modules can be used in a wide range of OEM applications, including motor control and industrial automation.

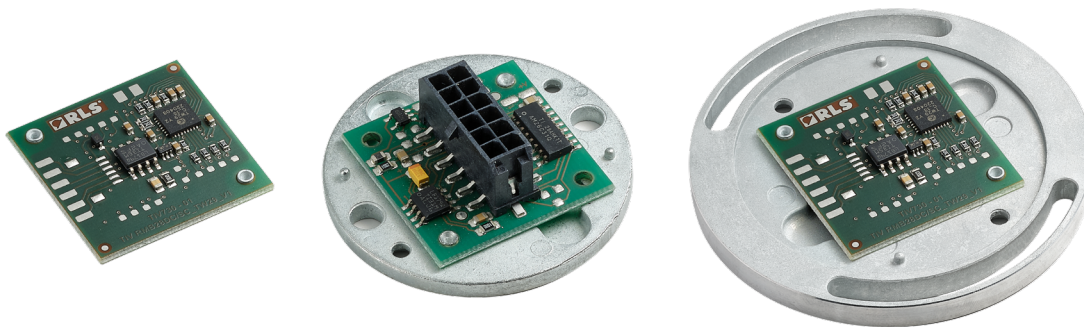

## Features and benefits

- ▶ 5 V and 24 V power supply versions
- ▶ High speed operation to 60,000 rpm
- ▶ Absolute - to 14 bit resolution (16,384 counts per revolution)
- ▶ Accuracy up to  $\pm 0.5^\circ$
- ▶ Inexpensive solution for OEM integration
- ▶ Industry standard absolute, incremental, analogue, commutation and linear voltage output formats



MOTOR CONTROL



PRINTING



MARINE



MEDICAL



INDUSTRIAL AUTOMATION

## General information

The encoder module consists of a magnetic actuator and a separate sensor board. The rotation of the magnetic actuator is detected and processed by a custom encoder chip mounted on the sensor board to obtain the desired output format. The output signals are provided in industry standard absolute, incremental, analog or linear voltage output formats.

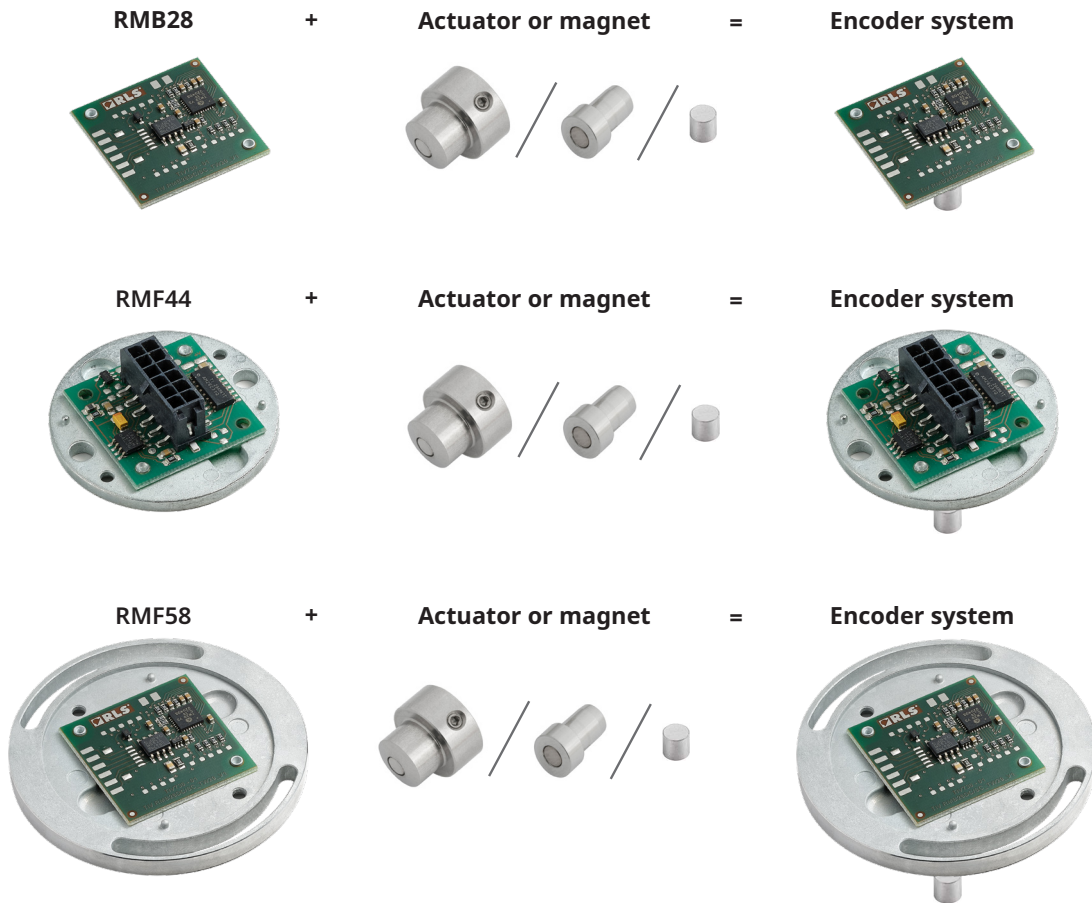

For commutation outputs please refer to [Commutation and incremental magnetic encoder solutions](#).

## Product range

### AC

Analogue sinusoidal output with a single sine/cosine period per revolution.

### DC

BiSS-C interface with up to 16,384 positions per revolution and optional revolution counter.

### I

Incremental with up to 4,096 pulses per revolution (320 to 16,384 counts per revolution with 4× evaluation).

### SC

Synchro serial interface (SSI) with up to 16,384 positions per revolution.

### SI

Synchro serial interface (SSI) with 320 to 8,192 positions per revolution and incremental with 80 to 2,048 pulses per revolution (320 to 8,192 counts per revolution with x 4 evaluation).

### Vx

Linear voltage output in a range of variants.

## Selection guide

Product	Available outputs	Power supply	
		5 V	24 V
RMB28 / RMF44 / RMF58	AC - Analogue sinusoidal outputs	✓	-
	DC - Absolute natural binary BiSS-C interface, RS422	✓	-
	IB - Incremental, open collector NPN	-	✓
	IC - Incremental, RS422	✓	-
	IE - Incremental, open collector	✓	-
	SC - Absolute binary synchro-serial interface (SSI), RS422	✓	-
	SI - Absolute binary synchro-serial (SSI) + Incremental, RS422	✓	-
	Vx - Linear voltage output	✓	-

## Storage and handling

### Operating and storage temperature



-40 °C to +125 °C  
-40 °C to +105 °C (with connector)

### Humidity



Up to 70 % non-condensing

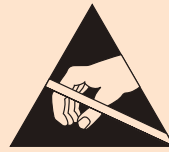
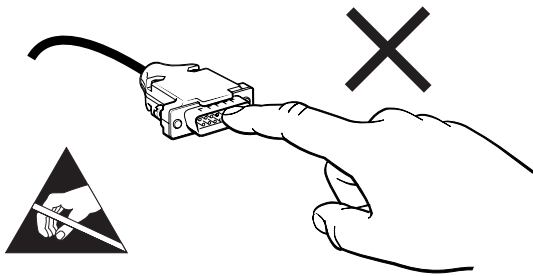

**Readhead is ESD sensitive - handle with care.**

Do not touch electronic circuit, wires or sensor area without proper ESD protection or outside of ESD controlled environment.

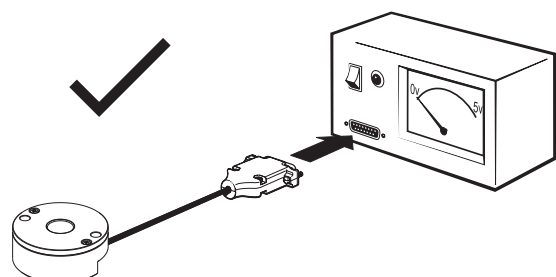
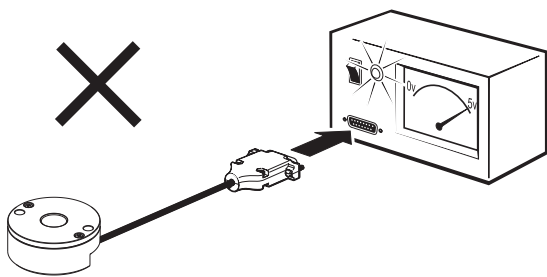

## Packaging

Less than 20 products are packed individually in an antistatic box. If the order quantity is 20 systems and larger, the parts are packed in antistatic plastic trays. Magnets and readheads are packed separately.

# Dimensions and installation drawings

Dimensions and tolerances are in mm. Dimensions without tolerance values are in accordance with ISO 2768-m.



## RMB28

### Dimensions

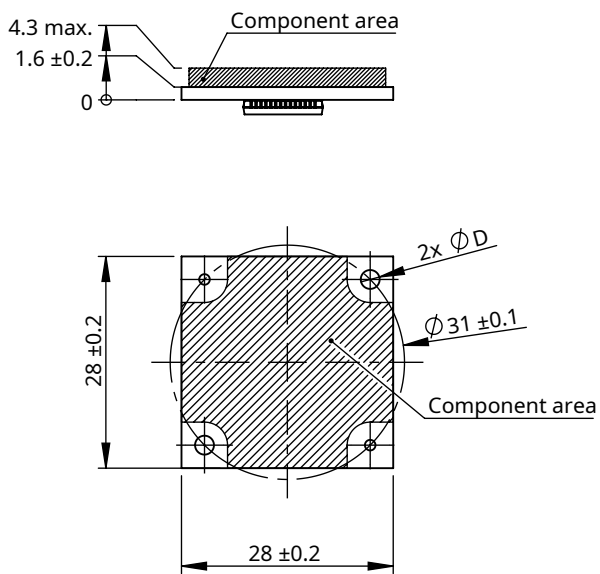

Output type	Hole diameter (D)
AC	2.5 <sup>±0.1</sup>
DC	2.5 <sup>±0.1</sup>
IC	2.5 <sup>±0.1</sup>
IB	3.5 <sup>±0.1</sup>
IE	3.5 <sup>±0.1</sup>
SC	2.5 <sup>±0.1</sup>
SI	2.5 <sup>±0.1</sup>
Vx	3.5 <sup>±0.1</sup>

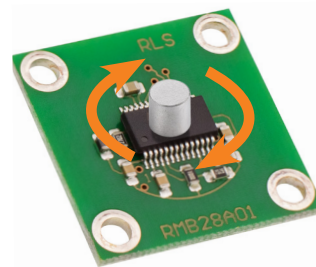

Clockwise (CW) rotation of magnet

### Installation drawing

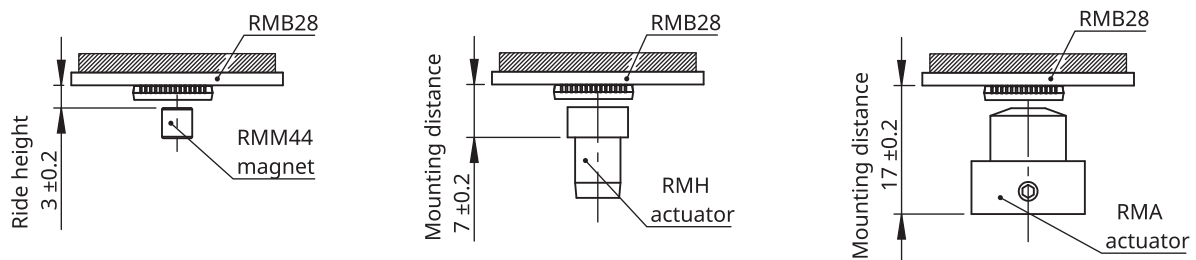

# RMF44

## Dimensions

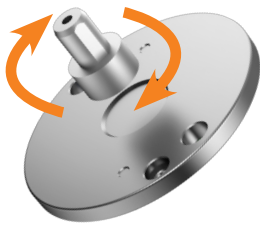
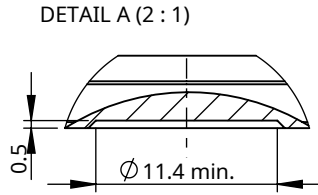
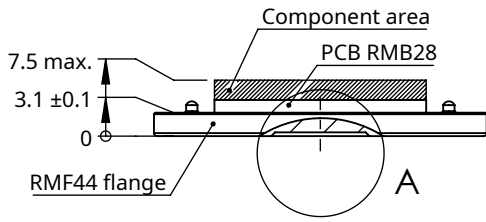

Clockwise (CW) rotation of magnet

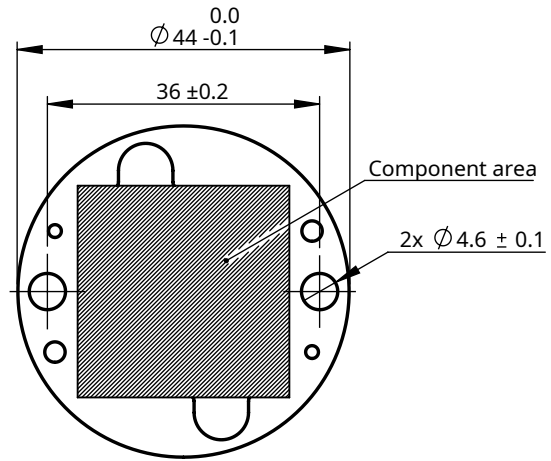

## Installation drawing

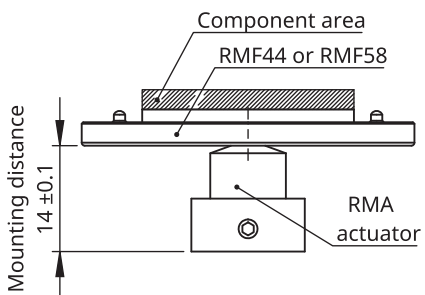
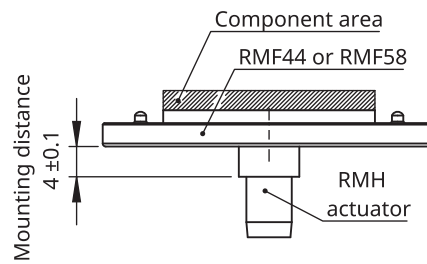
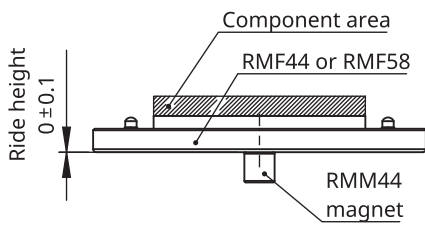

**RMF58**

**Dimensions**

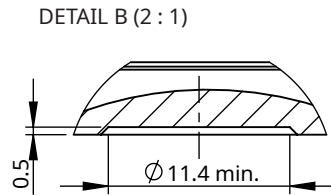
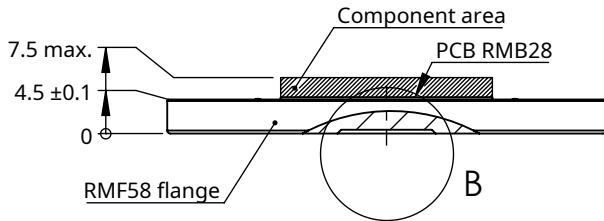

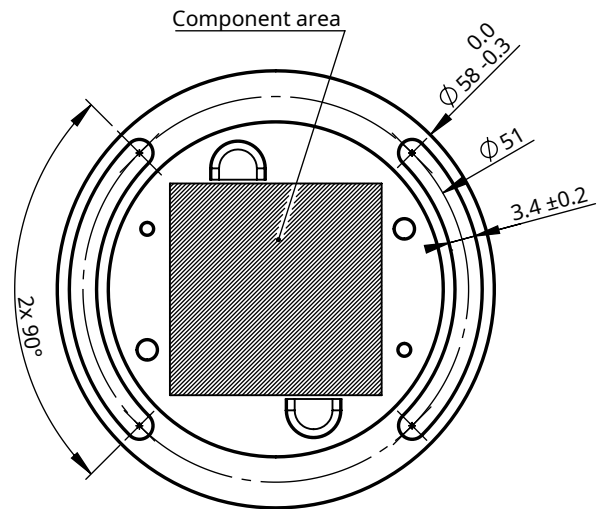

Clockwise (CW) rotation of magnet

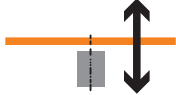
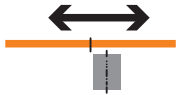

## Installation tolerances

### Installation tolerances for RMB28 / RMF44 / RMF58

<b>Mounting distance</b>	See installation drawings of encoder assemblies on <b>page 5 and 6.</b>	
<b>Radial displacement (concentricity)</b>	0.2 mm	
<b>Perpendicularity</b>	0.2°	

 - Encoder    ■ - Magnet

## Technical specifications

### Mechanical data

<b>Mass</b>	Encoder unit <20 g Magnetic actuator <2 g
<b>Magnet material</b>	Sm2Co17 with Ni-Cu-Ni protective layer
<b>Actuator material</b>	RMH: Aluminium RMA: Stainless steel

### Environmental data

<b>EMC compliance</b>	EN 61326
<b>Shock</b>	100 G (6 ms, standard EN 60068-2-27:2009)
<b>Vibration</b>	40 G (55 Hz–2000 Hz, standard EN 60068-2-6:2008)
<b>Temperature drift error</b>	0.004°/°C



# Output types

## AC – Analogue sinusoidal outputs

2 channels  $V_A$   $V_B$  sinusoids (90° phase shifted, single ended)

### Connections

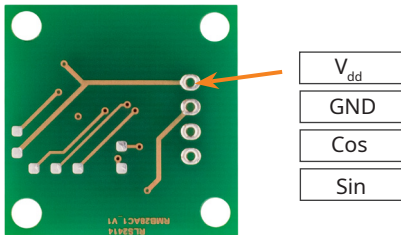

### Specifications

<b>Power supply</b>	$V_{dd} = 5\text{ V} \pm 5\%$
<b>Resolution</b>	One sine/cosine wave per revolution
<b>Current consumption</b>	13 mA
<b>Sin/Cos outputs</b>	Signal amplitude: $1.1\text{ V} \pm 0.2\text{ V}$ Signal offset: $\frac{3}{5} V_{dd} \pm 5\text{ mV}$
<b>Maximum speed</b>	60,000 rpm
<b>Operating temperature</b>	-40 °C to +125 °C

### Timing diagram

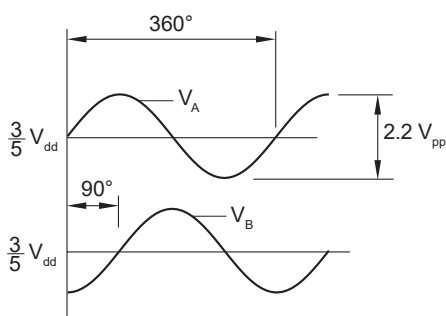

$V_A$  leads  $V_B$  by 90° for clockwise rotation of magnetic actuator.

## DC – Absolute encoder with BiSS-C interface

### Connections

Board A

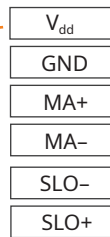
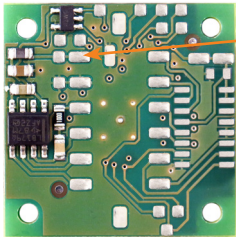

Board B

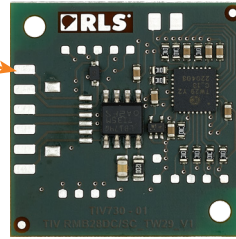

Board A, with connector

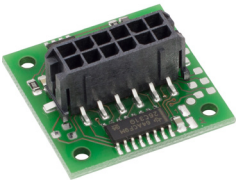

**Connector type**  
Molex 43045-1219  
**Mating connector** (Not provided)  
Molex 43025-1200 (crimp terminal  
43030-xxxx)

Board B, with connector

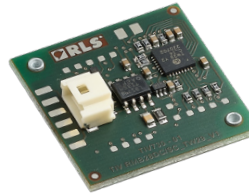

**Connector type**  
Molex 501568-0607  
**Mating connector** (Not provided)  
Shell: Molex 501330-0600  
Crimp terminal: Molex 501334-xxxx

### Specifications

<b>Output code</b>	Natural binary
<b>Power supply</b>	V <sub>dd</sub> = 5 V ±5 %
<b>Current consumption</b>	<b>Board A:</b> 35 mA <b>Board B:</b> 65 mA
<b>Clock input</b>	MA (RS422)
<b>Data output</b>	SLO (RS422)
<b>Accuracy</b>	Typ. ±0.5°
<b>Hysteresis</b>	0.18°
<b>Resolution</b>	<b>Board A:</b> 320, 400, 500, 512, 800, 1000, 1024, 1600, 2000, 2048, 4096, 8192 positions per revolution <b>Board B:</b> 360, 3600, 4000, 8000, 10000, 16000, 16384 positions per revolution*
<b>Revolution counter</b>	12 bit (4,096 revolutions)
<b>Maximum speed</b>	30,000 rpm
<b>Operating temperature</b>	-40 °C to +125 °C -40 °C to +105 °C (with connector)
<b>Max MA frequency</b>	8 MHz

\* For other resolutions [contact RLS](#).

## Timing diagram - BiSS C

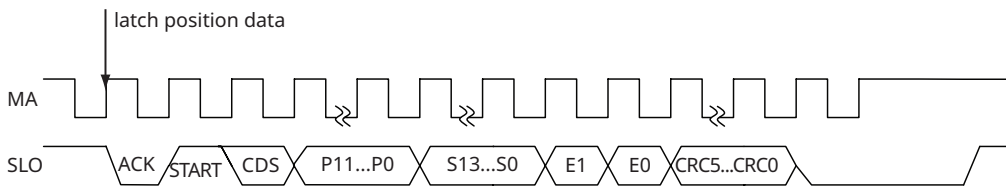

Data	Length	Description
P11 - P0	0 or 12 bit	Revolution counter value when enabled (see Part numbering/resolution)*
S13 - S0	7 to 14 bit	Position inside the revolution (length depends on the resolution)
E1 - E0	2 bit	Error data
CRC5 - CRC0	6 bit	Cyclic redundancy check data; polynomial 0x43; inverted bit output

\* The revolution counter counts the number of mechanical revolutions of the shaft or magnet of the encoder. Counting is possible only when the encoder is powered. When the encoder is powered off, the revolution counter is reset to 0.

Error	E0	E1
No error	1	1
Amplitude error	0	1
Too high velocity	1	0
Undervoltage; Configuration; System error	0	0

For more information on BiSS C protocol please visit [www.biss-interface.com](http://www.biss-interface.com).

## Recommended signal termination

For data output lines only

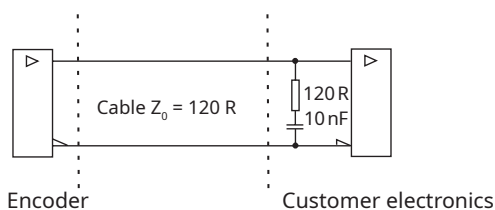

## IB – Incremental, open collector NPN

Square wave output

### Connections

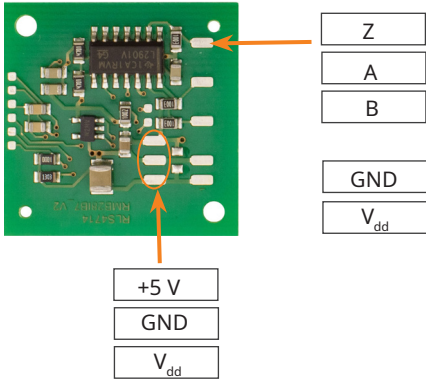

### Recommended signal termination

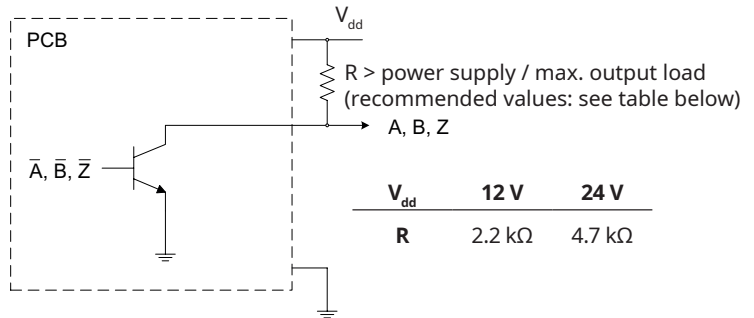

RMB28IB / RMF44IB boards need 2 power supplies; pad V<sub>dd</sub> and pad +5 V. Pads V<sub>dd</sub>, GND and +5 V have been provided to allow easy connection to a 3 terminal voltage regulator to generate 5 V from V<sub>dd</sub>.

### Specifications

<b>Power supply</b>	V <sub>dd</sub> = 8 V to 26 V
<b>Current consumption</b>	50 mA
<b>Output signals</b>	A, B, Z
<b>Maximum output load</b>	20 mA
<b>Accuracy</b>	Typ. ±0.5°
<b>Hysteresis</b>	0.18°
<b>Resolution</b>	80 to 2,048 pulses per revolution (320, 400, 500, 512, 800, 1000, 1024, 1600, 2000, 2048, 4096, 8192 counts per revolution)
<b>Maximum speed</b>	30,000 rpm
<b>Operating temperature</b>	-40 °C to +125 °C

### Timing diagram

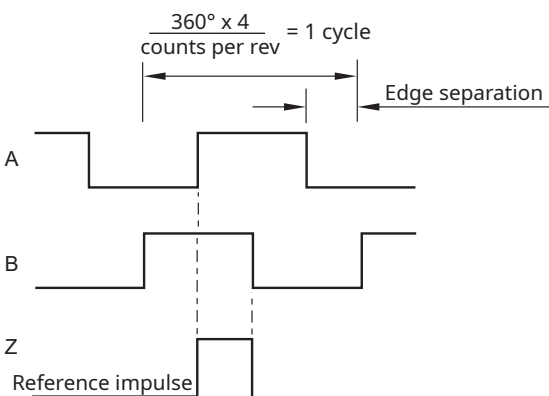

B leads A for clockwise rotation of magnetic actuator.

# IC – Incremental, RS422

Square wave differential line driver to RS422

## Connections

### Board A

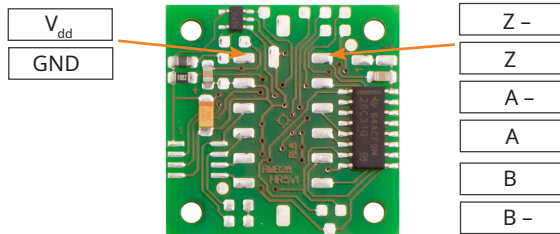

### Board B

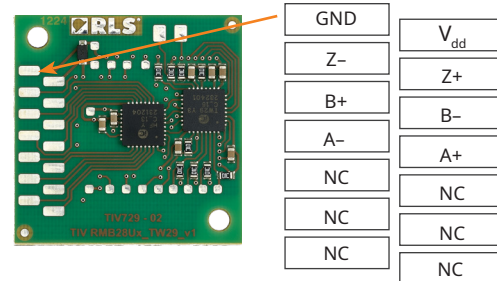

### Board A, with connector



**Connector type**  
Molex 43045-1219  
**Mating connector** (Not provided)  
Molex 43025-1200 (crimp terminal 43030-xxxx)

### Board B, with connector



**Connector on board**  
Molex 501568-1107  
**Mating connector** (Not provided)  
**Shell:** Molex 501330-1100  
**Crimp terminal:** Molex 501334-xxxx

## Specifications

<b>Power supply</b>	$V_{dd} = 5\text{ V} \pm 5\%$
<b>Current consumption</b>	<b>Board A:</b> 35 mA <b>Board B:</b> 65 mA
<b>Output signals</b>	A, B, Z, A-, B-, Z- (RS422)
<b>Accuracy</b>	Typ. $\pm 0.5^\circ$
<b>Hysteresis</b>	$0.18^\circ$
<b>Resolution</b>	<b>Board A:</b> 320, 400, 500, 512, 800, 1000, 1024, 1600, 2000, 2048, 4096, 8192 counts per revolution <b>Board B:</b> 360, 3600, 4000, 8000, 10000, 16000, 16384 counts per revolution*
<b>Maximum speed</b>	30,000 rpm
<b>Operating temperature</b>	$-40\text{ }^\circ\text{C}$ to $+125\text{ }^\circ\text{C}$ $-40\text{ }^\circ\text{C}$ to $+105\text{ }^\circ\text{C}$ (with connector)

\* For other resolutions **contact RLS**.

## Timing diagram

Complementary signals not shown

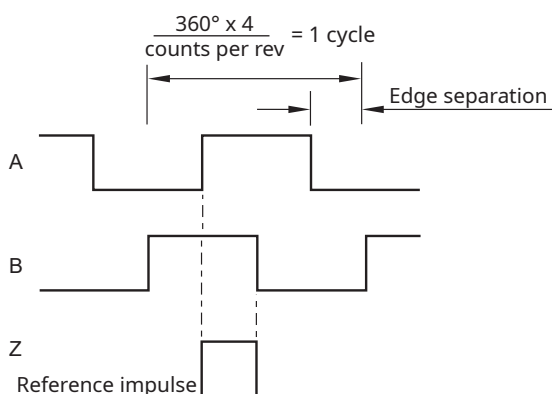

B leads A for clockwise rotation of magnetic actuator.

## Recommended signal termination

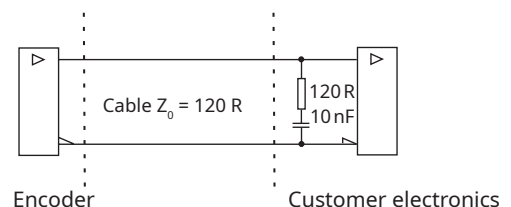

## IE – Incremental, open collector, NPN

Low cost alternative for ball bearing encoders

### Connections

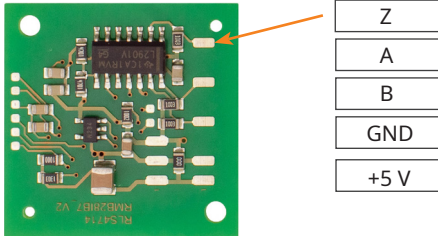

### Specifications

<b>Power supply</b>	$V_{dd} = 5\text{ V} \pm 5\%$
<b>Current consumption</b>	35 mA (not loaded)
<b>Output signals</b>	A, B, Z
<b>Maximum output load</b>	20 mA
<b>Accuracy</b>	Typ. $\pm 0.5^\circ$
<b>Hysteresis</b>	0.18°
<b>Resolution</b>	320, 400, 500, 512, 800, 1000, 1024, 1600, 2000, 2048, 4096, 8192 counts per revolution
<b>Maximum speed</b>	30,000 rpm
<b>Operating temperature</b>	-40 °C to +125 °C

### Timing diagram

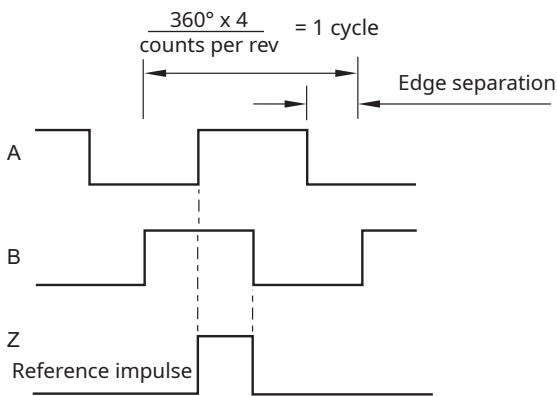

B leads A for clockwise rotation of magnetic actuator.

### Recommended signal termination

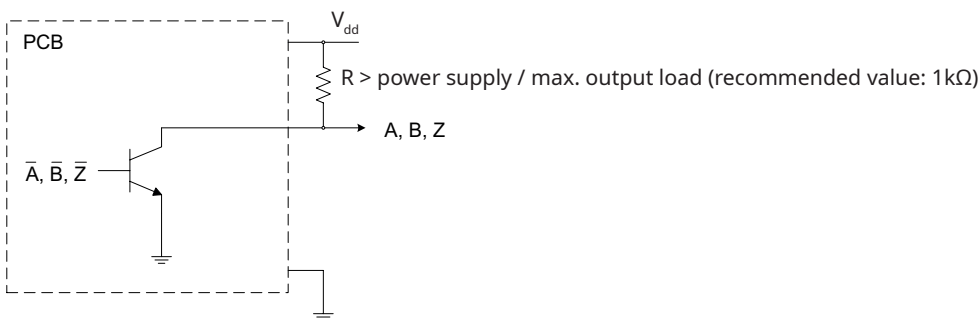

## SC – Absolute binary synchro-serial (SSI), RS422

Serial encoded absolute position measurement

### Connections

Board A

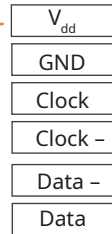
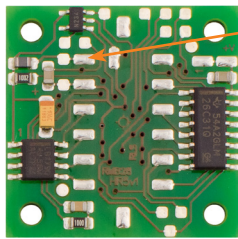

Board B

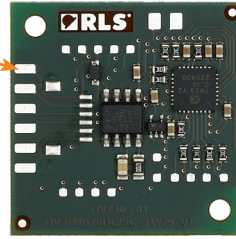

Board A, with connector

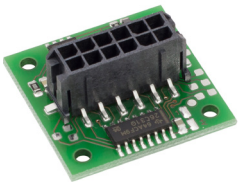

**Connector type**  
Molex 43045-1219  
**Mating connector** (Not provided)  
Molex 43025-1200 (crimp terminal  
43030-xxxx)

Board B, with connector

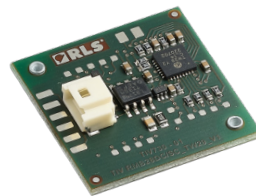

**Connector on board**  
Molex 501568-1107  
**Mating connector** (Not provided)  
**Shell:** Molex 501330-1100  
**Crimp terminal:** Molex 501334-xxxx

### Specifications

<b>Output code</b>	Natural binary
<b>Power supply</b>	$V_{dd} = 5\text{ V} \pm 5\%$
<b>Current consumption</b>	<b>Board A:</b> 35 mA <b>Board B:</b> 65 mA
<b>Data output</b>	Serial data (RS422)
<b>Data input</b>	Clock (RS422)
<b>Accuracy</b>	Typ. $\pm 0.5^\circ$
<b>Hysteresis</b>	$0.18^\circ$
<b>Resolution</b>	<b>Board A:</b> 320, 400, 500, 512, 800, 1000, 1024, 1600, 2000, 2048, 4096, 8192 positions per revolution <b>Board B:</b> 360, 3600, 4000, 8000, 10000, 16000, 16384 positions per revolution*
<b>Maximum speed</b>	30,000 rpm
<b>Operating temperature</b>	$-40\text{ }^\circ\text{C}$ to $+125\text{ }^\circ\text{C}$ $-40\text{ }^\circ\text{C}$ to $+105\text{ }^\circ\text{C}$ (with connector)

\* For other resolutions [contact RLS](#).

### Timing diagram

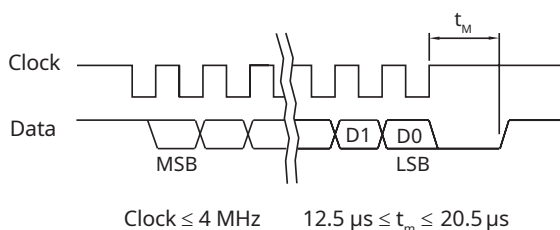

Position increases for clockwise rotation of magnetic actuator.

### Recommended signal termination

For data output lines only

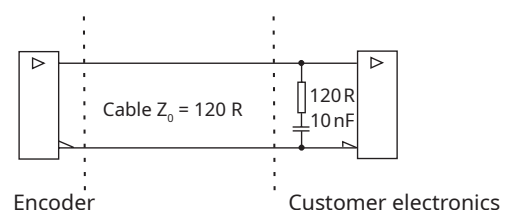

## SI – Absolute binary synchro-serial (SSI) + Incremental, RS422

Complex feedback device for absolute position at start up as well as during operation + incremental outputs.  
Both the incremental and the SSI output always have the same fixed resolution.

### Connections

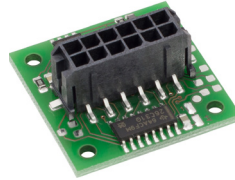
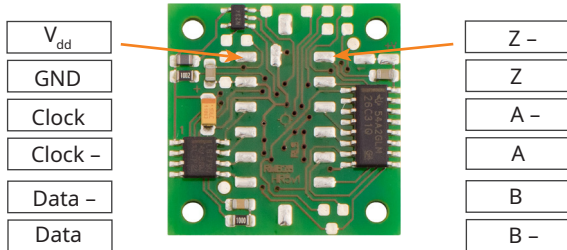

**Connector type**

Molex 43045-1219

**Mating connector** (Not provided)  
Molex 43025-1200 (crimp terminal 43030-xxxx)

### Specifications

<b>Output code</b>	Natural binary
<b>Power supply</b>	$V_{dd} = 5\text{ V} \pm 5\%$
<b>Current consumption</b>	Max. 35 mA
<b>Incremental outputs</b>	A, B, Z, A-, B-, Z- (RS422)
<b>Data output</b>	Serial data (RS422)
<b>Data input</b>	Clock (RS422)
<b>Accuracy</b>	Typ. $\pm 0.5^\circ$
<b>Hysteresis</b>	$0.18^\circ$
<b>Resolution</b>	320, 400, 500, 512, 800, 1000, 1024, 1600, 2000, 2048, 4096, 8192 counts per revolution
<b>Maximum speed</b>	30,000 rpm
<b>Operating temperature</b>	$-40^\circ\text{C}$ to $+125^\circ\text{C}$ $-40^\circ\text{C}$ to $+105^\circ\text{C}$ (with connector)

### Timing diagram - Incremental

Complementary signals not shown

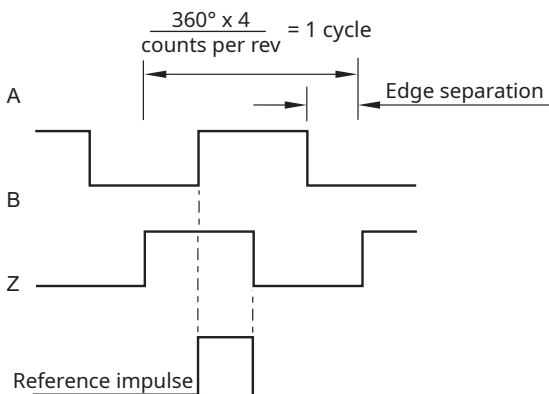

B leads A for clockwise rotation of magnetic actuator.

### Timing diagram - SSI

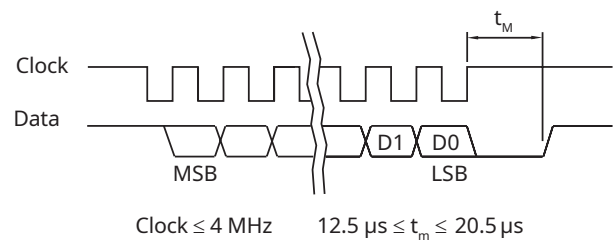

Position increases for clockwise rotation of magnetic actuator.

### Recommended signal termination

For incremental signals + SSI data output lines only

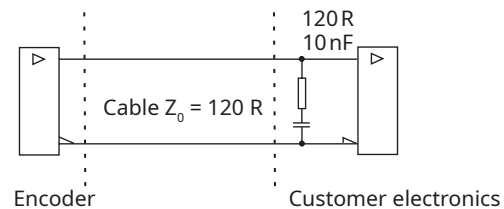



## Vx – Linear voltage output

Alternative for potentiometers

### Connections

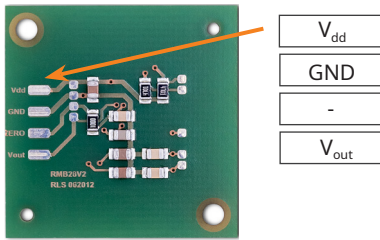

### Specifications

<b>Power supply</b>	$V_{dd} = 5\text{ V} \pm 5\%$
<b>Current consumption</b>	Typ. 26 mA
<b>Output voltage</b>	0 V to $V_{dd}$
<b>Output loading</b>	Max. 2 mA
<b>Nonlinearity</b>	1 %
<b>Resolution of DAC</b>	10 bit
<b>Maximum speed</b>	30,000 rpm
<b>Operating temperature</b>	-40 °C to +125 °C

The digital relative angular position information is converted into linear voltage with a built-in 10 bit D/A converter. The linear output voltage swing ranges from 0 V and  $V_{dd}$  (5 V). The number of periods within one revolution ( $N_{\text{period}}$ ) can be 1, 2, 4 or 8, representing one full swing over an angle ( $\varphi_{\text{period}}$ ) of 360°, 180°, 90° or 45° respectively. The signal is made up of steps which represent the angular movement needed to register a change in the position ( $\varphi_{\text{step}}$ ) and the resulting change in the output voltage ( $V_{\text{step}}$ ). The number of steps in one period ( $N_{\text{step}}$ ) is given in the table below.

For clockwise rotation of the magnetic actuator, the output voltage increases. For counterclockwise rotation, the output voltage decreases.

### Timing diagram

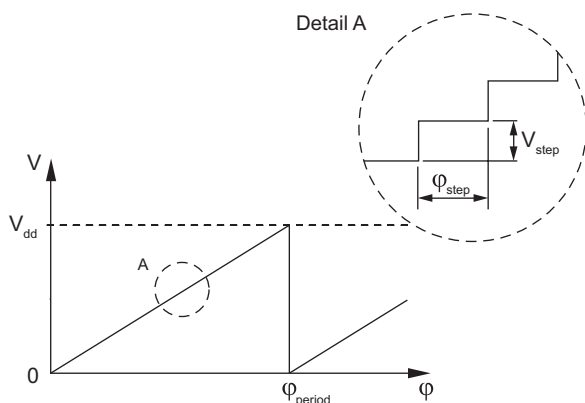

$\varphi_{\text{period}}$	$N_{\text{period}}$	$N_{\text{step}}$	$\varphi_{\text{step}}$
360°	1	1,024	0.35°
180°	2	1,024	0.18°
90°	4	1,024	0.09°
45°	8	512	0.09°

$$\varphi_{\text{step}} = \frac{\varphi_{\text{period}}}{N_{\text{step}}} \quad V_{\text{step}} = \frac{V_{dd}}{N_{\text{step}}}$$

- $\varphi_{\text{period}}$  = Angle covered in one period (one sawtooth)
- $V_{\text{period}}$  = Output voltage range for one period
- $\varphi_{\text{step}}$  = Step angle (angular movement needed to register a change in the position)
- $V_{\text{step}}$  = Output voltage range for one step
- $N_{\text{period}}$  = Number of periods in one revolution
- $N_{\text{step}}$  = Number of steps in one period

### Output type and electrical variant

Rotation / $\varphi_{\text{period}}$	360°	180°	90°	45°
<b>Clockwise</b>	VA	VB	VC	VD
<b>Counterclockwise</b>	VE	VF	VG	VH

# Part numbering

RMF44 IC 08B A 10

## Series

- RMB28** - RMB28 encoder module
- RMF44** - RMB28 encoder module on 44 mm diameter metal flange
- RMF58** - RMB28 encoder module on 58 mm diameter metal flange

## Output type

- AC** - Analogue sinusoidal, 5 V
- DC** - Absolute natural binary BiSS, RS422, 5 V
- IB** - Incremental, open collector, NPN, 24 V
- IC** - Incremental, RS422, 5 V
- IE** - Incremental, open collector, NPN, 5 V
- SC** - Absolute binary synchro-serial (SSI), RS422, 5 V
- SI** - SSI + Incremental, RS422, 5 V

**Vx** - Linear voltage:

Linear voltage output 0 - 5 V, supply 5 V DC				
	360°	180°	90°	45°
CW	VA	VB	VC	VD
CCW	VE	VF	VG	VH

## Resolution

For **AC**:

**01S** - One sine/cosine wave per revolution

For **IA**, **IB**, **IE** and **SI** (counts/positions per revolution):

Decimal			Binary		
2D0 - 2000	D80 - 800	D32 - 320	13B - 8192	10B - 1024	07B - 128
1D6 - 1600	D50 - 500		12B - 4096	09B - 512	
1D0 - 1000	D40 - 400		11B - 2048	08B - 256	

For **IC**, **SC** and **DC** (counts/positions per revolution):

Decimal				Binary		
16D - 16000	4D0 - 4000	1D6 - 1600	D50 - 500	D32 - 320	14B - 16384	11B - 2048
10D - 10000	3D6 - 3600	1D0 - 1000	D40 - 400		13B - 8192	10B - 1024
8D0 - 8000	2D0 - 2000	D80 - 800	D36 - 360		12B - 4096	09B - 512

For **DC** with enabled 12 bit revolution counter:

Binary		
14M - 16384	11M - 2048	08M - 256
13M - 8192	10M - 1024	07M - 128
12M - 4096	09M - 512	

For other resolutions **contact RLS**.

For **Vx**:

**10B** - 1,024 counts/positions per revolution

## Shape

- S** - Square (for RMB28)
- A** - Standard 44 mm or 58 mm flange (for RMF44 and RMF58)

## Special requirements

- 10** - No special requirements (standard)
- 11** - With Molex connector (for **IC**, **SC** and **SI**)
- 12** - With Molex connector (for **SC**, **DC**, **IC**, **Ux\*** and **Wx\***)

Not all combinations are valid. Please refer to the table of available combinations on the next page.

## Table of available combinations

Series	Output type	Resolution	Shape	Special requirements	
RMB28 / RMF44 / RMF58	AC	01S	S / A*	10	
	Vx	10B		10	
	IB	2D0 / 1D6 / 1D0 / D80 / D50 / D40 / D32 / 13B / 12B / 11B / 10B / 09B / 08B / 07B			10
					11
	IC	2D0 / 1D6 / 1D0 / D80 / D50 / D40 / D32 / 13B / 12B / 11B / 10B / 09B / 08B / 07B			10
					11
					12
	IE	2D0 / 1D6 / 1D0 / D80 / D50 / D40 / D32 / 13B / 12B / 11B / 10B / 09B / 08B / 07B			10
					11
	SC	2D0 / 1D6 / 1D0 / D80 / D50 / D40 / D32 / 13B / 12B / 11B / 10B / 09B / 08B / 07B			10
					11
					12
	SI	2D0 / 1D6 / 1D0 / D80 / D50 / D40 / D32 / 13B / 12B / 11B / 10B / 09B / 08B / 07B			10
					11
	DC	2D0 / 1D6 / 1D0 / D80 / D50 / D40 / D32 / 13B / 12B / 11B / 10B / 09B / 08B / 07B / 13M / 12M / 11M / 10M / 09M / 08M / 07M			10
					11
12					
		D36 / 3D6 / 4D0 / 8D0 / 10D / 16D / 14B		10	
		D36 / 3D6 / 4D0 / 8D0 / 10D / 16D / 14B		12	

\* S for RMB28  
A for RMF44 and RMF58

For commutation outputs please refer to [Commutation and incremental magnetic encoder solutions](#).

# Magnetic actuator and magnet ordering information

## Actuator for integration onto shaft

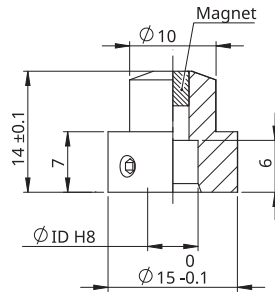
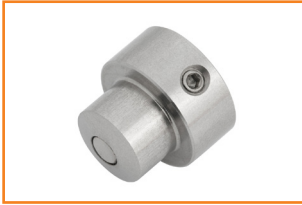

**Shaft** = Ø ID h7  
**Fixing:** Grub screw provided

\* Hole diameter for nominal shaft size.  
See table on the right for more information on available shaft sizes.

**Part numbers:**

For resolutions up to 9 bit absolute (512 cpr incremental)  
**RMA04A2A00** - ID = Ø4 mm      **RMA10A2A00** - ID = Ø10 mm  
**RMA05A2A00** - ID = Ø5 mm      **RMA19A2A00** - ID = Ø3/16" mm  
**RMA06A2A00** - ID = Ø6 mm      **RMA25A2A00** - ID = Ø1/4" mm  
**RMA08A2A00** - ID = Ø8 mm      **RMA37A2A00** - ID = Ø3/8" mm

For resolutions from 10 bit absolute (800 cpr incremental) and above  
**RMA04A3A00** - ID = Ø4 mm      **RMA10A3A00** - ID = Ø10 mm  
**RMA05A3A00** - ID = Ø5 mm      **RMA19A3A00** - ID = Ø3/16" mm  
**RMA06A3A00** - ID = Ø6 mm      **RMA25A3A00** - ID = Ø1/4" mm  
**RMA08A3A00** - ID = Ø8 mm      **RMA37A3A00** - ID = Ø3/8" mm

## Actuator for integration into shaft

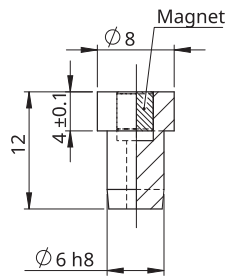

**with N-pole marker**



**Hole** = Ø6G7  
**Fixing:** Adhesive (recommended – LOCTITE 648 or 2701)

**Part numbers:**

For resolutions up to 9 bit absolute (512 cpr incremental)  
**RMH06A2A00**  
 For resolutions from 10 bit absolute (800 cpr incremental) and above  
**RMH06A3A00**

**With N-pole marker scribed to a ±5° accuracy:**

For resolutions up to 9 bit absolute (512 cpr incremental)  
**RMH06A2A02**  
 For resolutions from 10 bit absolute (800 cpr incremental) and above  
**RMH06A3A02**

## Magnet for direct recessing in non-ferrous shafts

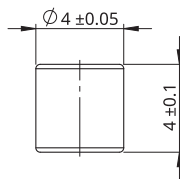

**Fixing:** Adhesive (recommended – LOCTITE 648 or 2701)

**Part numbers:**

For resolutions up to 9 bit absolute (512 cpr incremental)  
**RMM44A2A00** (individually packed) – for sample quantities only  
**RMM44A2C00** (packed in tubes)  
 For resolutions from 10 bit absolute (800 cpr incremental) and above  
**RMM44A3A00** (individually packed) – for sample quantities only  
**RMM44A3C00** (packed in tubes)

## Head office

---

### RLS Merilna tehnika d.o.o.

Poslovna cona Žeje pri Komendi  
Pod vrbami 2  
SI-1218 Komenda  
Slovenia

T +386 1 5272100  
E [mail@rls.si](mailto:mail@rls.si)  
[www.rls.si](http://www.rls.si)

## Global support

---

Visit our [website](#) to contact your nearest sales representative.

## Document issues

---

Issue	Date	Page	Description
1	29. 11. 2024	General	Redesign of RMB28D01

This product is not designed or intended for use outside the environmental limitations and operating parameters expressly stated on the product's datasheet. Products are not designed or intended for use in medical, military, aerospace, automotive or oil & gas applications or any safety-critical applications where a failure of the product could cause severe environmental or property damage, personal injury or death. Any use in such applications must be specifically agreed to by seller in writing, and is subject to such additional terms as the seller may impose in its sole discretion. Use of products in such applications is at buyer's own risk, and buyer will indemnify and hold harmless seller and its affiliates against any liability, loss, damage or expense arising from such use. Information contained in this datasheet was derived from product testing under controlled laboratory conditions and data reported thereon is subject to the stated tolerances and variations, or if none are stated, then to tolerances and variations consistent with usual trade practices and testing methods. The product's performance outside of laboratory conditions, including when one or more operating parameters is at its maximum range, may not conform to the product's datasheet. Further, information in the product's datasheet does not reflect the performance of the product in any application, end-use or operating environment buyer or its customer may put the product to. Seller and its affiliates make no recommendation, warranty or representation as to the suitability of the product for buyer's application, use, end-product, process or combination with any other product or as to any results buyer or its customer might obtain in their use of the product. Buyer should use its own knowledge, judgment, expertise and testing in selecting the product for buyer's application, end-use and/or operating environment, and should not rely on any oral or written statement, representation, or samples made by seller or its affiliates for any purpose. EXCEPT FOR THE WARRANTIES EXPRESSLY SET FORTH IN THE SELLER'S TERMS AND CONDITIONS OF SALE, SELLER MAKES NO WARRANTY EXPRESS OR IMPLIED WITH RESPECT TO THE PRODUCT, INCLUDING ANY WARRANTY OF MERCHANTABILITY OR FITNESS FOR ANY PARTICULAR PURPOSE, WHICH ARE DISCLAIMED AND EXCLUDED. All sales are subject to seller's exclusive terms and conditions of sale which, where the seller is (a) RLS Merilna tehnika d. o. o., are available at <https://www.rls.si/eng/salesterms>, (b) Renishaw, Inc., are available at <https://www.renishaw.com/legal/en/-42186>, or (c) another person, are available on request, and in each case, are incorporated herein by reference, and are the exclusive terms of sale. No other terms and conditions apply. Buyer is not authorized to make any statements or representations that expand upon or extend the environmental limitations and operating parameters of the products, or which imply permitted usage outside of that expressly stated on the datasheet or agreed to in writing by seller.

RLS Merilna tehnika d. o. o. has made considerable effort to ensure the content of this document is correct at the date of publication but makes no warranties or representations regarding the content. RLS Merilna tehnika d. o. o. excludes liability, howsoever arising, for any inaccuracies in this document. © 2024 RLS d. o. o.