

RLC2HD miniature PCB level incremental magnetic encoder sensor system

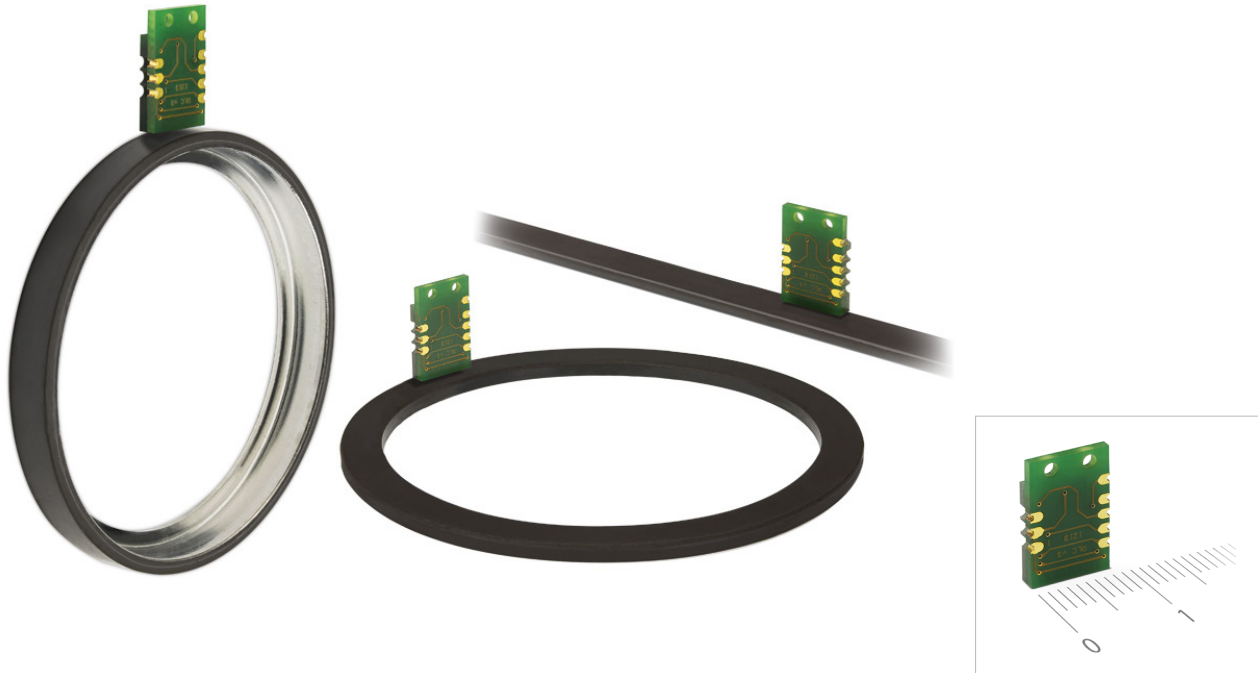

RLC2HD is a PCB level incremental encoder sensor system consisting of a PCB sensor and a magnetic scale or a ring. It has been designed for embedded motion control applications as a position control loop feedback element in space constraint applications.

The information carrier is a periodically magnetised scale with a pole length of 2 mm. Radial or axial reading of the ring is possible.

State of the art position sensing assures highly repeatable position measurement under wide installation tolerances and temperature ranges.

Position information is output in incremental quadrature format with the option of a periodic reference mark (every pole).

Maximum speed depends on the chosen resolution and minimum edge separation time; eg. for linear applications to 7 m/s at 1 μ m and to 75 m/s at 10 μ m. For more information about maximum speed in rotary applications go to [magnetic ring data sheet](#).

The RLC2HD is a moisture sensitive device. It should be soldered immediately after the transportation packaging has been opened. If not, baking procedure should be performed.

- Miniature design; 2 × 8 × 12 mm
- Incremental quadrature TTL output signals A, B, Z
- Periodic, bidirectional index impulse
- High speed operation
- RoHS compliant- see Declaration of conformity

Storage and handling for linear magnetic scales

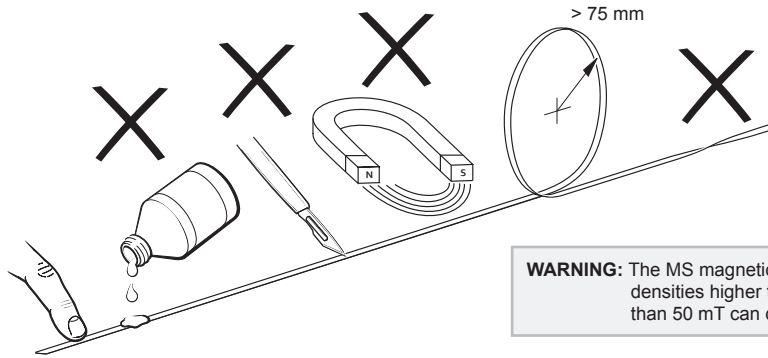

WARNING: The MS magnetic scale should not be exposed to magnetic field densities higher than 50 mT on its surface. Magnetic fields higher than 50 mT can damage the scale.

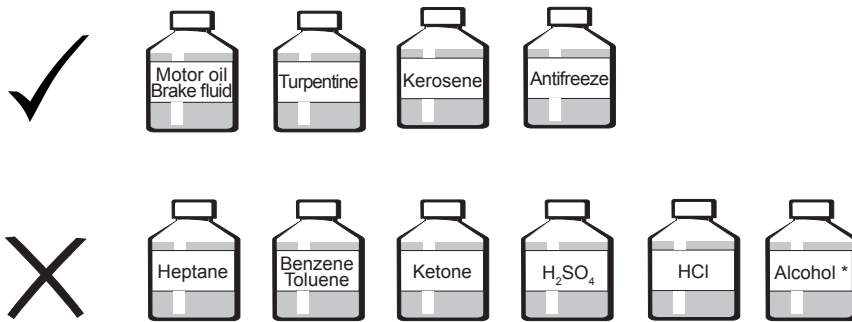

* Use of alcohol for cleaning is considered safe, however, it is not allowed to immerse the scale in alcohol.

For radial and axial ring storage and handling refer to [magnetic ring data sheet](#).

Dimensions

Dimensions and tolerances are in mm.

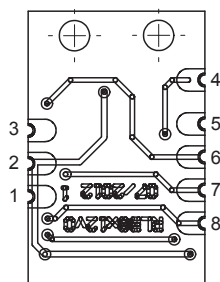
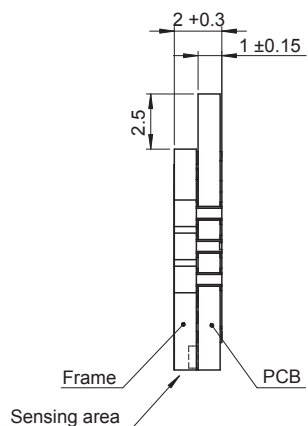
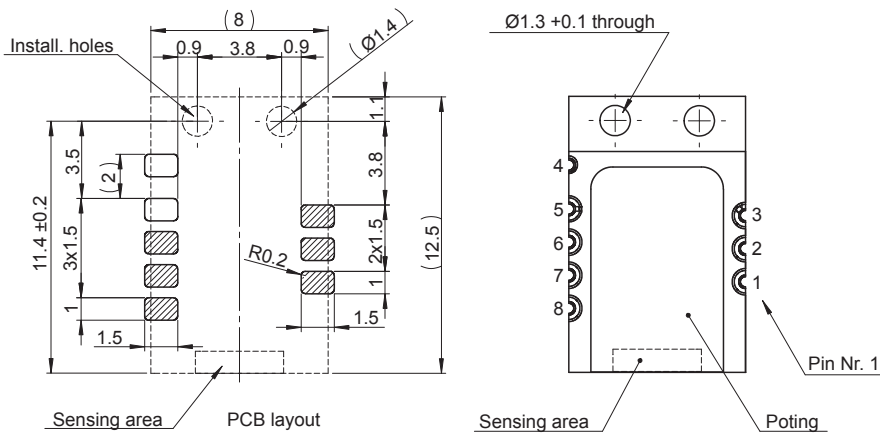

Connections

Pin	Signal
1	Vdd (+5 V)
2	Vdd (+5 V)
3	GND (0 V)
4	NC
5	NC
6	Z
7	B
8	A

Installation tolerances

Dimensions and tolerances are in mm.

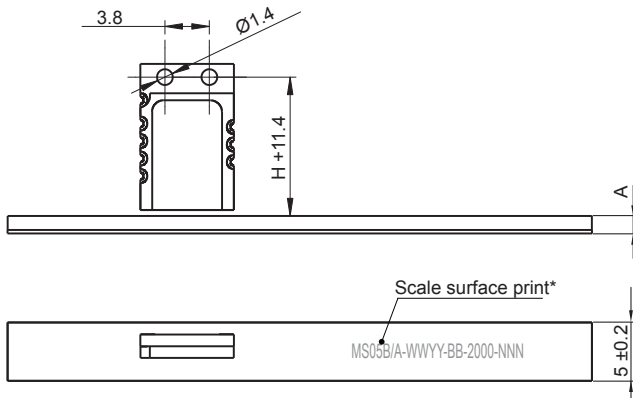

	Magnetic scale thickness (A)	Ride height (H)
With back-adhesion tape (option A)	1.5 ± 0.15	0.1–0.8
With back-adhesion tape, with cover foil (option B)	1.6 ± 0.15	0.1–0.7
No back-adhesion tape (option I)	1.3 ± 0.15	0.1–0.8
No back-adhesion tape, with cover foil (option N)	1.4 ± 0.15	0.1–0.7

* Scale surface print does not represent the actual part numbering. It is used for orientation purpose of the scale vs. readhead and contains information which allows the traceability of the scale to production data.

Ride height

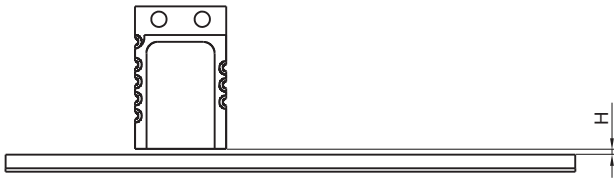

Lateral offset

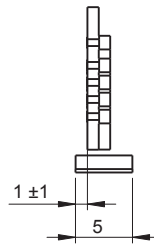

Pitch

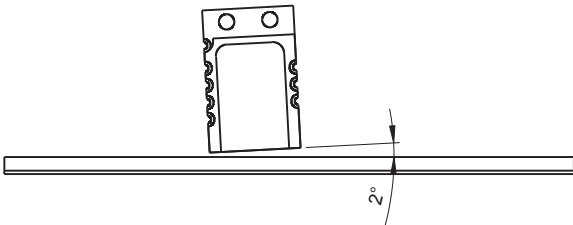

Roll

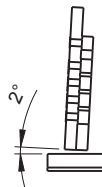

Yaw

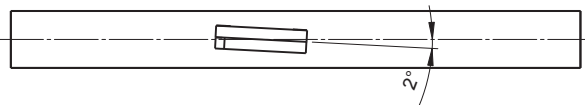

For radial and axial ring installation tolerances refer to [magnetic ring data sheet](#).

Technical specifications

System data											
Maximum length for MS scale	50 m										
Pole length	2 mm										
For rotary maximum speed table refer to magnetic ring data sheet . Available resolutions and maximum speed for linear application:											
Part numbering	Resolution (µm)	Counts / 2 mm	Maximum speed (m/s)								
13B	≈ 0.244	8,192	1.82	0.91	0.23	0.11	0.06	0.03	0.02	0.01	0.01
12B	≈ 0.488	4,096	3.65	1.82	0.46	0.23	0.12	0.06	0.05	0.02	0.01
11B	≈ 0.976	2,048	7.30	3.65	0.91	0.46	0.24	0.12	0.10	0.05	0.02
2D0	1	2,000	7.47	3.73	0.93	0.47	0.24	0.12	0.10	0.05	0.02
1D6	1.25	1,600	9.33	4.67	1.17	0.58	0.30	0.16	0.12	0.06	0.03
10B	≈ 1.953	1,024	14.58	7.30	1.82	0.91	0.48	0.24	0.19	0.10	0.05
1D0	2	1,000	14.93	7.47	1.87	0.93	0.49	0.25	0.20	0.10	0.05
D80	2.5	800	18.67	9.33	2.34	1.17	0.61	0.31	0.25	0.12	0.06
09B	≈ 3.906	512	29.17	14.58	3.65	1.82	0.95	0.49	0.38	0.19	0.10
D50	4	500	29.87	14.93	3.73	1.87	0.97	0.50	0.39	0.20	0.10
D40	5	400	37.33	18.67	4.67	2.34	1.22	0.62	0.49	0.25	0.12
D32	6.25	320	46.67	23.33	5.84	2.91	1.52	0.78	0.61	0.31	0.16
08B	≈ 7.812	256	58.34	29.17	7.30	3.65	1.90	0.97	0.77	0.39	0.19
D20	10	200	74.67	37.33	9.33	4.67	2.43	1.24	0.98	0.50	0.25
D16	12.5	160	46.67	23.33	5.84	2.91	1.52	0.78	0.61	0.31	0.16
07B	15.625	128	80.00	58.34	14.58	7.30	3.81	1.94	1.53	0.77	0.39
D10	20	100	74.67	37.33	9.33	4.67	2.43	1.24	0.98	0.50	0.25
D08	25	80	46.67	23.33	5.84	2.91	1.52	0.78	0.61	0.31	0.16
06B	31.25	64	80.00	80.00	29.17	14.58	7.62	3.89	3.07	1.55	0.78
D04	50	40	46.67	23.33	5.84	2.91	1.52	0.78	0.61	0.31	0.16
05B	62.5	32	80.00	80.00	58.34	29.17	15.22	7.78	6.14	3.10	1.56
04B	125	16	n/a	80.00	80.00	58.34	30.43	15.56	12.28	6.19	3.11
03B	250	8	n/a	n/a	80.00	80.00	60.86	31.11	24.56	12.39	6.23
Minimum edge separation (µs)			0.07	0.12	0.50	1	2	4	5	10	20
Maximum count frequency (MHz)			15	8	2	1	0.5	0.25	0.2	0.1	0.05
Part numbering			K	A	B	C	D	E	F	G	H
Accuracy grade for MS scales	±40 µm/m										
Repeatability	Better than unit of resolution for movement in the same direction										
Hysteresis	< 2 µm up to 0.2 mm ride height										
Mechanical data											
Mass	RLC readhead 1.25 g;; magnetic scale MS05 30 g/m; for radial and axial rings refer to magnetic ring data sheet										
Environmental conditions											
Temperature	Operating -30 °C to +85 °C Storage -40 °C to +85 °C										
Vibrations (55 Hz to 2000 Hz)	300 m/s ² (IEC 60068-2-6)										
Shocks (11 ms)	300 m/s ² (IEC 60068-2-27)										
Moisture level	MSL6 (IPC/JEDEC-J-STD-020)										
Baking procedure	48 h/125 °C or according to IPC/JEDEC-J_STD_033										

RLC2HD – Incremental, no line driver

Power supply	5 V \pm 0.25 V – voltage on readhead
Power consumption	< 20 mA
Output signals	Digital – TTL-level (A, B, Z)
Saturation voltage hi (I = -4 mA)	$V_{dd} - 0.4$ V
Saturation voltage lo (I = 4 mA)	0.4 V
Rise and fall time ($c_c = 50$ pF)	60 ns
ESD susceptibility of all pins	2 kV (HBM 100 pF, discharge through 1.5 k Ω)

Timing diagram – Incremental, periodic reference mark

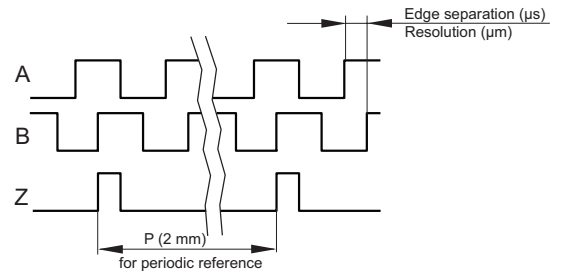

Reference mark

Periodic reference mark, every 2 mm (as per scale pitch). The RLC2HD readhead should be ordered with reference mark option C. Magnetic scale or ring should be ordered with **no** reference mark. Position information is output in incremental quadrature format with periodic reference signals. Reference periods correspond to pole length of magnetisation.

Readhead part numbering



RLC2HD system

RLC2HD readhead
eg. RLC2HDA13BA00C00

Magnetic scale / ring
eg. MS05BM100A0000 for scale /
MR047B040B076B00 for ring

RLC 2 HD A 13B A 00 C 00

Pole length
2 - 2 mm pole length

Output type
HD - Incremental, no line driver

Interpolation factor

13B - 8192 (0.244 μm)	09B - 512	D10 - 100 (20 μm)
12B - 4096 (0.488 μm)	D50 - 500 (4 μm)	D08 - 80 (25 μm)
11B - 2048	D40 - 400 (5 μm)	06B - 64
2D0 - 2000 (1 μm)	D32 - 320	D04 - 40 (50 μm)
1D6 - 1600	08B - 256	05B - 32
10B - 1024	D20 - 200 (10 μm)	04B - 16 (125 μm)
1D0 - 1000 (2 μm)	D16 - 160	03B - 8 (250 μm)
D80 - 800	07B - 128	

Special requirements
00 - No special requirements (standard)
07 - Tape and reel packaging (for large quantities - see page 8)
Reference
C - Periodic as per scale pitch (2 mm)

Connections
00 - No connector

Minimum edge separation (Frequency)

K - 0.07 μs (15 MHz) *
A - 0.12 μs (8 MHz) **
B - 0.5 μs (2 MHz)
C - 1 μs (1 MHz)
D - 2 μs (0.5 MHz)
E - 4 μs (0.25 MHz)
F - 5 μs (0.2 MHz)
G - 10 μs (0.1 MHz)
H - 20 μs (0.05 MHz)

* Not available for interpolation factors **03B** and **04B** interpolation.
 ** Not available for interpolation factor **03B**.

Formula for linear application resolution

$$\text{Resolution } (\mu\text{m}) = \frac{2000}{\text{Interpolation}}$$

Formula for rotary application resolution

$$\text{Resolution (ppr)} = \frac{\text{cpr}}{4}$$

$$\text{Resolution (cpr)} = \text{Pole number} \times \text{Interpolation}$$

For radial and axial ring part numbering refer to [magnetic ring data sheet](#).

Series	Output type	N/A	Interpolation factor	Minimum edge separation	FFC Connections	Reference	Special Requirements
RLC2	HD	A	05B / D04 / 06B / D08 / D10 / 07B / D16 / D20 / 08B / D32 / D40 / D50 / 09B / D80 / 1D0 / 10B / 1D6 / 2D0 / 11B / 12B / 13B	K / A / B / C / D / E / F / G / H	00	C	00 / 07
			04B	A / B / C / D / E / F / G / H			
			03B	B / C / D / E / F / G / H			

Magnetic scale part numbering

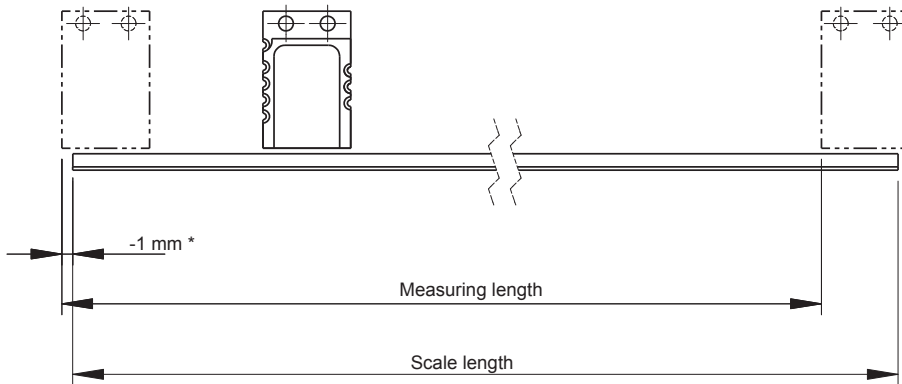

* Beginning of measuring length from elastoferrite layer edge (B) = -1 mm
 Measuring length (C) = SL - 10 mm

MS05 B M100 A 0000

Accuracy grade
 B - $\pm 40 \mu\text{m/m}$

Scale length
 xxxx - Where xxxx equals scale length in cm
 Mxxx - Where xxx equals scale length in mm
 (for scale lengths below 1 m)

Position of reference mark
 0000 - No reference mark

Options
 A - VHB back-adhesive tape (standard)
 B - VHB back-adhesive tape, with cover foil*
 I - No back-adhesive tape
 N - No back-adhesive tape, with cover foil*

* Cover foil supplied separately.

Cover foil part numbering

CF05 1000

Width of cover foil
 CF05 - Width 5 mm

Foil length
 xxxx - Where xxxx equals foil length in cm (eg. 0400 equals 400 cm of foil)

For radial and axial ring part numbering refer to [magnetic ring data sheet](#).

Tape and reel packaging - special option 07

W24/P12/T0.3 in 13" reel

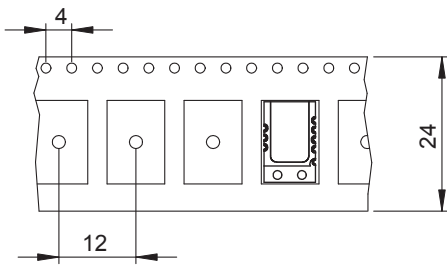

Accessories part numbering



USB encoder interface
E201



Magnet viewer
MM0001

Head office

RLS merilna tehnika d.o.o.

Poslovna cona Žeje pri Komendi
Pod vrbami 2
SI-1218 Komenda
Slovenia

T +386 1 5272100

F +386 1 5272129

E mail@rls.si

www.rls.si

Document issues

Issue	Date	Page	Corrections made
1	22. 12. 2014	-	New document
2	14. 1. 2015	5	76 pole ring resolutions corrected
3	18. 9. 2017	1	Ring reference and RoHS added
		2	Storage added and Dimensions amended
		4	Technical specifications amended
		5	Output description added
		6, 7, 8	Readhead, magnetic scale and accessories part numbering amended

This product is not designed or intended for use outside the environmental limitations and operating parameters expressly stated on the product's datasheet. Products are not designed or intended for use in medical, military, aerospace, automotive or oil & gas applications or any safety-critical applications where a failure of the product could cause severe environmental or property damage, personal injury or death. Any use in such applications must be specifically agreed to by seller in writing, and is subject to such additional terms as the seller may impose in its sole discretion. Use of products in such applications is at buyer's own risk, and buyer will indemnify and hold harmless seller and its affiliates against any liability, loss, damage or expense arising from such use. Information contained in this datasheet was derived from product testing under controlled laboratory conditions and data reported thereon is subject to the stated tolerances and variations, or if none are stated, then to tolerances and variations consistent with usual trade practices and testing methods. The product's performance outside of laboratory conditions, including when one or more operating parameters is at its maximum range, may not conform to the product's datasheet. Further, information in the product's datasheet does not reflect the performance of the product in any application, end-use or operating environment buyer or its customer may put the product to. Seller and its affiliates make no recommendation, warranty or representation as to the suitability of the product for buyer's application, use, end-product, process or combination with any other product or as to any results buyer or its customer might obtain in their use of the product. Buyer should use its own knowledge, judgment, expertise and testing in selecting the product for buyer's application, end-use and/or operating environment, and should not rely on any oral or written statement, representation, or samples made by seller or its affiliates for any purpose. EXCEPT FOR THE WARRANTIES EXPRESSLY SET FORTH IN THE SELLER'S TERMS AND CONDITIONS OF SALE, SELLER MAKES NO WARRANTY EXPRESS OR IMPLIED WITH RESPECT TO THE PRODUCT, INCLUDING ANY WARRANTY OF MERCHANTABILITY OR FITNESS FOR ANY PARTICULAR PURPOSE, WHICH ARE DISCLAIMED AND EXCLUDED. All sales are subject to seller's exclusive terms and conditions of sale which, where the seller is (a) RLS merilna tehnika d.o.o., are available at <https://www.rls.si/customer-service>, (b) Renishaw, Inc., are available at <http://www.renishaw.com/Shop/legal/en/-42186>, or (c) another person, are available on request, and in each case, are incorporated herein by reference, and are the exclusive terms of sale. No other terms and conditions apply. Buyer is not authorized to make any statements or representations that expand upon or extend the environmental limitations and operating parameters of the products, or which imply permitted usage outside of that expressly stated on the datasheet or agreed to in writing by seller.

RLS merilna tehnika d.o.o. has made considerable effort to ensure the content of this document is correct at the date of publication but makes no warranties or representations regarding the content. RLS merilna tehnika d.o.o. excludes liability, howsoever arising, for any inaccuracies in this document. © 2018 RLS d.o.o.