

Artos™

Board Level Rotary and Linear Absolute Magnetic Encoder System

TRUE
ABSOLUTE
SYSTEM

PARALLEL
OUTPUTS
ABSOLUTE +
ABZ

HIGH
SPEED AND
RESOLUTION

Artos™ is an absolute magnetic encoder system designed for motion control applications as a feedback element for angle and velocity control loops.

A highly reliable measurement principle and processing ensure low position latency, high resolution and high angular velocity. The compact PCB-A design and low weight of the encoder system make it suitable for applications with limited space in relatively clean environments.



Features and benefits

- ▶ True absolute system
- ▶ High accuracy and resolution
- ▶ Suitable for highly dynamic control loops
- ▶ SSI and BiSS C communicational protocols + parallel ABZ channel
- ▶ Speeds up to 30,000 rpm for rotary and 20 m/s for linear applications
- ▶ Compatible with rings and linear/partial arc scales
- ▶ Wide installation tolerances
- ▶ Compact design with horizontal or vertical connector



SMT PICK AND PLACE



GIMBALS



LINEAR MOTOR



MEDICAL



ASSEMBLY LINES

General information

Artos™ provides a true-absolute position information immediately after power-on via the selected communication protocol. The encoder system is extremely reliable due to the large installation tolerances (axial/radial/tangential offset) and the built-in robust algorithms for position calculation and error detection.







The measuring principle is based on a magnetic ring/scale magnetised with the incremental and absolute track with a pseudo-random binary sequence (PRBS) read by the RLS proprietary sensor technology. Once installed, the encoder system does not need to be calibrated. To ensure the installation is correct, the operator can observe the setup LED while rotating the magnetic ring/scale in either direction.

The magnetic ring is available in two versions: exposed and protected with a cover foil. The version with the visible elasto-ferrite layer, called the exposed ring, is intended for applications where aggressive liquids are not expected to damage the sensitive part of the ring. The exposed ring can withstand dust, moisture and dirt. If, on the other hand, a thin layer of stainless steel is applied over the elasto-ferrite layer, the ring becomes more robust and suitable for harsh environments. The cover foil can be applied in two different ways. In one variant, the cover foil is wrapped around the circumference of the ring, with the elasto-ferrite layer of the ring visible from the sides. This type of protection is suitable for high rotational speeds and protects the sensitive elasto-ferrite layer from rotational forces. In the second variant, the cover foil is applied and welded around the entire circumference. This type of protection gives the ring IP67 protection and can withstand significantly higher rotational speeds. The fully protected ring is used in combination with the sealed readhead due to the demanding environmental conditions. Further information on the sealed readhead can be found in data sheet [DRD01](#).

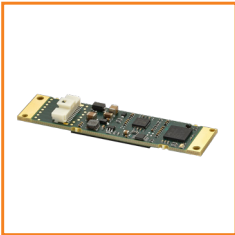
The magnetic rings are available in different sizes, from 57 mm to 478 mm outer diameter. In addition, the readhead is compatible with a linear flexible absolute scale of up to 32 m in length, which can also be used for partial arc applications from the smallest diameter of 200 mm upwards. For linear and partial arc applications, the flexible magnetic scale DS19 is used. The use of the DS19 magnetic scale does not support a full 360° rotation of the shaft, but is intended for applications with large shafts where a full rotation is not required.

Choose your Artos system

The PCB readhead is compatible with solid rings, solid scales and the flexible linear/partial arc scales DS19. The SAS19 scale, offered in exposed and welded (IP67-rated) versions, provides higher accuracy of $\pm 6 \mu\text{m/m}$.

Artos™ PCB-A readhead 	+	Exposed SAR radial ring 	SAR ring with cover foil 	SAR ring with welded cover foil 
		Partial arc scale DS19 	Linear scale DS19 	SAS19 exposed scale 

Further information on compatible rings and scales can be found in [SARD01](#) and [ASD01](#), available at [RLS Media center](#).

Storage and handling

Storage temperature



-40 °C to +85 °C

Operating temperature



-40 °C to +85 °C

Humidity



Up to 70 % non-condensing

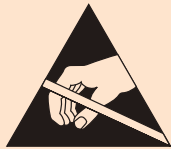
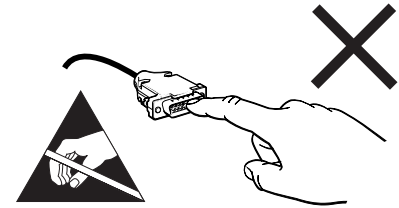
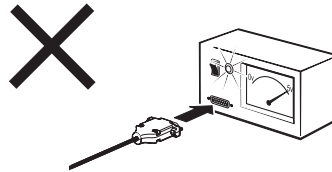
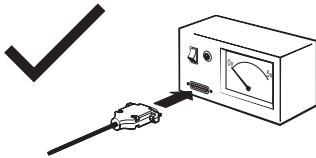

Readhead is ESD sensitive - handle with care.

Do not touch electronic circuit, wires or sensor area without proper ESD protection or outside of ESD controlled environment.

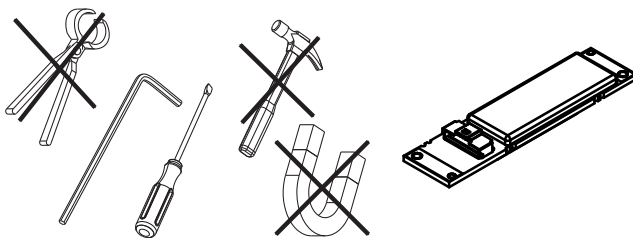

The PCB-A readhead is a mechanically sensitive component. Hold it by the edges, touch it only lightly, minimize pressure and avoid bending it while holding it securely to prevent it from falling. Ensure maximum cleanliness. When not in use, place it in ESD protective packaging (box or tray).

Packaging

Less than 20 readheads are packed individually in antistatic boxes. From a quantity of 21 pieces or more, the readheads are packed in antistatic trays (see table below). The trays are packed together in a cardboard box (8 trays per box).

Part	Tray size	Box size
Artos™ readhead	15 units per tray	8 trays per box

Labeling/Engraving

The engraving on the PCB-A readhead contains a QR code with a serial number.

Dimensions drawing

Dimensions and tolerances are in mm. Dimensions without tolerance values are in accordance with ISO 2768-m.



Board with vertical connector

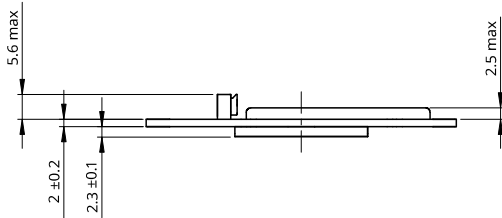

Board with horizontal connector

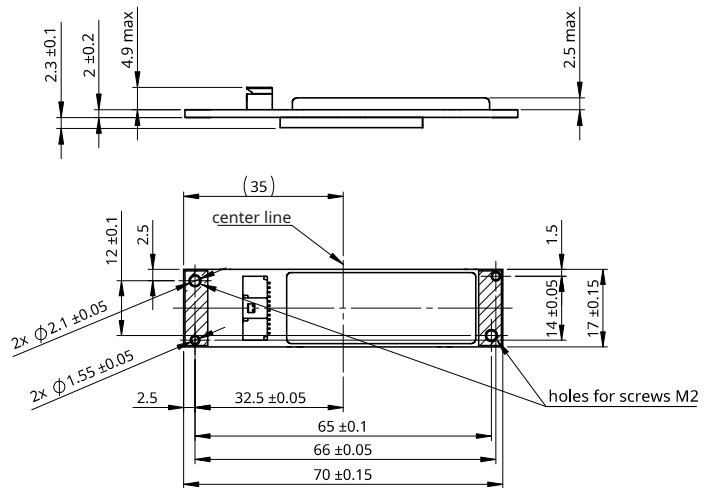

General tolerances for linear dimensions according to ISO 2768-m

Tolerance class	up to 6	6-30	30-120
m (medium)	±0.1	±0.2	±0.3

Top side

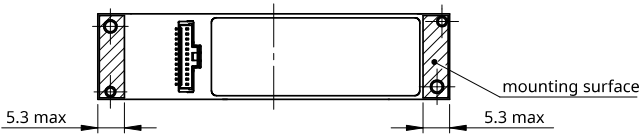

Bottom side

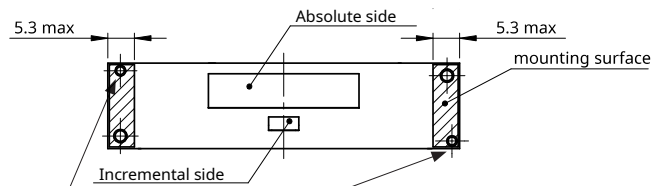

Positioning holes on both sides of the board for poka-yoke installation

3D model available for download at [RLS website](#).

Further information on compatible rings and scales can be found in [SARD01](#) and [ASD01](#), available at [RLS Media center](#).

Installation instructions

The readhead can be installed in 2 different ways - from below or from above. Carefully plan the orientation of the readhead and the ring/magnetic scale. The engraving on the ring and the imprint on the scale can be used to determine the orientation.

We recommend the use of M2 fasteners with washers. For more information, please refer to the [Table of recommended fastener tightening torques](#).

After mounting the ring or magnetic scale with the readhead, make sure that the distance between them corresponds exactly to the installation dimensions and tolerances specified in data sheets [SARD01](#) and [ASD01](#). A simple plastic shim can be used to align the air gap, but this cannot align the readhead in all important directions (tangential, axial, yaw, pitch and roll offsets). It is recommended to set the air gap to the optimum value. Please check the optimal ride height for each ring size in the [SARD01](#) or for the linear/partial arc scale DS19 in the [ASD01](#) data sheet. Make sure that the readhead, shim and ring or magnetic scale are fully aligned. As soon as the screws holding the readhead are tightened, the spacer can be removed.

The LED on the readhead must light up green at all measuring positions, otherwise the installation has not been performed correctly. Further information on the LED can be found in the [Status indicator LED](#) chapter.

Improper mounting of the magnetic ring/scale and the readhead can impair the performance or function of the magnetic encoder system and lead to total failure.

Installation from above

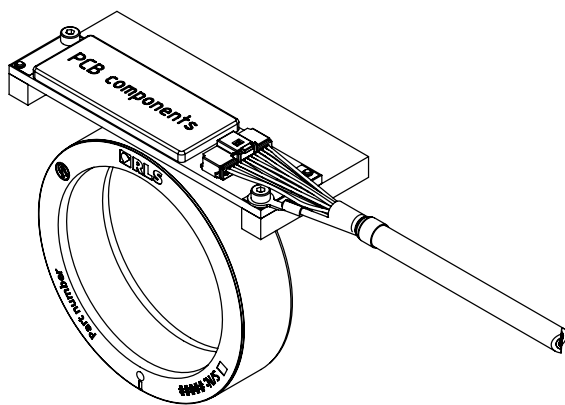

Installation from below

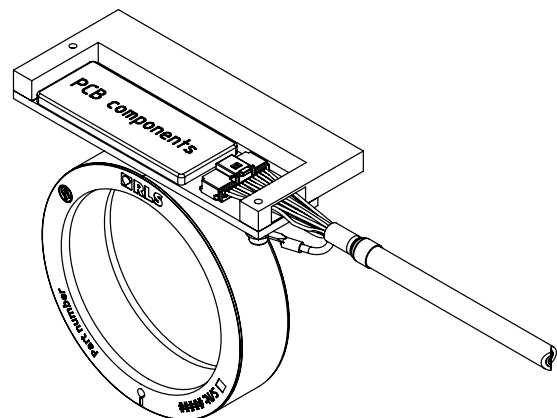

To avoid damaging the PCB, do not use countersunk fasteners.

Ensure metal surfaces are anodized and maintain a minimum distance of 0.5 mm from sensitive components.

The magnetic encoder system must be used in accordance with the specified degree of protection. The following factors must be taken into account: IP protection class, operating temperature, external magnetic field, mechanical load and EMC compatibility.

The magnetic encoder system is sensitive to external magnetic fields. The extent to which the magnetic encoder system is affected depends on the magnitude and direction of the external magnetic field. In particular, the rapidly changing stray magnetic fields affect the system and can change its function. Field strengths of more than 1 mT can cause the system to malfunction, resulting in the readhead reporting an invalid position despite inactive error and warning bits in the detailed status and a green LED. Magnetic field strengths of more than 25 mT lead to irreversible damage to the magnetic ring or scale and must be replaced.

Further information and useful tips on the installation of the ring and the partial arc magnetic scale on the shaft, can be found in data sheets [SARD01](#) and [ASD01](#).

Technical specifications

System specifications

Type of absolute measurement	Pseudo-random binary sequence (PRBS) absolute code; RLS proprietary sensor technology
Reading type	Radial
Hysteresis	<3.5 µm at nominal ride height SAR057 = 25 arcsec SAR081 = 18 arcsec SAR114 = 13 arcsec SAR162 = 9 arcsec SAR229 = 6 arcsec SAR325 = 4 arcsec SAR478 = 3 arcsec
Unidirectional repeatability	<1.5 µm
Resolution	Rings: up to 23 bits binary resolution (depends on the ring size) Magnetic scales: up to ~0.100 µm See Table of available resolutions.
Sensor and processing latency	11 µs
Internal loop refresh rate	91 kHz
Maximum speed during power up	Rotary: 500 rpm Linear: 10 m/s

Electrical data

Power supply	From 4.75 V to 30 V (voltage on readhead, consider voltage drop over cable)
Reverse polarity protection	Yes
Set-up time after switch-on	<200 ms
Power consumption (without load)	0.7 W
Communication standard	Differential line driver signal (RS422)
Output load	±40 mA
ESD protection	HBM, max. ±2 kV
Maximum cable length	10 m

Mechanical data

Mass	9 g
Conformal coating (optional)	AB chimie 746 E UV LED (low viscosity)
Connector type	Vertical: MOLEX 501331-1207 Horizontal: MOLEX 501568-1207
Possible connector mating part	Receptacle Housing: Molex 501330-1200 Female Crimp Terminals: 501193-7000 501193-8000 501193-9000 501334-0000

Environmental data

Operating and storage temperature	-40 °C to +85 °C
Vibrations (55 Hz to 2000 Hz)	30 g m/s ² (IEC 60068-2-6)
Shocks (11 ms)	100 g (IEC 60068-2-27)
Humidity	70 % (non-condensing)
ESD protection	HBM, Class 2, ±2 kV (valid only on RS422 signals on connector; do not touch other components)
Maximum external magnetic field during operation	1 mT

Electrical connections

Vertical connector



Pin 1

Horizontal connector



Pin 1

Function	Pin	Signal (BiSS C / SSI) + ABZ
Incremental output (AB channel)	1	Z-
	2	Z+
	3	B-
	4	B+
	5	A-
	6	A+
Power supply	7	GND
	8	Vin
Serial communication (Absolute output)	9	SLO- (data)
	10	SLO+ (data)
	11	MA- (clock)
	12	MA+ (clock)

If conformal coating is applied, the output connector is not protected by the coating.

System integration / Shield connection

The mounting surfaces of the PCB are not connected to signal ground. To achieve EMC compliance, the encoder system must be correctly integrated. Particular attention must be paid to the shielding arrangements. The mounting surfaces of the encoder and the cable shield must be connected to chassis with a good and reliable connection. Preferably, the cable shield is crimped on a ring terminal, which is bolted through one of the mounting holes of the encoder. Special care must be taken to ensure that the cable shield only touches the gold mounting surface. See the **Installation instructions**.

Status indicator LED

Once the ring or magnetic scale has been installed, the readhead can be easily mounted on the machine using the LED setup indicator. The LED indicator shows the internal status of the encoder and is used to facilitate the installation and diagnosis of the encoder system. According to the table [Detailed status description](#), certain errors are latched, resulting in LED indicating error status persistently. To clear latched error statuses, communication with readhead or readhead power cycle is required.

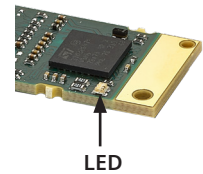

Slow flashing of LED indicates that the encoder is receiving power, but communication between the encoder and the controller has not yet been established. The error status has a higher priority than the warning status in the LED signaling. The signaling of LED may differ from the encoder status signaled by the controller. In case of error or warning the LED remains red/orange for at least 200 ms.

LED Status	Status	Description
● Green	Normal operation	Position data is valid.
● Orange	Warning	<ul style="list-style-type: none"> The internal temperature is near operational limits. The encoder system is near operational limits. For details please check possible causes under the Error status.
● Red	Error	Position data is not valid. Possible causes: <ul style="list-style-type: none"> The distance between the readhead and the magnetic scale is too large. The readhead is out of alignment with the ring or magnetic scale or they are demagnetised. Incorrect orientation of the readhead and ring or magnetic scale. The encoder speed is out of operational limits.
●●●●● Fast red flashing	Error	Position data is not valid. Internal system error.
●●● Slow red, green or orange flashing	/	The communication has not been established.
●●● Irregular flashing	/	Power supply too low.
○ No light	/	No power supply.

The LED signal statuses listed in the table above do not indicate non-optimal installation of the readhead, e. g. an accuracy outside the specified range.

During installation it is advised that the ring or scale reciprocate over the entire range of motion to observe the encoder status on the LED (max speed is 5 rpm for rotary or 50 mm/s for linear applications). As soon as the LED indicator remains green over the entire range of motion, this indicates that the encoder is correctly installed.

Troubleshooting

If the readhead reports an error during operation due to incorrect decoding of the absolute position on the magnetic ring/scale, this indicates a serious problem. Serious problems include incorrect installation or a damaged magnetic pattern on the ring or scale. To determine the cause of the problem, please proceed as follows:

- Make sure that the part number on the readhead and the ring or scale match the required combination. The valid combination of ring and readhead can be verified with the first 6 letters of the part number.
- Verify that the installation matches the specification of the encoder for the orientation of the readhead relative to the ring/scale (ride height/radial offset, lateral/axial offset, centerline/ tangential, roll, pitch and yaw offsets).
- If possible, check the error location on the magnetic ring/scale with the magnetic viewer for an abnormal pattern in the magnetic code.
- Check the power supply. This is especially important for longer cable lengths. Take into account the voltage drop over the cable. Check the [Minimum input voltage vs. cable length](#).
- Refer to [Maximum speed calculator for rings](#) or [Maximum speed calculator for scales](#) to ensure that the required rotational/linear speed matches the selected parameters of the readhead (resolution and minimum edge separation values) and ring dimension. This is important if the ABZ channel is enabled in parallel to the BiSS/SSI absolute channel.

BiSS C Communication interface

The absolute position data and the status are available via the BiSS C protocol. The length of the position data varies depending on the combination of SAR ring, linear/partial arc scale and selected resolution. In combination with the SAR ring, the length of the position data is up to 23 bits. In combination with the scale, the length of the position data is up to 29 bits. The position data is always right-aligned, MSB first and without padding bits. The absolute position is followed by 2 general status bits, which are active low (error and warning) and 6 bits CRC (inverted).

BiSS is implemented for point-to-point operation, multiple slaves are not supported. The communication is unidirectional.

Electrical connection

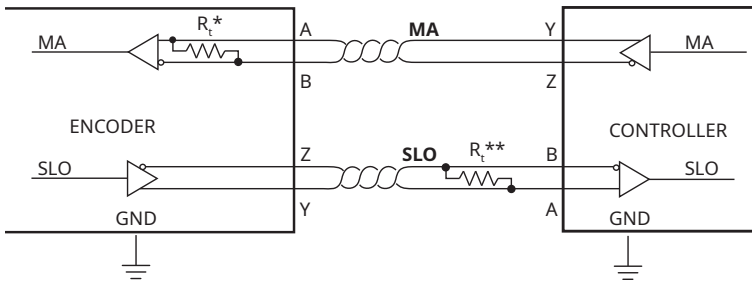

Signals

MA	Master clock.
SLO	Slave out. Data is output on rising edge on MA.

* The MA and SLO lines are 5 V RS422 compatible differential pairs. The termination resistor on the MA line is integrated inside the encoder.

** Termination at the controller is required, if total cable length is longer than 5 m. The nominal impedance of the cable is 120 Ω.

BiSS C timing diagram

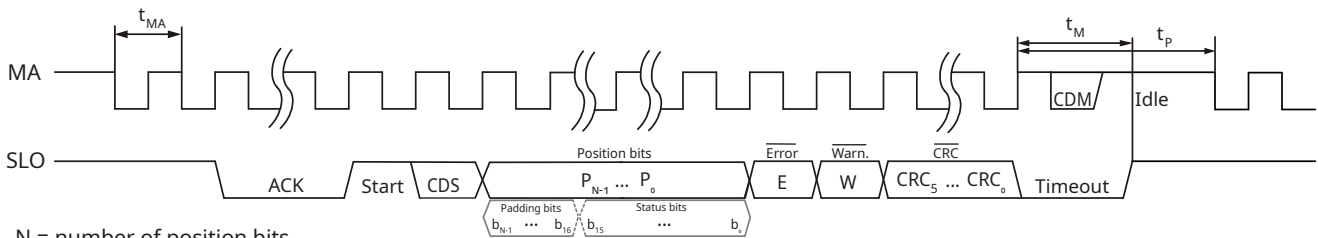

N = number of position bits

In case of an error, the position data field is replaced by the detailed status described on [page 12](#). The detailed status is 16 bits long and right-aligned. Other unused bits in the position field become padding bits and are set to zero. The exact length of the position data is determined by the combination of ring/scale and resolution. See the [Table of available resolutions](#).

BiSS C Parameters

Interface type	BiSS C unidirectional (point-to-point)
Signal level	RS422
Position data encoding	Pure binary
Max MA frequency	5 MHz
Min MA frequency	500 kHz
Length of position data	Depends on the resolution. See Table of available resolutions .
Length and type of status data	2 bits (Error, Warning). Active low. Error/warning descriptions, can be found in the LED table .
CRC length and type	6 bits (inverted bit output - polynomial 0x43)
ACK length	5 bits
CDS bit	Always zero
Communication delay	1.6 μs at 5 MHz MA freq.; otherwise 8 MA clock periods
Timeout	≥15 μs or when the SLO line goes high
Data frame rate	Up to 44 kHz

SSI Communication interface

The absolute position data and the status are available via the SSI protocol. The length of the position data varies depending on the combination of SAR ring, linear/partial arc scale and selected resolution. In combination with the SAR ring, the length of the position data is up to 23 bits. In combination with the scale, the length of the position data is up to 29 bits. The position data is always right-aligned, MSB first and without padding bits. The absolute position is followed by 2 general status bits, which are active low (error and warning), and 16 bits with detailed status.

Electrical connection

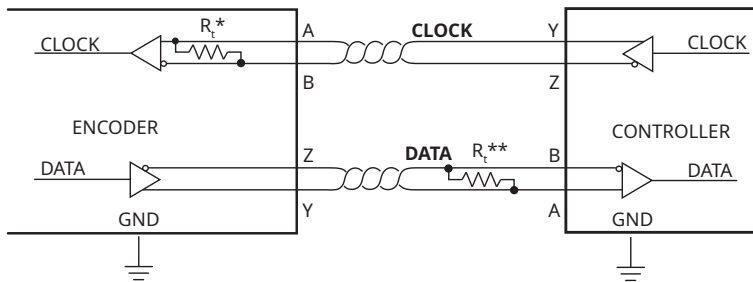

* The CLOCK and DATA lines are 5 V RS422 compatible differential pairs. The termination resistor on the CLOCK line is integrated in the encoder.

** Termination at the controller is required if the total cable length is more than 5 m. The nominal impedance of the cable is 120 Ω.

SSI timing diagram

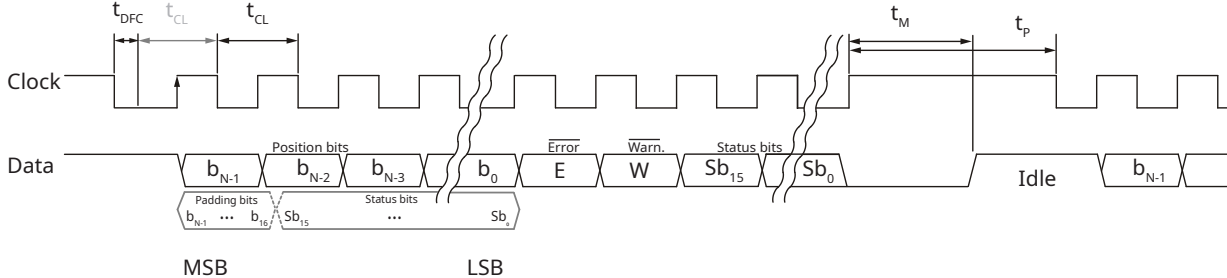

N = number of position bits

The detailed status bits follow the warning bit in the data frame. In case of an error, the position data field is also replaced by the detailed status described on **page 12**. The detailed status is 16 bits long and right-aligned. Other unused bits in the position field become padding bits and are set to zero. The exact length of the position data is determined by the combination of ring/scale and resolution. See the **Table of available resolutions**.

The controller requests the position and status data of the encoder by sending a pulse train to the Clock input. The Clock signal always starts from high. The first falling edge of the Clock latches the last position data available and on the first rising edge of the Clock the most significant bit (MSB) of the position is transmitted to the Data output. If the time t_{DFC} is extended for additional 2 μs, the maximum clock frequency limit is 2.5 MHz instead of 500 kHz. The Data output should then be read on the following falling edge. On subsequent rising edges of the Clock signal the next bits are transmitted.

After the transmission of the last bit the Data output goes to low. When the t_M time expires, the Data output goes high. The Clock signal must remain high for at least t_p before the next reading can take place.

While reading the data, the half of a Clock period t_{CL} must always be less than t_M . However, reading the encoder position can be terminated at any time by setting the Clock signal to high for the duration of t_M .

SSI Parameters

Interface type	SSI unidirectional (point-to-point)
Signal level	RS422
Position data encoding	Pure binary
Max CLOCK frequency	500 kHz (2.5 MHz with first clock delay function on the controller)
Min CLOCK frequency	80 kHz
Length of position data	Depends on the resolution. See Table of available resolutions .
Length and type of status data	2 bits (Error, Warning). Active low. Error/warning descriptions, can be found in the LED table .
Timeout t_M	$\geq 20 \mu\text{s}$ or when the DATA line goes high
Max request rate at highest resolution	Up to 25 kHz
Delay first clock t_{DFC}	2 - 10 μs
Pause time t_p	20 μs

Detailed status description

BiSS and SSI - detailed status replaces position data while error bit is active.

Bit number	Description of error/warning	Error / Warning	Clearing
b15	Reserved	/	/
b14	Temperature warning. Temperature has exceeded the upper specified limit (85 °C).	Warning	When absent
b13	Signal warning. The signals from the sensor are distorted. The encoder performance (noise, accuracy, ...) may not be as specified. Check if the readhead is installed within specification. The ring/readhead may be damaged.	Warning	When absent
b12	Reserved	/	/
b11	Decoding warning. The amplitude on the absolute sensor is too close to the limit for reliable decoding. Check the installation of the readhead and try to improve it.	Warning	When absent
b10	Overspeed warning. Refer to Maximum speed calculator for rings or Maximum speed calculator for scales . The rotational/linear speed is too high for the ABZ output to keep up. The ABZ output is now lagging behind the actual position. Continuing with this warning may result in overspeed error. Decrease the rotational/linear speed or use a readhead with different resolution and edge separation setting. This warning is only enabled if ABZ output is enabled.	Warning	When absent
b9	Reserved	/	/
b8	Sensors mismatch error. The positions of the absolute and incremental sensors do not match. This is likely due to a damaged ring/scale or external magnetic fields. It could be a result of using incompatible rings/scales. Check the orientation of the ring/scale relative to the readhead (the engraving sides must match).	Error	On communication

Detailed status continued

Bit number	Description of error/warning	Error / Warning	Clearing
b7	Decoding error. The amplitude on the absolute sensor is too low for reliable decoding. Check the installation of the readhead.	Error	When absent
b6	Signal error. The signals from the sensor are distorted beyond the ability to be reliably interpreted. Check if the readhead is installed within specification. Check the orientation of the ring/scale relative to the readhead (the engraving sides must match). The encoder system may be damaged.	Error	On communication
b5	Reserved	/	/
b4	System error. Malfunction inside the circuitry. To reset the System error bit, try to cycle the power supply while the rise time is shorter than 20 ms. If the error persists, contact RLS .	Error	On reset
b3	Reserved	/	/
b2	Overspeed error. The rotational/linear speed is too high for the interpolator to keep up, or the ABZ output has been lagging too far behind the actual position for the readhead to keep buffering the position. This error is only enabled if ABZ output is enabled. Decrease the rotational/linear speed or use a readhead with different resolution and edge separation setting. Refer to Maximum speed calculator for rings or Maximum speed calculator for scales .	Error	On communication
b1	Position uninitialized error. The conditions for calculating the valid absolute position have not yet been met. The error should clear on communication. If it persists, this could be due to the following: <ul style="list-style-type: none"> • The readhead mounting is incorrect. • The ring/scale is damaged. • The ring rotates at more than 500 rpm during the power up sequence or after the readhead is trying to recover from the error. • The linear speed is above 10 m/s during the power up sequence or after the readhead is trying to recover from the error. This error always sets in conjunction with other errors (except for decoding error). The error may also be set for a short period of time on first startup. However, it should clear automatically. If it does not, see reasons above.	Error	On communication (except first time after startup)
b0	Reserved	/	/

Output type

Incremental output

Output signals	3 square-wave signals A, B, Z and their inverted signals A-, B-, Z-
Reference signal	1 square pulse Z and its complementary pulse Z- per revolution (aligned with the absolute position zero)*
Signal level	Differential line driver according to EIA standard RS422
Permissible load	$Z_0 \geq 120 \Omega$ between associated outputs

* Unique Z signal is only present with the rings at absolute zero position.

Timing diagram

Complementary signals not shown

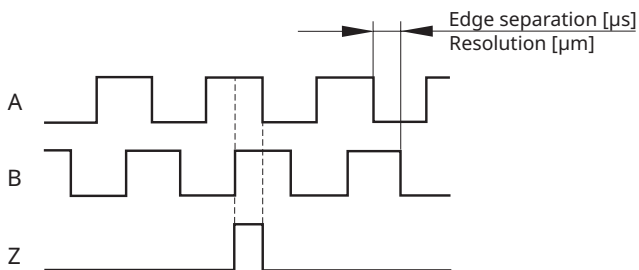

Recommended signal termination

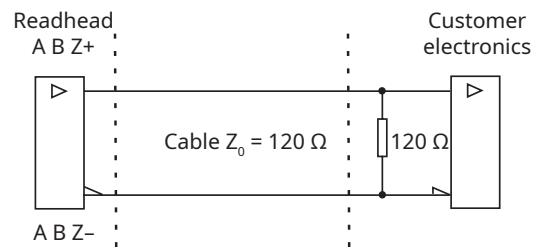

Cable length compensation

The readhead needs 70 ns to respond to incoming clocks (t_{RESP}). The change on the Data signal is delayed by 70 ns after the rising edge on the Clock line. An additional delay is caused by the time the signal takes to propagate through the cable to the readhead and back (t_{PROP}). This delay is typically 14 ns per 1 meter cable. The total cable length from the encoder to the receiver must be considered.

The total delay (t_{DELAY}) is calculated as in the formula below.

A proper implementation of BiSS Master should automatically measure t_{DELAY} and adjust the internal timing to compensate for it.

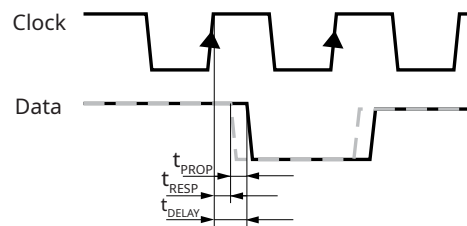

$$t_{DELAY} = t_{RESP} + t_{PROP} \times \text{cable length}$$

Current consumption vs. power supply

Measurement was made on the readhead with a 1 m long cable without termination.

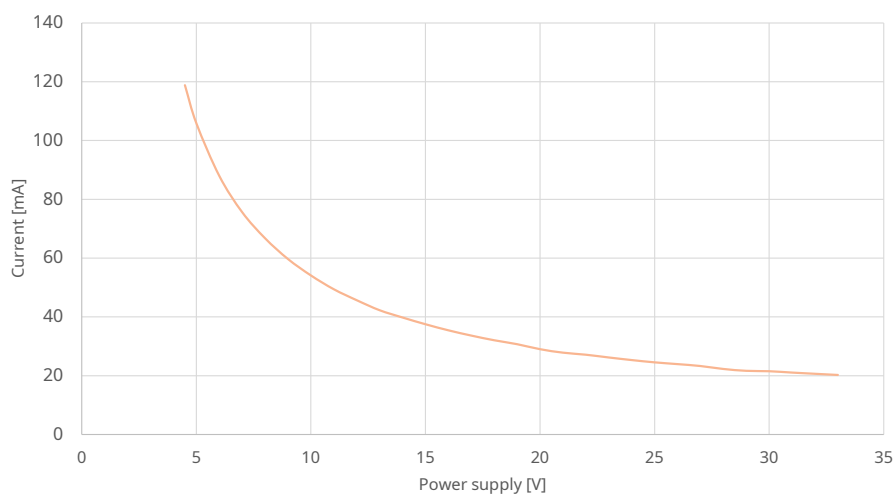

Part numbering

DBR 057 DC 23B A A S 000 H 00

Encoder family

- DBR** - Absolute readhead, PCB-A, for SAR rings
- DBL** - Absolute readhead, PCB-A, for linear and partial arc scales

Compatibility

Ring OD:

- 057** - 57 mm **229** - 229 mm
- 081** - 81 mm **325** - 325 mm
- 114** - 114.2 mm **478** - 478 mm
- 162** - 162 mm

Linear and partial arc scale

- 001** - DS19 (≤ 2 m, minimum bending diameter 200 mm, ± 10 μ m accuracy)
- 002** - DS19 ($2 \leq 8$ m, minimum bending diameter 630 mm, ± 10 μ m accuracy)

Linear scale

- 003** - DS19 ($8 \leq 32$ m, no bending allowed, ± 15 μ m accuracy)
- 004** - SAS19 (up to 1.36 m, ± 6 μ m accuracy)

Output type

- DC** - BiSS C output
- DI** - BiSS C + incremental output ABZ
- SC** - SSI output
- SI** - SSI + incremental output ABZ

Resolution

For rings (in CPR):

- | | | | |
|------------------------|------------------------|------------------------|------------------------|
| 23B - 8,388,608 | 18B - 262,144 | 0DB - 1,024,000 | 0IB - 512,000 |
| 22B - 4,194,304 | 17B - 131,072 | 0EB - 737,280 | 0JB - 360,000 |
| 21B - 2,097,152 | 0AB - 5,898,240 | 0FB - 368,640 | 0KB - 256,000 |
| 20B - 1,048,576 | 0BB - 2,949,120 | 0GB - 184,320 | 0LB - 180,000 |
| 19B - 524,288 | 0CB - 1,474,560 | 0HB - 720,000 | 0MB - 1,504,000 |

With the options DI and SI (ABZ enabled) the maximum resolution on the ABZ channel is 20 bits. If the resolution selected for the particular ring is higher than 20 bits, the ABZ resolution remains at 20 bits.

For linear and partial arc scales:

- | | | | | |
|----------------------------------|-------------------------------|----------------------------|---------------------------|--------------------------|
| 14U - 0.122070313 μ m | 10U - 1.953125 μ m | 06U - 31.25 μ m | 8D0 - 0.25 μ m | 010 - 10 μ m |
| 13U - 0.244140625 μ m | 09U - 3.90625 μ m | 05U - 62.5 μ m | 001 - 1.0 μ m | 10D - 0.1 μ m |
| 12U - 0.48828125 μ m | 08U - 7.8125 μ m | 04U - 125 μ m | 002 - 2 μ m | 20D - 0.2 μ m |
| 11U - 0.9765625 μ m | 07U - 15.625 μ m | 4D0 - 0.5 μ m | 005 - 5 μ m | |

Minimum edge separation

- | | | |
|------------------------------------|------------------------------------|---------------------------------|
| A - 0.02 μ s / 50 MHz | D - 0.14 μ s / 7.14 MHz | G - 1 μ s / 1 MHz |
| B - 0.04 μ s / 25 MHz | E - 0.26 μ s / 3.85 MHz | H - 2 μ s / 0.5 MHz |
| C - 0.08 μ s / 12.5 MHz | F - 0.50 μ s / 2 MHz | I - 4 μ s / 0.25 MHz |

Connector type

- H** - Horizontal connector
- V** - Vertical connector

Special requirements

- 00** - No special requirements
- 01** - Conformal coating

Not all part number combinations are valid. Refer to the table of available combinations on the following pages.

Table of available resolutions (DBR readhead with SAR rings)

Readhead	Outer diameter	Pole number	Compatible resolutions CPR (bits)	Position data length	Resolution part number
DBR	057	90	1,474,560	21	0CB
			737,280	20	0EB
			368,640	19	0FB
			184,320	18	0GB
			180,000	18	0LB
			1,048,576 (20)	20	20B
			524,288 (19)	19	19B
			262,144 (18)	18	18B
			131,072 (17)	17	17B
	081	128	2,097,152 (21)	21	21B
			1,048,576 (20)	20	20B
			524,288 (19)	19	19B
			262,144 (18)	18	18B
			256,000	18	0KB
	114	180	2,949,120	22	0BB
			1,474,560	21	0CB
			737,280	20	0EB
			368,640	19	0FB
			360,000	19	0JB
			2,097,152 (21)	21	21B
			1,048,576 (20)	20	20B
			524,288 (19)	19	19B
			262,144 (18)	18	18B
	162	256	4,194,304 (22)	22	22B
			2,097,152 (21)	21	21B
			1,048,576 (20)	20	20B
			524,288 (19)	19	19B
			512,000	19	0IB
	229	360	5,898,240	23	0AB
			2,949,120	22	0BB
			1,474,560	21	0CB
			737,280	20	0EB
			720,000	20	0HB
			4,194,304 (22)	22	22B
			2,097,152 (21)	21	21B
			1,048,576 (20)	20	20B
			524,288 (19)	19	19B
	325	512	8,388,608 (23)	23	23B
			4,194,304 (22)	22	22B
			2,097,152 (21)	21	21B
1,048,576 (20)			20	20B	
1,024,000			20	0DB	
478	752	8,388,608 (23)	23	23B	
		4,194,304 (22)	22	22B	
		2,097,152 (21)	21	21B	
		1,048,576 (20)	20	20B	
		1,504,000	21	0MB	

Further information can be found in the **SARD01** data sheet.

Table of available combinations (DBR readhead with SAR rings)

Series	Outer diameter	Output type	Resolution	N/A	Minimum edge separation	N/A	N/A	Connector type	Special requirements
DBR	057	DC / SC	17B / 18B / 19B / 20B / 0LB / 0GB / 0FB / 0EB / 0CB	A	A	S	000	H / V	00 / 01
	081		18B / 19B / 20B / 21B / 0KB						
	114		18B / 19B / 20B / 21B / 0JB / 0FB / 0EB / 0CB / 0BB						
	162		19B / 20B / 21B / 22B / 0IB						
	229		19B / 20B / 21B / 22B / 0HB / 0EB / 0CB / 0BB / 0AB						
	325		20B / 21B / 22B / 23B / 0DB						
	478		23B / 22B / 21B / 20B / 0MB						
	057	DI / SI	17B / 18B / 19B / 20B / 0LB / 0GB / 0FB / 0EB / 0CB						
	081		18B / 19B / 20B / 21B / 0KB						
	114		18B / 19B / 20B / 21B / 0JB / 0FB / 0EB / 0CB / 0BB						
	162		19B / 20B / 21B / 22B / 0IB						
	229		19B / 20B / 21B / 22B / 0HB / 0EB / 0CB / 0BB / 0AB						
	325		20B / 21B / 22B / 23B / 0DB						
	478		23B / 22B / 21B / 20B / 0MB						

With the options DI and SI (ABZ enabled) the maximum resolution on the ABZ channel is 20 bits. If the resolution selected for the particular ring is higher than 20 bits, the ABZ resolution remains at 20 bits.

Table of available resolutions (DBL readhead with SAS19/DS19 scale)

Readhead	Linear/partial arc scale	Interpolation factor	Resolution in μm	Position data length	Resolution part number
DBL	001 / 002 / 003 / 004	14	0.122070313	28	14U
		13	0.244140625	27	13U
		12	0.48828125	26	12U
		11	0.9765625	25	11U
		10	1.953125	24	10U
		09	3.90625	23	09U
		08	7.8125	22	08U
		07	15.625	21	07U
		06	31.25	20	06U
		05	62.5	19	05U
		04	125	18	04U
		8000	0.25	27	8D0
		4000	0.5	26	4D0
		2000	1	25	001
		1000	2	24	002
		400	5	23	005
		200	10	22	010
		20000	0.1	29	10D
		10000	0.2	28	20D

Table of available combinations (DBL readhead with SAS19/DS19 scale)

Series	Linear/partial arc scale	Output type	Resolution	N/A	Minimum edge separation	N/A	N/A	Connector type	Special requirements
DBL	001 / 002 / 003 / 004	DC / SC	14U / 13U / 12U / 11U / 10U / 09U / 08U / 07U / 06U / 05U / 04U / 8D0 / 4D0 / 001 / 002 / 005 / 010 / 10D / 20D	A	A	S	000	H / V	00 / 01
		DI / SI			A / B / C / D / E / F / G / H / I				

Accessories



USB interface (for SSI and BISS C)

E201-9S

For use with the readhead with up to 2 m long cable.



USB interface (ABZ incremental output)

E201-9Q

For use with options DI and SI.



Cable assembly, 1 m

ACC023

ACC023

Part number	Length	Diameter	Connector 1	Connector 2	Notes
ACC023	1 m	5 mm	Molex 501330-1200	Flying leads	Twisted pairs, shielded

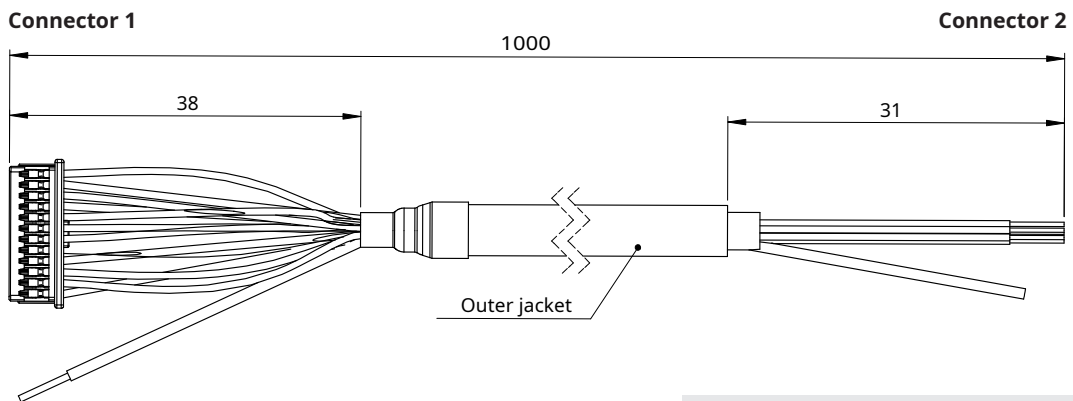

Dimensions in mm.

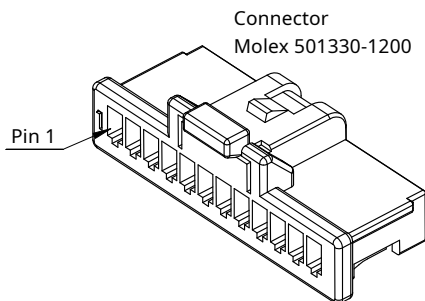

Molex 501330-1200

Pin number	Signal	Color
1	Z-	Grey
2	Z+	Pink
3	B-	Red
4	B+	Blue
5	A-	Yellow
6	A+	Green
7	GND	White
8	Vin	Brown
9	SLO- (data)	Red/Blue
10	SLO+ (data)	Grey/Pink
11	MA- (clock)	Black
12	MA+ (clock)	Violet

Head office

RLS Merilna tehnika d. o. o.

Poslovna cona Žeje pri Komendi
Pod vrbami 2
SI-1218 Komenda
Slovenia

T +386 1 5272100

E mail@rls.si

www.rls.si

Global support

Visit our [website](#) to contact your nearest sales representative.

Document issues

Issue	Date	Page	Description
5	12. 7. 2024	16	Minimum edge separation amended
6	23. 9. 2024	7	Environmental data amended
7	8. 10. 2024	19	Part numbering amended
8	23. 10. 2024	4	PCB thickness amended
9	11. 11. 2024	3, 7	Temperature data amended
10	14. 3. 2025	2, 16, 19 20	New options added for SAS19 Molex signal data amended

This product is not designed or intended for use outside the environmental limitations and operating parameters expressly stated on the product's data sheet. Products are not designed or intended for use in medical, military, aerospace, automotive or oil & gas applications or any safety-critical applications where a failure of the product could cause severe environmental or property damage, personal injury or death. Any use in such applications must be specifically agreed to by seller in writing, and is subject to such additional terms as the seller may impose in its sole discretion. Use of products in such applications is at buyer's own risk, and buyer will indemnify and hold harmless seller and its affiliates against any liability, loss, damage or expense arising from such use. Information contained in this data sheet was derived from product testing under controlled laboratory conditions and data reported thereon is subject to the stated tolerances and variations, or if none are stated, then to tolerances and variations consistent with usual trade practices and testing methods. The product's performance outside of laboratory conditions, including when one or more operating parameters is at its maximum range, may not conform to the product's data sheet. Further, information in the product's data sheet does not reflect the performance of the product in any application, end-use or operating environment buyer or its customer may put the product to. Seller and its affiliates make no recommendation, warranty or representation as to the suitability of the product for buyer's application, use, end-product, process or combination with any other product or as to any results buyer or its customer might obtain in their use of the product. Buyer should use its own knowledge, judgment, expertise and testing in selecting the product for buyer's application, end-use and/or operating environment, and should not rely on any oral or written statement, representation, or samples made by seller or its affiliates for any purpose. EXCEPT FOR THE WARRANTIES EXPRESSLY SET FORTH IN THE SELLER'S TERMS AND CONDITIONS OF SALE, SELLER MAKES NO WARRANTY EXPRESS OR IMPLIED WITH RESPECT TO THE PRODUCT, INCLUDING ANY WARRANTY OF MERCHANTABILITY OR FITNESS FOR ANY PARTICULAR PURPOSE, WHICH ARE DISCLAIMED AND EXCLUDED. All sales are subject to seller's exclusive terms and conditions of sale which, where the seller is (a) RLS Merilna tehnika d. o. o., are available at www.rls.si/customer-service, (b) Renishaw, Inc., are available at www.renishaw.com/Shop/legal/en/-42186, or (c) another person, are available on request, and in each case, are incorporated herein by reference, and are the exclusive terms of sale. No other terms and conditions apply. Buyer is not authorized to make any statements or representations that expand upon or extend the environmental limitations and operating parameters of the products, or which imply permitted usage outside of that expressly stated on the data sheet or agreed to in writing by seller.

RLS Merilna tehnika d. o. o. has made considerable effort to ensure the content of this document is correct at the date of publication but makes no warranties or representations regarding the content. RLS Merilna tehnika d. o. o. excludes liability, howsoever arising, for any inaccuracies in this document. © 2025 RLS d. o. o.