

AM256 – angular magnetic encoder IC

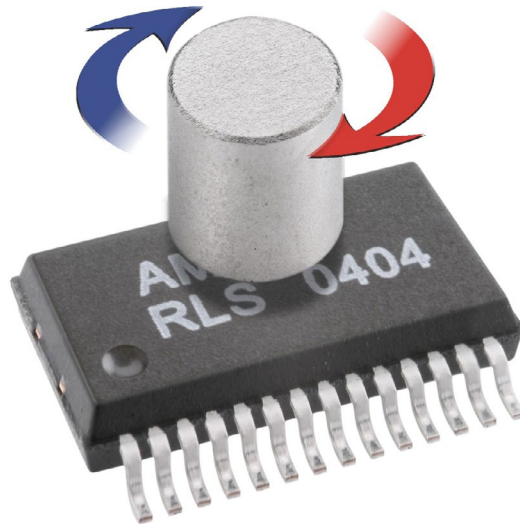

AM256 is not recommended for new designs. For more information please contact your local sales representative.

The AM256 is a compact solution for angular position sensing.

The IC senses the angular position of a permanent magnet placed above the chip. The permanent magnet must be diametrically polarized and of cylindrical shape.

The AM256 uses Hall sensor technology to detect the magnetic flux density distribution at the surface of the silicon. Hall sensors are placed in a circular array around the center of the IC and deliver a voltage representation of the magnetic field distribution.

The sine and cosine voltage outputs from the sensor array vary with magnet position. The sine and cosine signals are then converted to absolute angle position with a fast eight bit flash interpolator.

The absolute angle position value from the interpolator is output through a parallel binary interface or a serial SSI interface. The relative changes of the angle position are output through incremental A QUAD B encoder

signals. The resolution of incremental output is selectable between 128 and 256 counts per turn with an external pin.

With its compact size the AM256 angular magnetic encoder is especially suitable for different applications, including motor motion control, flow measurement, robotics, camera positioning, front panel switches, workshop equipment, mobility aids etc.

Output options:

- Incremental
- Parallel
- Serial SSI
- Analogue sinusoidal

- Contactless angular position encoding over 360°
- Ideal for harsh environments due to magnetic sensing
- Complete system-on-chip solution
- 8 bit absolute encoder
- Factory optimized linearity
- High rotational speed up to 60,000 rpm
- 5 V power supply
- Low power consumption. 13 mA typical.
- Extended operating temperature range (-40 °C to +125 °C)
- SMD package SSOP28
- RoHS compliant (lead free) - see Declaration of conformity

Pin description

Table shows the description for each pin of the standard SSOP 28 package.

Pin	Name	Pin description	
		PS = Low (parallel output)	PS = High (serial and incremental output)
1	Cos	Cosine analogue output for monitoring and filtering	Cosine analogue output for monitoring and filtering
2	Sin	Sine analogue output for monitoring and filtering	Sine analogue output for monitoring and filtering
3	I_{hal}	Input for Hall sensors bias current	Input for Hall sensors bias current
4	I_{boh}	Input for amplifiers bias current	Input for amplifiers bias current
5	Prog	OTP setup input * Connect to V_{ss}	OTP setup input * Connect to V_{ss}
6	Prg	OTP setup input * Do not connect	OTP setup input * Do not connect
7	V_{dd}	Power supply +5 V	Power supply +5 V
8	V_{ss}	Power supply 0 V	Power supply 0 V
9	D7/Data	D7 (MSB) bit of parallel output	Data output for SSI
10	D6	D6 bit of parallel outputs	Must leave unconnected
11	D5/CB	D5 bit of parallel outputs	Buffered cosine output **
12	D4/SB	D4 bit of parallel outputs	Buffered sine output **
13	D3/A	D3 bit of parallel outputs	Incremental output A
14	D2/Ri	D2 bit of parallel outputs	Incremental output Ri
15	D1/B	D1 bit of parallel outputs	Incremental output B
16	D0	D0 (LSB) bit of parallel outputs	Not used, must leave unconnected
17	V_{dd}	Power supply +5 V	Power supply +5 V
18	DL/SR	Data Latch (High = Data latch)	Set resolution ***
19	CS	If high then outputs from pin 9 to 16 are in high impedance	If high then outputs from pin 9 to 16 are in high impedance
20	Clock	Not used, must leave unconnected	Clock input for SSI
21	V_{ss}	Power supply 0 V	Power supply 0 V
22	V_{dd}	Power supply +5 V	Power supply +5 V
23	Agnd	Buffered analogue reference	Buffered analogue reference
24	Agndi	Analogue reference input	Analogue reference input
25	V_{ss}	Power supply 0 V	Power supply 0 V
26	V_{ss}	Power supply 0 V	Power supply 0 V
27	PS	Output mode selection	Output mode selection
28	Error	Output for monitoring	Output for monitoring

* Each AM256 is factory optimized to achieve optimum performance. The information is stored in PROM.

** Buffered analogue output mode must be factory set (special order).

*** The output resolution is selectable for incremental outputs only. When SR input is low then resolution is 64 ppr (pulses per revolution) if high then resolution is 32 ppr.

The AM256 has two output modes serial-incremental and parallel. The desired operational mode can be selected by pin PS. When the mode is changed, functions of some pins are changed.

Pins 7, 8, 17, 21, 22, 25, 26 are power supply pins. All pins must be connected.

Pins 1 and 2 are Cosine and Sine output signals for monitoring and filtering. A low-pass filter can be made with an external capacitor as there is a built-in 10 k Ω serial resistor. Recommended value for filtering is a 10 nF capacitor connected to V_{ss} . When a 10 nF capacitor is used for filtering the position information is delayed by an additional 100 μ s. See the "Position delay" section on page 8 for detailed information. These outputs can be used for monitoring the signals.

Pin 3 (I_{hal}) is used to define the system sensitivity. When a resistor (R_{ihal}) is connected from pin 3 (I_{hal}) to V_{dd} a hall sensor bias current is defined. Recommended value for R_{ihal} is 27 k Ω . The value of R_{ihal} can be altered to adjust the sensitivity. See the R_{ihal} /Signal amplitude characteristic chart on page 14.

Pin 4 (I_{boh}) is used to define the amplifiers bias current. When a resistor (R_{iboh}) is connected between pin 4 (I_{boh}) and V_{ss} amplifiers bias current is defined. The value R_{iboh} must be 82 k Ω .

Pins 5 and 6 are used for OTP (One Time Programming) of the chip. The OTP is carried out at the factory and defines the behavior and accuracy of the AM256. In operation pin 5 (Prog) must be connected to V_{ss} and pin 6 (Prg) must be unconnected.

Pins from 9 to 16 are output pins. The function of each pin is changed when the output mode is changed. See the "Pin description" table on page 2.

Pin 18 (DL/SR) is a digital input with an internal pull-down resistor. The function of the pin is changed when the output mode is changed. When parallel output mode is selected, the pin is used to latch (freeze) all 8 bits of information. When serial output mode is selected, the pin is used to select the incremental output resolution.

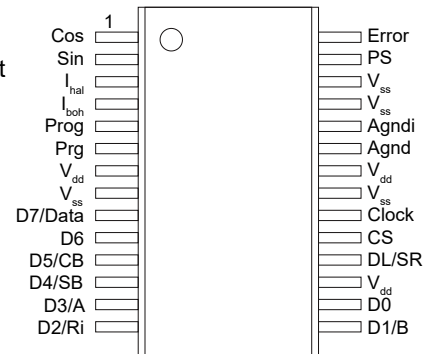

Fig. 1: Pin description

DL/SR	Function (parallel output mode)	Incremental output resolution (serial output mode)
Low	Parallel output is constantly refreshed	64 ppr
High	Parallel output information is latched	32 ppr

Pin 19 (CS) is a digital input with an internal pull-down resistor. When high, all digital output pins from 9 to 16 are set to high impedance mode. This function can be used when several AM256 devices are used in parallel mode. It does not affect the buffered sine cosine outputs.

Pin 20 (Clock) is a digital input for serial SSI communication. See the "Binary synchronous serial output SSI" section on page 5 for detailed information.

Pin 23 (Agnd) is a buffered analogue reference output. It is a reference voltage for analogue sinusoidal signals. It is used by the interpolator and for analogue signal outputs.

Pin 24 (Agndi) is an internally generated reference voltage. It is generated with a V_{dd}/V_{ss} resistor divider. The resistors values are 20 k Ω and 30 k Ω . The reference voltage is 3 V typically (3/5 of power supply voltage). Agndi must be connected to an external 100 nF capacitor. The voltage value can be changed with an external resistor if needed.

Pin 27 (PS) is a digital input pin with an internal pull-down resistor for selecting the output operation mode

PS	Output mode
Low	Parallel output mode
High	Serial and incremental output mode

Pin 28 (Error) is an analogue output signal. It can be used for monitoring the alignment between the AM256 and the magnet. See the "Error signal" section on page 12 for detailed information.

Absolute maximum ratings

$T_A = 22\text{ °C}$ unless otherwise noted

Parameter	Symbol	Min.	Max.	Unit	Note
Supply voltage	V_{dd}	-0.3	7	V	
Input pin voltage	V_{in}	-0.3	$V_{dd} + 0.7$	V	
Input current (latch-up immunity)	I_{scr}		50	mA	
Electrostatic discharge	ESD		2	kV	*
Junction temperature	T_j		160	°C	
Storage temperature range	T_{st}	-65	170	°C	
Humidity non-condensing	H	5	85	%	
Moisture sensitivity level			3		

* Human Body Model

Operating range conditions

Parameter	Symbol	Min.	Typ.	Max.	Unit	Note
Operating temperature range	T_o	-40		125	°C	
Supply voltage	V_{dd}	4.75	5	5.25	V	
Supply current	I_{dd}	10	13	20	mA	*
Input frequency	f_{in}			1	kHz	**
Power-up time	t_p			10	ms	***

* Supply current is changed if some external components are changed. Typ. figure is for recommended values; it does not include output drive currents.

** Input frequency is the magnet rotational speed.

*** Time between power-on and valid output data.

Digital outputs

Parameter	Symbol	Min.	Max.	Unit	Note
High level output voltage	V_{OH}	4	V_{dd}	V	at $I_H < 3\text{ mA}$
Low level output voltage	V_{OL}	V_{ss}	1	V	at $I_L < 3\text{ mA}$

Digital inputs

Parameter	Symbol	Min.	Max.	Unit	Note
High level input voltage	V_{IH}	3.5	V_{dd}	V	
Low level input voltage	V_{IL}	V_{ss}	1.5	V	

CW or CCW rotation of the magnet

The arrow shows clockwise (CW) rotation of the magnet.
The picture is a top view of the magnet placed above the AM256.
CCW is counterclockwise rotation.

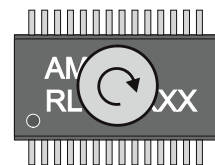

Fig. 2: CW rotation of the magnet

Binary synchronous serial output SSI

Serial output data is available in 8 bit binary code through the SSI protocol. Pin PS must be set high to activate the serial output mode.

By default, with CW rotation of the magnet the value of output data is increasing. It is possible to order an AM256 version with position increasing with CCW rotation of the magnet (special order).

Parameter	Symbol	Min.	Max.	Unit
Clock period	t_{CL}	1.2	16	μs
Clock high	t_{CHI}	0.6	15.6	μs
Clock low	t_{CLO}	0.6	15.6	μs
Monoflop time	t_m	16	22	μs

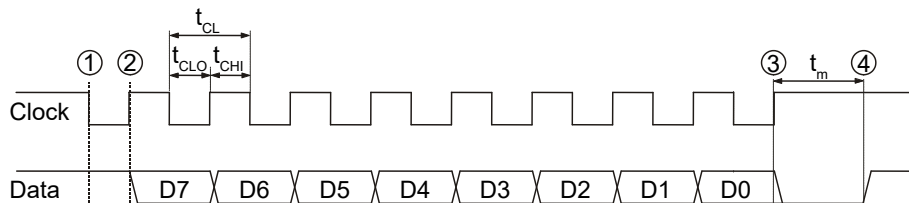

Fig. 3: SSI timing diagram

The controller interrogates the AM256 for its positional value by sending a pulse train to the Clock input. The Clock signal must always start from high. The first high/low transition (point 1) stores the current position data in a parallel/serial converter and the monoflop is triggered. With each transition of Clock signal (high/low or low/high) the monoflop is retriggered. At the first low/high transition (point 2) the most significant bit (MSB) of binary code is transmitted through the Data pin to the controller. At each subsequent low/high transition of Clock the next bit is transmitted to the controller. While reading the data the t_{CHI} and t_{CLO} must be less than t_{mMin} to keep the monoflop set. After the least significant bit (LSB) is output (point 3) the Data goes to low. The controller must wait longer than t_{mMax} before it can read updated position data. At this point the monoflop time expires and the Data output goes to high (point 4).

It is possible to read the same position data several times to enlarge the reliability of transmitted data. The controller must continue sending the Clock pulses and the same data will be output again. Between the two outputs one logic zero will be output.

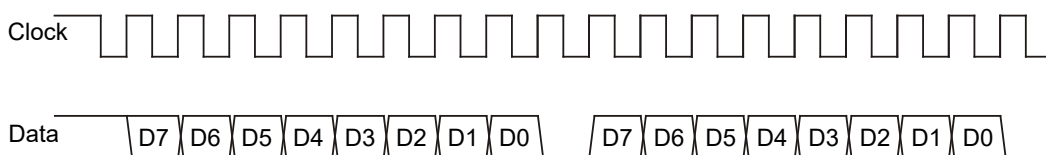

Fig. 4: SSI multi-read of the same position data

Binary parallel output

Parallel output data is available in 8 bit binary code. To activate parallel output the PS pin must be set low. Output data can be latched while reading the data.

For CW rotation of the magnet the output position is increasing. It is possible to order an AM256 version with position increasing for CCW rotation of the magnet (special order).

Incremental output

There are three signals for incremental output: A, B and Ri. Signals A and B are quadrature signals, shifted by 90°, and signal Ri is a reference mark. Three different numbers of pulses per revolution for quadrature signals are available: 64 ppr, 32 ppr (selectable with an external pin). When 64 ppr is selected, the number of counts per revolution post quadrature evaluation is 256 ($64 \times 4 = 256$). The reference mark signal is produced once per revolution. The width of the Ri pulse is 1/4 of the quadrature signal period.

Chart below shows the timing diagram of A, B and Ri signals with CW rotation of the magnet at 64 ppr resolution. B leads A for CW rotation of the magnet. The counting direction can be changed by swapping the A and B signals.

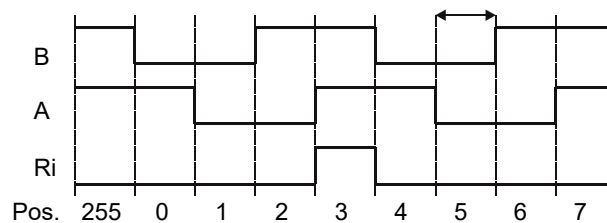

Fig. 5: Timing diagram for incremental output

Edge separation time for 64 ppr:

Parameter	Symbol	Ideal	Min.	Unit	Note
Edge separation time	t_{ES}	39	25	μs	at 6,000 rpm
Edge separation time	t_{ES}	7.8	4.5	μs	at 30,000 rpm

Sinusoidal analogue outputs

Agnd is an internally generated reference voltage. Typical value for Agnd is 3/5 of V_{dd} (3 V at 5 V power supply). It is used as a zero level for the analogue signals and it is buffered. The internal serial impedance of the buffer for reference voltage is 60 Ω .

Pins 1 and 2 are unbuffered sinusoidal analogue outputs and they must only be used with a high impedance load.

Unbuffered sinusoidal outputs:

Parameter	Symbol	Typ.	Unit	Note
Internal serial impedance	R_n	10	k Ω	
Short circuit current	I_o	150	μA	at signal amplitude 1.5 V, connected to Agnd

Buffered analogue outputs can be provided on pins 11 and 12 (special order). Note that it is not possible to have parallel and buffered analogue outputs at the same time.

Buffered sinusoidal outputs:

Parameter	Symbol	Typ.	Unit	Note
Internal serial impedance	R_n	720	Ω	
Short Circuit current	I_0	2	mA	at signal amplitude 1.5 V, connected to Agnd

Timing diagram shows CW rotation of the recommended magnet.

Sinusoidal outputs produce one period of sine and cosine signal per turn with a phase difference of 90° . Each signal has the same amplitude and minimum offset with respect to Agnd.

Sinusoidal output parameters are factory optimized to achieve the best possible accuracy. However, the specified accuracy parameters are only valid for magnets specified and used within alignment tolerances. When a load is applied to the analogue outputs the amplitude is slightly reduced. The load must be the same for both channels to preserve the symmetry.

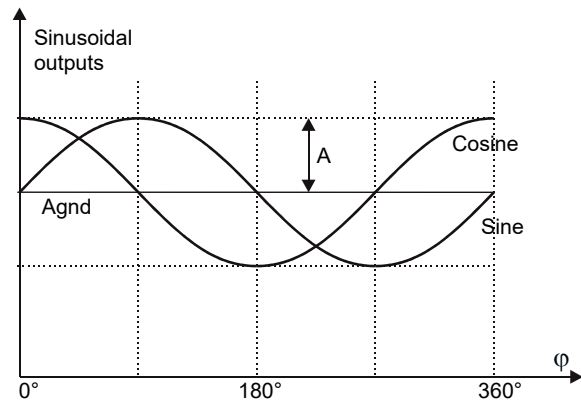

Fig. 6: Timing diagram for analogue output

Sinusoidal signal parameters:

Parameter	Symbol	Min.	Typ.	Max.	Unit	Note
Amplitude	A	0.6	1.1	1.9	V	*
Amplitude difference	ΔA_{SC}			0.2	%	**
Offset Sine	V_{OSIN}			3	mV	**
Offset Cosine	V_{OCOS}			3	mV	**
Phase error	$\Delta\phi$			0.2	deg	**
Maximum output frequency	f_{Max}	1			kHz	

* Amplitude = 1/2 of peak to peak value. At $V_{dd} = 5 V$.

** Parameters are only valid for ideal shape and position of the magnet. Additional errors can occur if magnet setup position is not achieved. See the "Mounting instructions" section on page 11 for additional information.

Hysteresis

The AM256 uses an electrical hysteresis when converting analogue signals to digital. The hysteresis prevents the flickering of the digital output at a stationary magnet position. The effect is a position hysteresis when rotating the magnet CW or CCW.

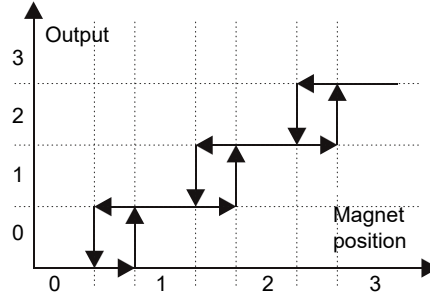

Fig. 7: Hysteresis

Parameter	Symbol	Min.	Typ.	Max.	Unit	Note
Hysteresis	Hyst.	0.3	0.45	0.6	deg	*

* The hysteresis depends on the signal amplitude. A higher amplitude means a lower hysteresis.

Position delay

At high rotational speed a position delay between the magnet position and the electrical output appears because of filtering. Filtering is carried out with an RC filter. The value of the resistor is 10 kΩ and the recommended value of the capacitor is 10 nF. Position delay can be calculated as follows:

$$\Delta\varphi = \text{Arc tan}\{f / f_0\} \quad (f = \text{frequency}, f_0 = (2\pi RC)^{-1})$$

The filtering capacitor value can be reduced to 3 nF to reduce the position delay. At high rotational speed the amplitude decreases.

Parameter	Symbol	Typ.	Unit	Note
Position delay	$\Delta\varphi_{\text{pos}}$	0.36	deg	at 10 Hz, C = 10 nF
		3.6		at 100 Hz, C = 10 nF
		0.1		at 10 Hz, C = 3 nF
		1		at 100 Hz, C = 3 nF
Amplitude decreasing	ΔA	0.2	%	at 100 Hz, C = 10 nF
		15.3		at 1 kHz, C = 10 nF

Nonlinearity

Nonlinearity is defined as the difference between the actual angular position of the magnet and the angular position output from the AM256. Readings are compared at each output position change.

Integral nonlinearity is the total position error of the AM256 output. Figure 8 on page 9 shows a typical error plot if the recommended magnet is carefully positioned. Figure 9 shows the error plot if the magnet is on the limit of alignment tolerances. Integral nonlinearity includes magnet misalignment error, differential nonlinearity and transition noise.

Differential nonlinearity is the difference between the measured position step and the ideal position step. Figure 10 on page 9 shows a typical differential nonlinearity plot. This is a function of the interpolator accuracy. Differential nonlinearity is repeatable to the transition noise if it is re-measured.

The difference between two differential measurements represents the transition noise. Transition noise is a consequence of electrical noise in the analogue signals (see Figure 11).

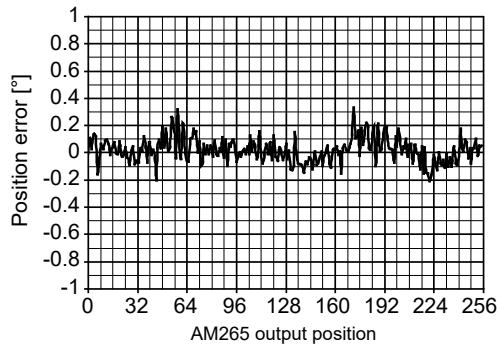

Fig. 8: Typical integral nonlinearity plot with good magnet setup

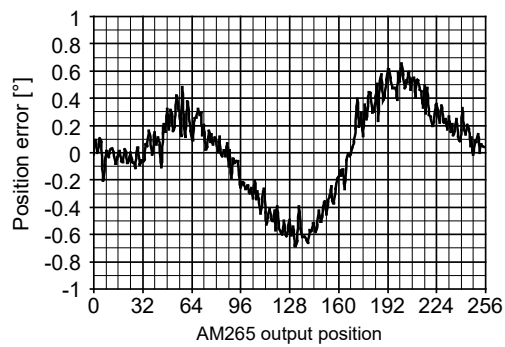

Fig. 9: Typical integral nonlinearity plot if the magnet is on the limit of alignment tolerances

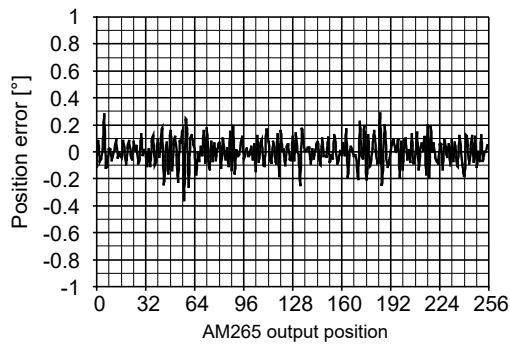

Fig. 10: Typical differential nonlinearity plot

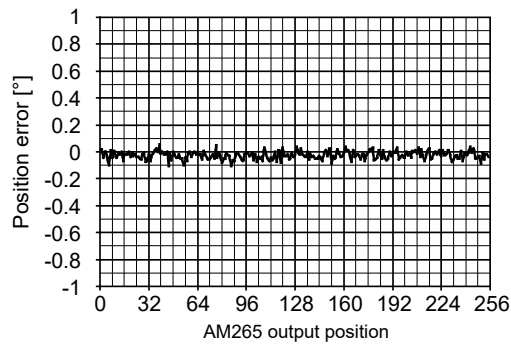

Fig. 11: Typical plot of transition noise

Parameter	Symbol	Typ.	Unit	Note
Maximum integral nonlinearity	INL_{Max}	± 0.6	deg	*
Maximum differential nonlinearity	DNL_{Max}	± 0.4	deg	0.1 deg RMS
Maximum transition noise	TN_{Max}	± 0.2	deg	0.03 deg RMS

* If recommended magnet is used at optimum setup position.

Recommended magnet

The AM256 can be supplied with a pre-selected magnet to ensure that optimum performance is achieved. Alternatively, magnets can be sourced from other suppliers but they must conform to the following guidelines to ensure that performance specifications can be achieved.

To select a suitable magnet it is important to know the properties of the sensors. Hall sensors are only sensitive to the perpendicular component of the magnetic flux density (B). The AM256 has a Hall sensor array arranged in a circle with a radius of 1.5 mm. Sensors are located on the surface of the silicon.

Magnets must be cylindrical in shape and diametrically polarized. The main criterion for magnet selection is the modulation of the perpendicular component of magnetic flux density at the location of the sensors (B_n).

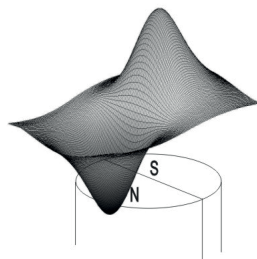

Fig. 12: Distribution of the perpendicular component of B

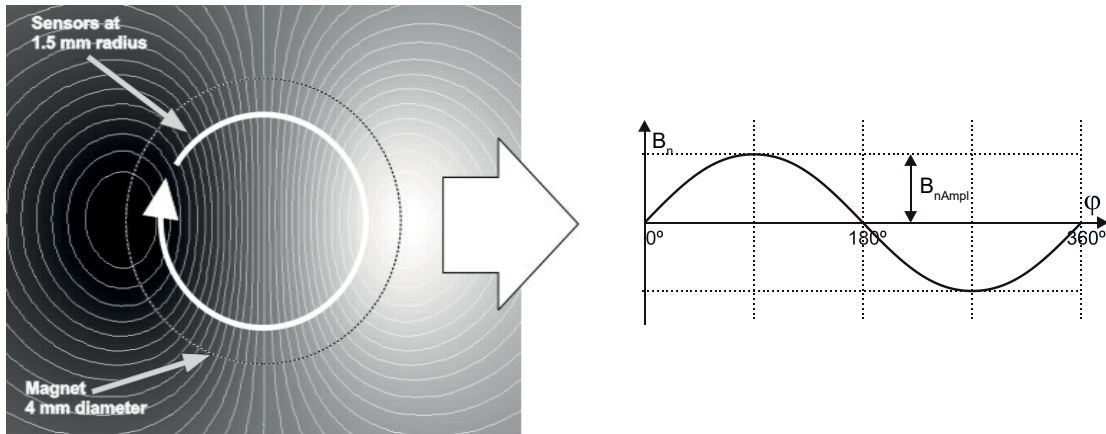

Fig 13: Distribution of B_n and its modulation if the magnet is rotated through 360°

Parameter	Symbol	Min.	Typ.	Max.	Unit	Note
Amplitude of B_n modulation	B_{nAmpl}		510		Gauss	*
Offset of B_n modulation	$B_{nOffset}$	0		± 30	Gauss	**

* Typical value of B_{nAmpl} will give an analogue signal output with an amplitude of 1.1 V. The amplitude of the signal is proportional to the B_{nAmpl} . 1 Tesla equals 10,000 Gauss.

** Offset affects the integral nonlinearity if the magnet is not aligned correctly with respect to the chip.

We recommend that a magnet with the following parameters is used to provide the necessary modulation:

Parameter	Typ.	Unit	Note
Diameter	4	mm	
Length	4	mm	
Material	Sm2Co17		*
Material remanence	10.5	kGauss	
Temperature coefficient	-0.03	% / °C	
Curie temperature	720	°C	

* Rare earth material magnets SmCo are recommended; however, NdFeB magnets can be used but they have different characteristics.

Magnet position

The magnet can be placed below or above the device. The typical distance between the magnet and the sensors must be 1.8 mm for the recommended magnet.

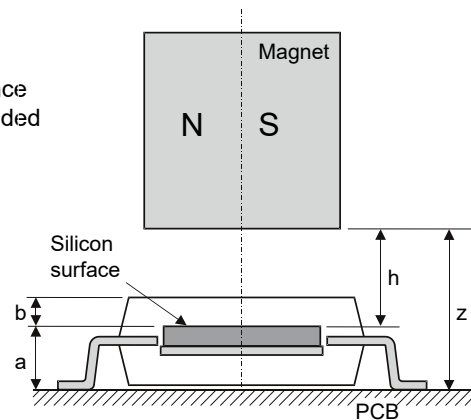

Fig. 14: Cross section of the AM256 with dimensions

Parameter	Symbol	Min.	Typ.	Max.	Unit	Note
Distance sensors – PCB plane	a		1.25		mm	
Distance sensors – chip surface	b		0.61		mm	
Distance sensors – magnet	h	1.6	1.80	2.0	mm	For recommended magnet
Distance magnet – PCB plane	z	2.85	3.05	3.25	mm	For recommended magnet

Mounting instructions

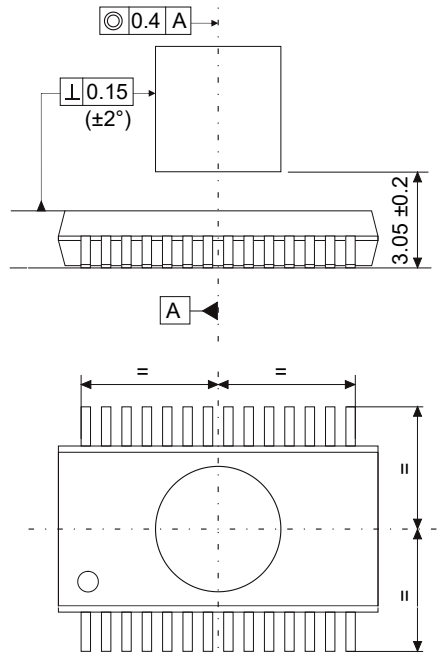

Fig. 15: Magnet position

Magnet quality and the nonlinearity error

Each AM256 is optimized during the production to give best performance with an ideal magnet when perfectly aligned.

An ideal magnet would have the polarization border exactly in the middle of the magnet. In reality this is impossible to achieve repeatably.

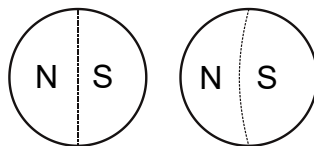

Fig. 16: Ideally polarized magnet and not ideally polarized magnet

If the polarization is not exactly in the middle of the magnet then the modulation of the magnetic field has an offset. The offset represents a mean value of B_n when the magnet is rotated through 360° and B_n is measured at 1.8 mm distance from the magnet surface and at 1.5 mm radius.

Offset will cause larger than normal integral nonlinearity errors if the AM256 placement is not in the center of the magnet rotation.

Figure 17 shows the additional integral nonlinearity error caused by misalignment of the AM256 for ideal and recommended magnets.

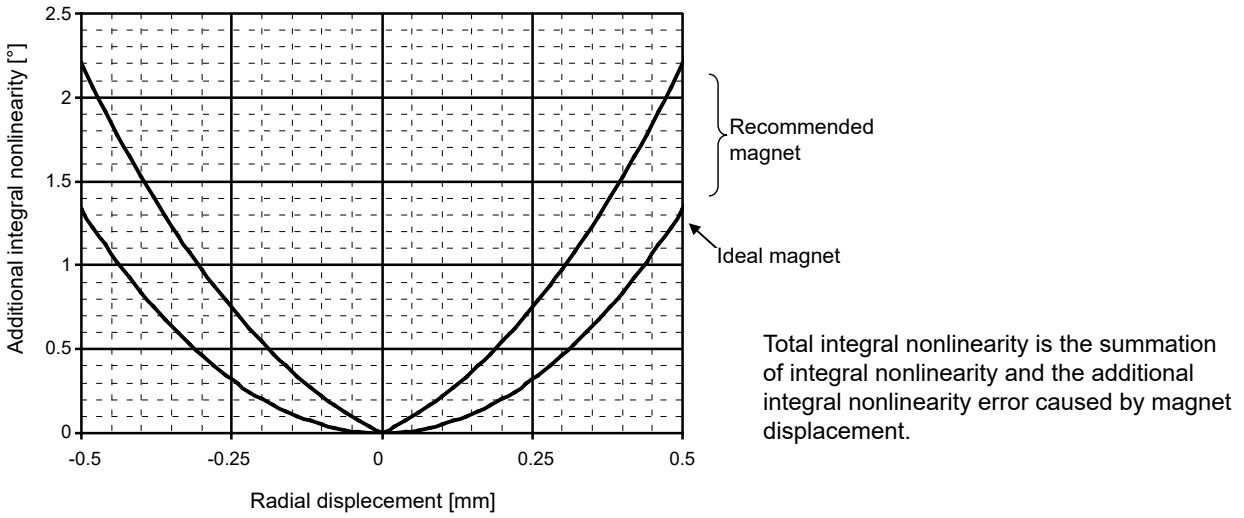

Fig. 17: Additional integral nonlinearity error caused by magnet displacement and quality

Error signal

Error signal can be used for alignment of the AM256. The error signal is sinusoidal in shape with one period per turn. The amplitude of the error signal is proportional to the AM256 displacement. To achieve optimum setup the amplitude of the error signal should be minimized.

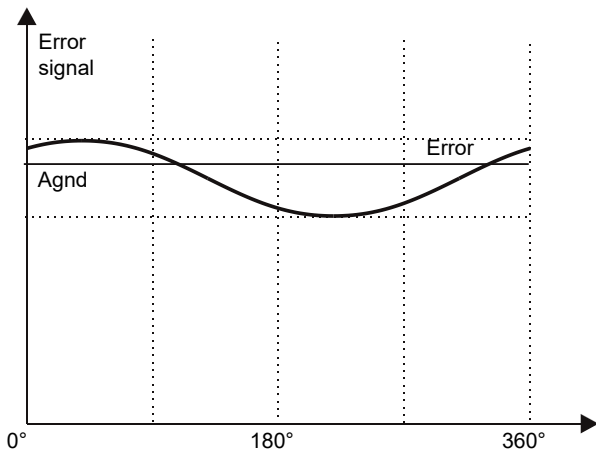

Fig. 18: Error signal shape

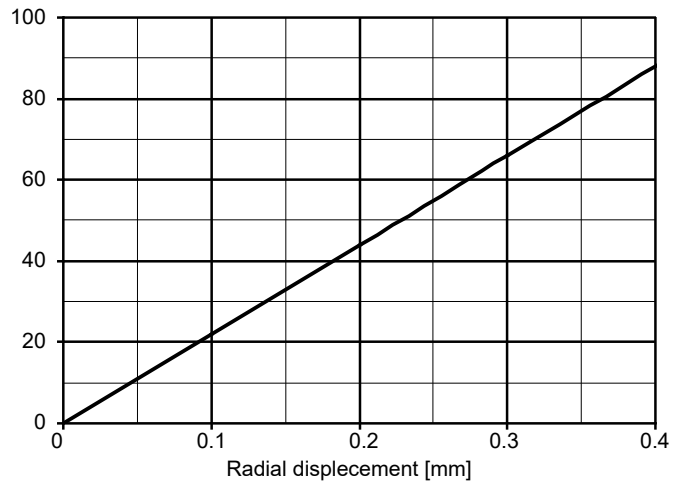

Fig. 19: Error signal amplitude

Typical applications

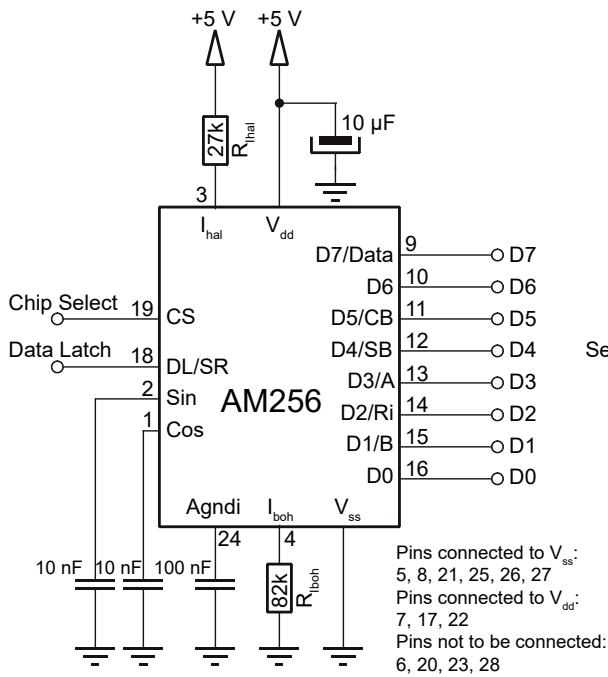

Fig. 20: Parallel output

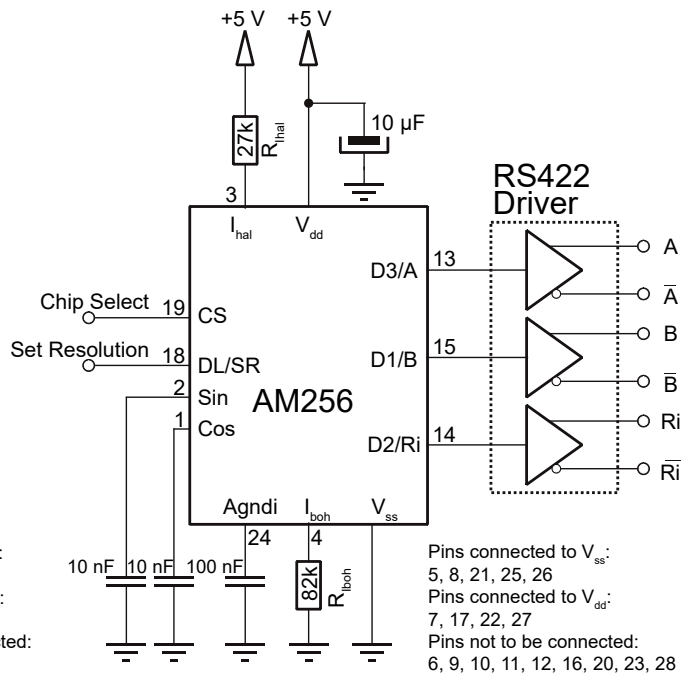

Fig. 21: Incremental output

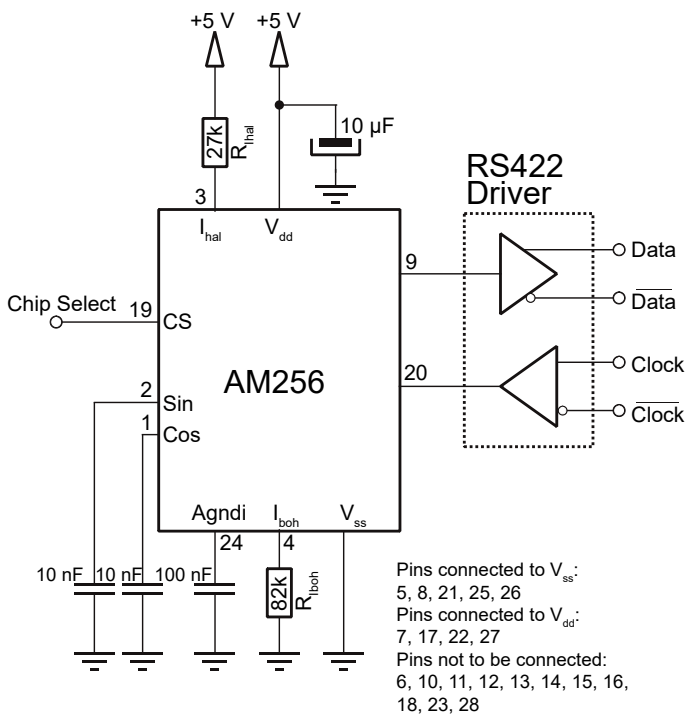

Fig. 22: SSI output

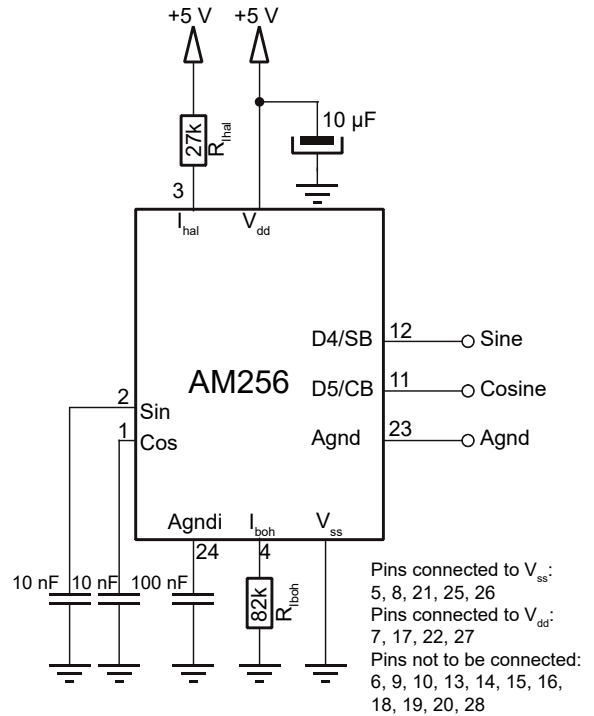

Fig. 23: Buffered analogue output (for AM256S only)

NOTE: Incremental and SSI outputs can be used simultaneously.

Characteristics

All characteristics are measured at recommended conditions unless otherwise stated.

Recommended conditions:

Parameter	Symbol	Value	Unit	Note
Ambient temperature	T_A	22	°C	
Distance magnet-sensors	h	1.80	mm	
Signal amplitude	A	1.1	V	Min. 0.6 V, Max. 1.9 V
Power supply	V_{dd}	5	V	
Resistor for Ihal setup	R_{Ihal}	27	k Ω	
Resistor for Iboh setup	R_{Iboh}	82	k Ω	Do not change
Magnet				Recommended magnet

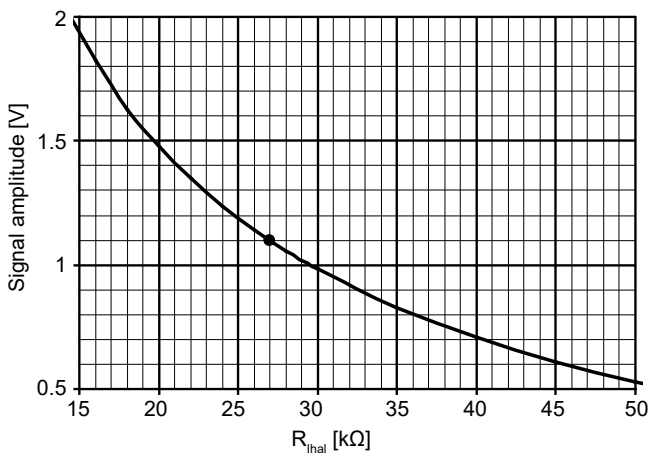

Fig. 24: Signal amplitude as a function of R_{Ihal}

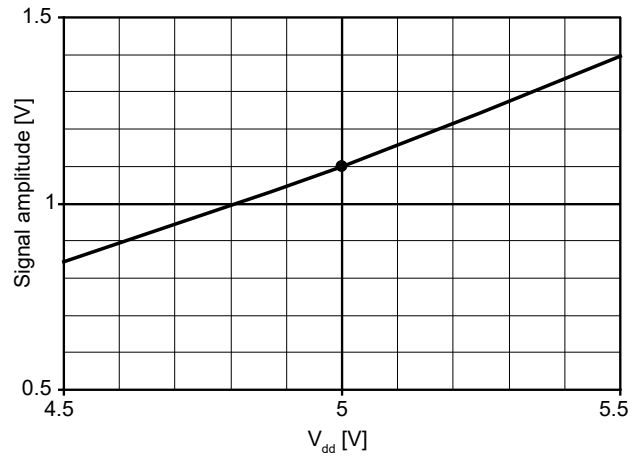

Fig. 25: Signal amplitude as a function of supply voltage

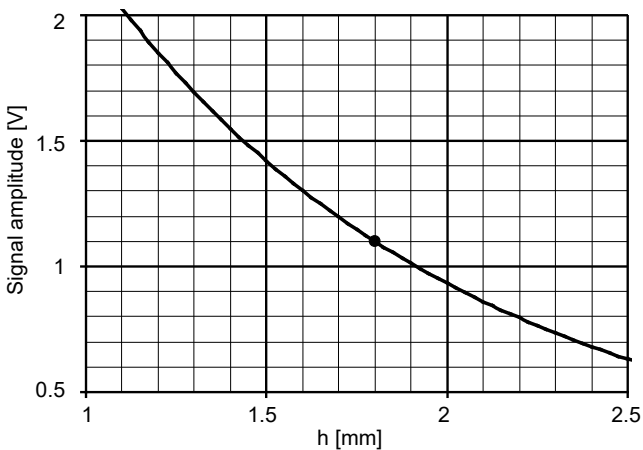

Fig. 26: Signal amplitude as a function of h

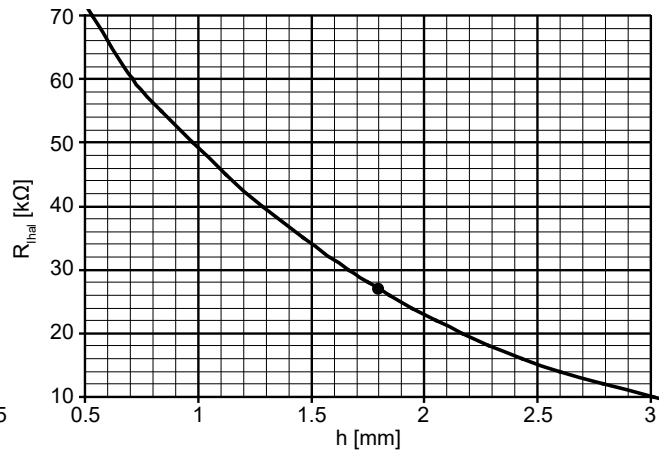

Fig. 27: R_{Ihal} to maintain signal amplitude at different h

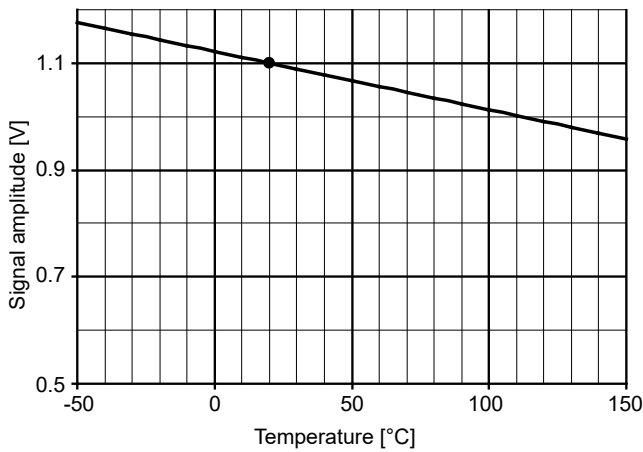

Fig. 28: Signal amplitude as a function of temperature

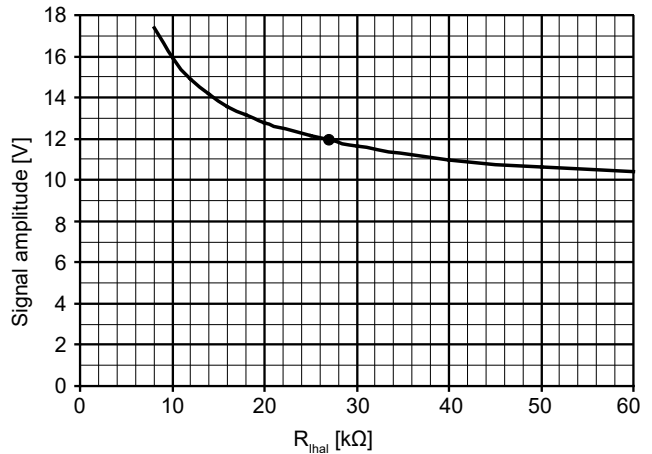

Fig. 29: Supply current as a function of R_{ihal}

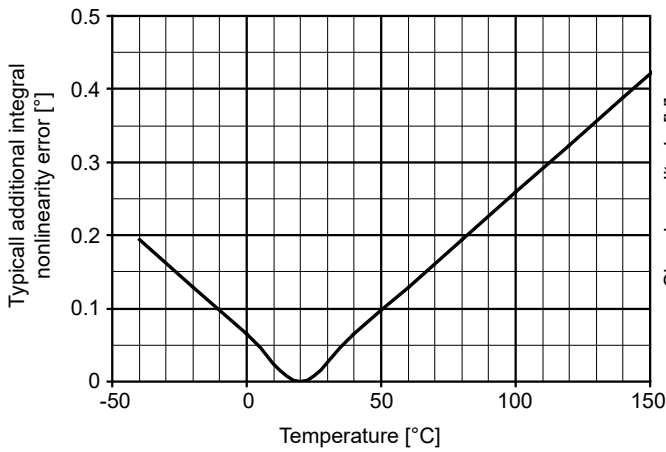

Fig. 30: Typical additional error as a function of temperature

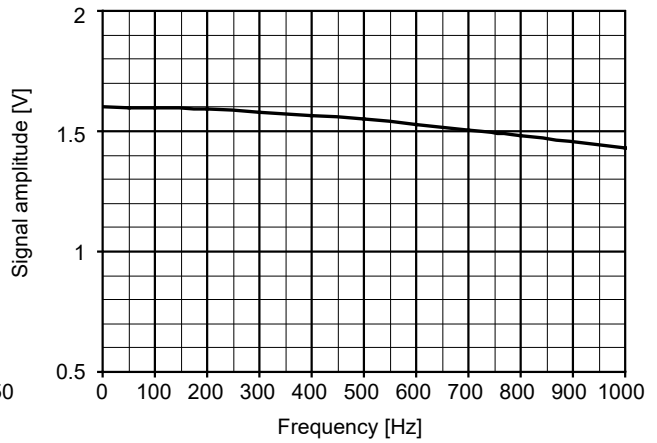

Fig. 31: Signal amplitude as a function of frequency

SSOP28 package dimensions

Dimensions:

Symbol	Min.	Typ.	Max.	Unit
A			2	mm
A1	0.05			mm
A2	1.65	1.75	1.85	mm
b	0.22		0.38	mm
c	0.09		0.25	mm
D	9.9	10.2	10.5	mm
E	7.4	7.8	8.2	mm
E1	5	5.3	5.6	mm
e		0.65		mm
K	0		10	deg
L	0.55	0.75	0.95	mm

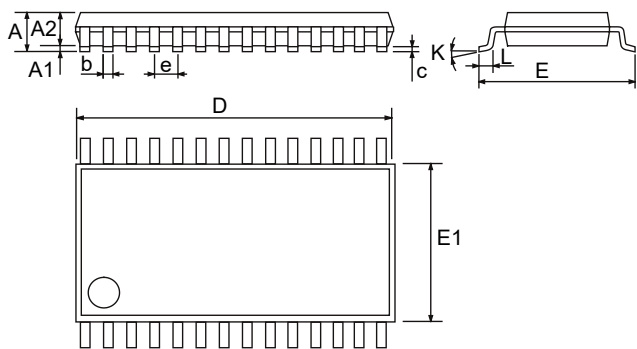



Fig. 32: Dimensional drawing

Ordering information

1. Angular magnetic encoder IC

Part number	Description
AM256PT 	AM256 angular magnetic encoder IC with default functionality Outputs: - Parallel - SSI - Incremental - Unbuffered Sine/Cosine SSOP28 plastic package Delivered in tubes (48 units per tube)
AM256SPT 	AM256 angular magnetic encoder IC with buffered Sine/Cosine output Outputs: - Buffered Sine/Cosine SSOP28 plastic package Delivered in tubes (48 units per tube)

NOTE: Order quantity must be a multiple of 48 (one tube).



NOTE: Can be delivered in reels (special order).

NOTE: Magnet must be ordered separately! The angular magnetic encoder IC part number does not include a magnet.

2. Magnet

Part number	Description
RMM44A2C00 	Diametrically polarized magnet Dimensions: Ø4 mm × 4 mm

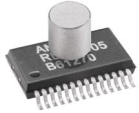
3. Sample kits

Part number	Description
AM256KIT 	AM256 angular magnetic encoder IC with a magnet, delivered in an antistatic box. Outputs: Parallel, SSI, Incremental, Unbuffered Sine/Cosine.
RMK2 	AM256 angular magnetic encoder IC, on a PCB with all necessary components and a magnet, delivered in an antistatic box. Outputs: Parallel, SSI, Incremental, Unbuffered Sine/Cosine.

NOTE: Maximum order quantity for AM256KIT is 10 pcs. For larger quantities chip and magnet should be ordered separately.

RMK2 evaluation board

AM256 angular magnetic encoder IC on a PCB with all necessary components and a magnet, delivered in an antistatic box. RMK2 is evaluation board, not suitable for mass production.

Outputs: Parallel, SSI, Incremental, Unbuffered Sine/Cosine

Connections

Vss	Vdd
Clock	DL/SR
D0	CS
D2/Ri	D1/B
Cos	Sin
D4	D3/A
D6	D5
PS	D7/Data

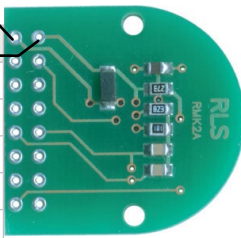

Fig. 33: RMK2 pin assignment

NOTE: The connection pads are on 100 mils grid.

Dimensions

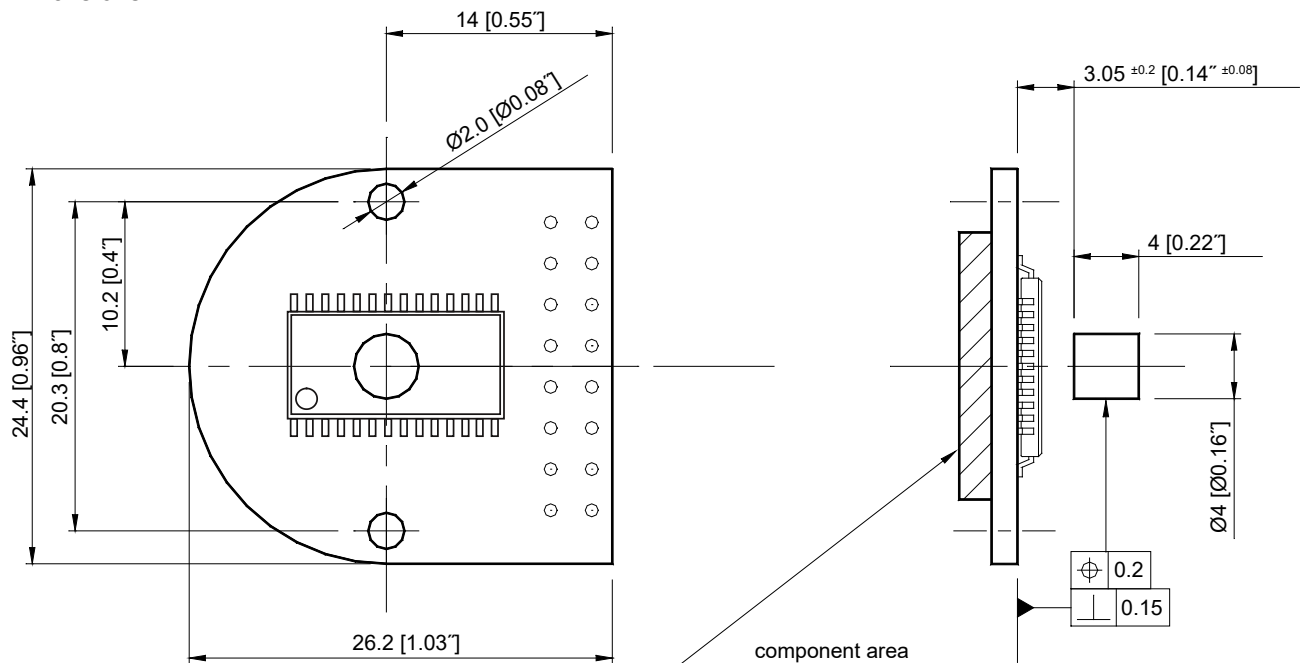

Fig. 34: Dimensional drawing with installation tolerances

For RMK2 sample request please visit www.rls.si/am256.

Head office

RLS merilna tehnika d.o.o.

Poslovna cona Žeje pri Komendi
Pod vrbami 2
SI-1218 Komenda
Slovenia

T +386 1 5272100

F +386 1 5272129

E mail@rls.si

www.rls.si

Document issues

Issue	Date	Page	Corrections made
7	2. 2. 2007	1	Added RoHS compliance bullet under Features
		19	Corrected polarity sign for power supply socket
8	24. 4. 2007	General	New layout
		5	Changed clock timing in table for SSI output
		12	Corrected Mounting instructions diagram
		20	Changed contact information
9	14. 1. 2009	General	New layout
		6	New SSI timing diagram
10	29. 3. 2010	General	Removed the 16 ppr resolution
11	9. 9. 2015	General	New layout
12	4. 1. 2016	4	Moisture sensitivity level added
		16, 17	RMK2 kit photo corrected
13	22. 5. 2017	2	10 μ s amended to 100 μ s
14	30. 7. 2024	1	Not recommended for new designs added

This product is not designed or intended for use outside the environmental limitations and operating parameters expressly stated on the product's datasheet. Products are not designed or intended for use in medical, military, aerospace, automotive or oil & gas applications or any safety-critical applications where a failure of the product could cause severe environmental or property damage, personal injury or death. Any use in such applications must be specifically agreed to by seller in writing, and is subject to such additional terms as the seller may impose in its sole discretion. Use of products in such applications is at buyer's own risk, and buyer will indemnify and hold harmless seller and its affiliates against any liability, loss, damage or expense arising from such use. Information contained in this datasheet was derived from product testing under controlled laboratory conditions and data reported thereon is subject to the stated tolerances and variations, or if none are stated, then to tolerances and variations consistent with usual trade practices and testing methods. The product's performance outside of laboratory conditions, including when one or more operating parameters is at its maximum range, may not conform to the product's datasheet. Further, information in the product's datasheet does not reflect the performance of the product in any application, end-use or operating environment buyer or its customer may put the product to. Seller and its affiliates make no recommendation, warranty or representation as to the suitability of the product for buyer's application, use, end-product, process or combination with any other product or as to any results buyer or its customer might obtain in their use of the product. Buyer should use its own knowledge, judgment, expertise and testing in selecting the product for buyer's application, end-use and/or operating environment, and should not rely on any oral or written statement, representation, or samples made by seller or its affiliates for any purpose. EXCEPT FOR THE WARRANTIES EXPRESSLY SET FORTH IN THE SELLER'S TERMS AND CONDITIONS OF SALE, SELLER MAKES NO WARRANTY EXPRESS OR IMPLIED WITH RESPECT TO THE PRODUCT, INCLUDING ANY WARRANTY OF MERCHANTABILITY OR FITNESS FOR ANY PARTICULAR PURPOSE, WHICH ARE DISCLAIMED AND EXCLUDED. All sales are subject to seller's exclusive terms and conditions of sale which, where the seller is (a) RLS merilna tehnika d.o.o., are available at <https://www.rls.si/customer-service>, (b) Renishaw, Inc., are available at <http://www.renishaw.com/Shop/legal/en/-42186>, or (c) another person, are available on request, and in each case, are incorporated herein by reference, and are the exclusive terms of sale. No other terms and conditions apply. Buyer is not authorized to make any statements or representations that expand upon or extend the environmental limitations and operating parameters of the products, or which imply permitted usage outside of that expressly stated on the datasheet or agreed to in writing by seller.

RLS merilna tehnika d.o.o. has made considerable effort to ensure the content of this document is correct at the date of publication but makes no warranties or representations regarding the content. RLS merilna tehnika d.o.o. excludes liability, howsoever arising, for any inaccuracies in this document. © 2024 RLS d.o.o.