

RMB28 / RMF44 angular magnetic encoder modules

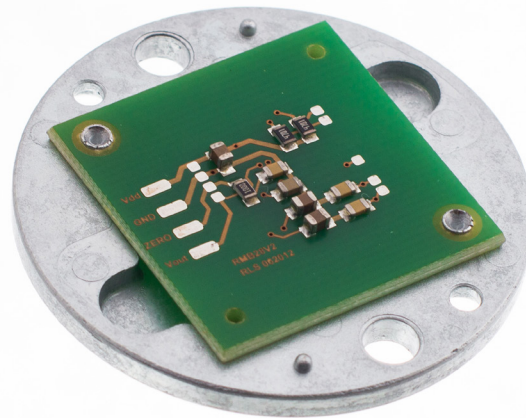
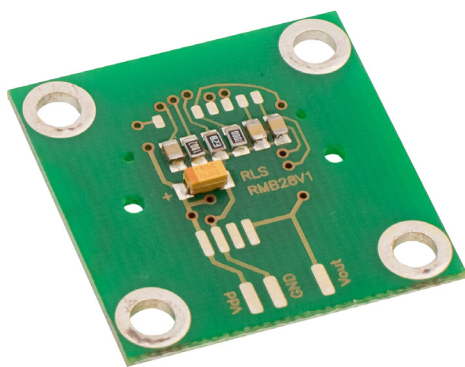

The images do not represent all variants.

The RMB28 encoder module is designed for direct integration into high volume OEM applications. The inexpensive 28 mm square PCB can also be supplied with a connector or as RMF44 on a metal flange with 44 mm diameter for easy mounting.

The encoder module consists of a magnetic actuator and a separate sensor board. The rotation of the magnetic actuator is detected and processed by a custom encoder chip mounted on the sensor board to obtain the desired output format. The output signals are provided in industry standard absolute, incremental, analog or linear voltage output formats.

The RMB28 and RMF44 encoder modules can be used in a wide range of OEM applications, including motor control and industrial automation.

Product range

RMB28AC / RMF44AC

Analogue sinusoidal output with a single sine/cosine period per revolution.

RMB28DC / RMF44DC

BiSS-C interface with up to 8,192 counts per revolution and optional revolution counter.

RMB28I / RMF44I

Incremental with up to 2,048 counts per revolution (320 to 8,192 counts per revolution with x4 evaluation).

RMB28MD / RMF44MD

Sine/Cosine + Absolute binary synchro-serial + Incremental, 5V.

RMB28SC / RMF44SC

Synchro serial interface (SSI) with up to 8,192 counts per revolution.

RMB28SI / RMF44SI

Synchro serial interface (SSI) and incremental outputs.

RMB28Vx / RMF44Vx

Linear voltage output in a range of variants.

- 28 mm square module with the option of 44 mm diameter metal flange
- Inexpensive solution for OEM integration
- 5 V and 24 V power supply versions
- High speed operation to 60,000 rpm
- Absolute - to 13 bit resolution (8,192 counts per revolution)
- Industry standard absolute, incremental, analogue, commutation and linear voltage output formats
- Accuracy to $\pm 0.5^\circ$
- RoHS compliant (lead free) - see Declaration of conformity

RMB28 installation drawing

Dimensions and tolerances in mm.

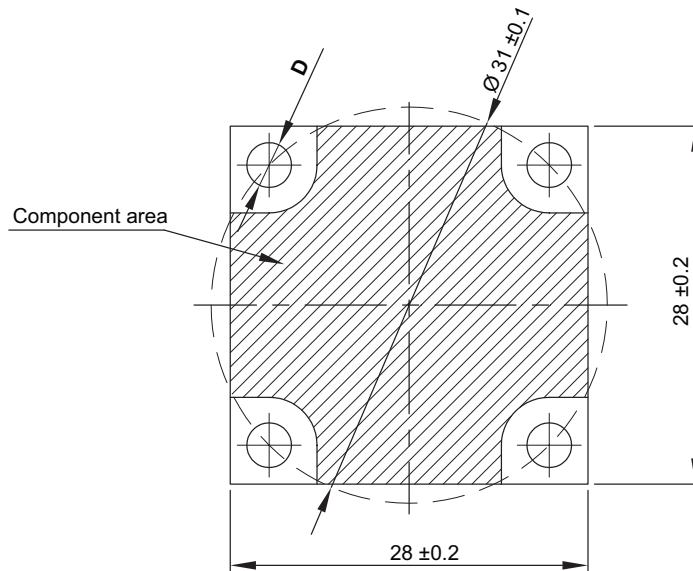
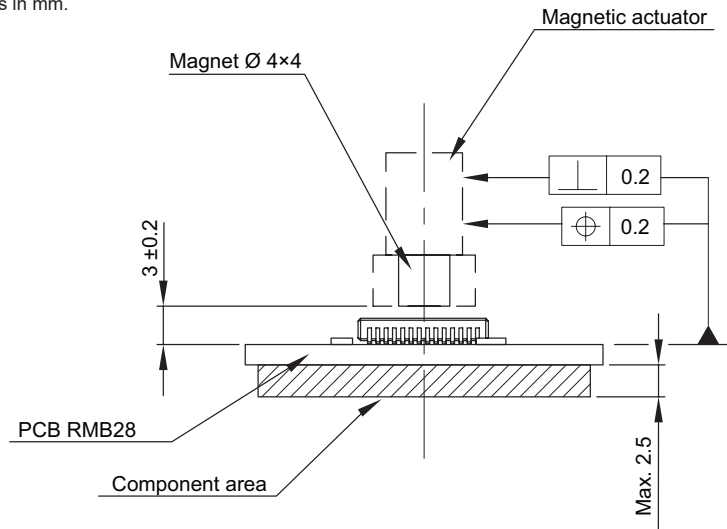

Output type	Hole diameter (D)
RMB28AC	2.5 ^{±0.1}
RMB28DC	2.5 ^{±0.1}
RMB28IC	2.5 ^{±0.1}
RMB28IB	3.5 ^{±0.1}
RMB28IE	3.5 ^{±0.1}
RMB28MD	3.5 ^{±0.1}
RMB28SC	2.5 ^{±0.1}
RMB28SI	2.5 ^{±0.1}
RMB28Vx	3.5 ^{±0.1}



Clockwise (CW) rotation of magnet

RMF44 installation drawing

Dimensions and tolerances in mm.

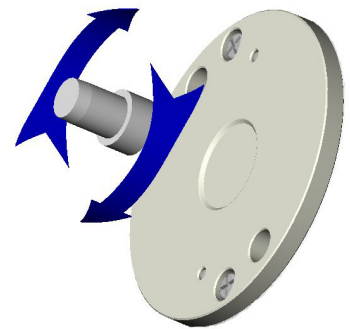
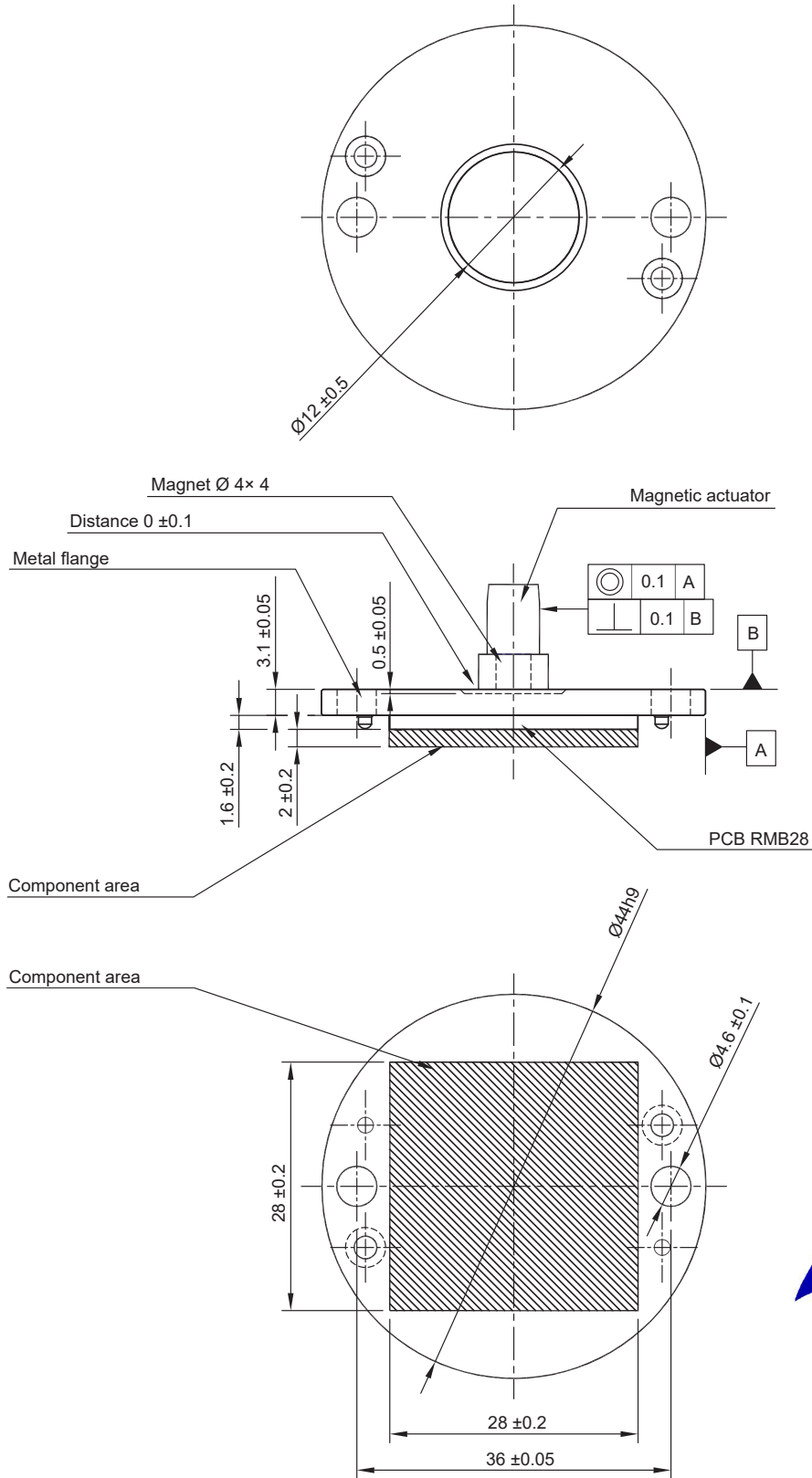

Clockwise (CW) rotation of magnet

RMB28AC / RMF44AC – Analogue sinusoidal

2 channels VA VB sinusoids (90° phase shifted, single ended)

Power supply	$V_{dd} = 5\text{ V} \pm 5\%$
Resolution	One sine/cosine wave per revolution
Current consumption	13 mA
Sin/Cos outputs	Signal amplitude: $1.1\text{ V} \pm 0.2\text{ V}$ Signal offset: $3/5 V_{dd} \pm 5\text{ mV}$
Maximum speed	60,000 rpm
Operating temperature	$-40\text{ }^\circ\text{C}$ to $+125\text{ }^\circ\text{C}$

Timing diagram

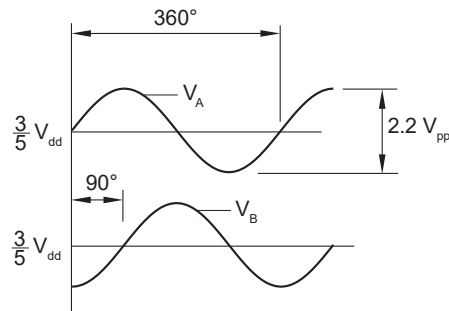

Connections

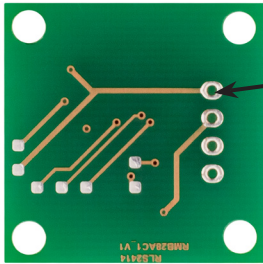

V_{dd}
GND
Cos
Sin

RMB28IE / RMF44IE – Incremental, Open Collector, NPN

Low cost alternative for ball bearing encoders

Power supply	$V_{dd} = 5\text{ V} \pm 5\%$
Current consumption	35 mA (not loaded)
Output signals	A, B, Z
Maximum output load	20 mA
Accuracy	Typ. $\pm 0.5^\circ$
Hysteresis	0.18°
Resolution	320, 400, 500, 512, 800, 1,000, 1,024, 1,600, 2,000, 2,048, 4,096, 8,192 counts per revolution
Maximum speed	30,000 rpm
Temperature	$-40\text{ }^\circ\text{C}$ to $+125\text{ }^\circ\text{C}$
Operating and storage	

Timing diagram

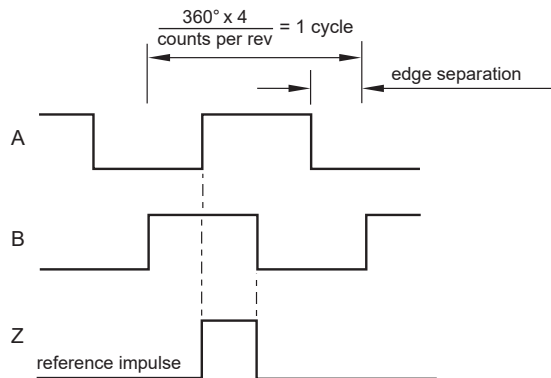

B leads A for clockwise rotation of magnet.

Connections

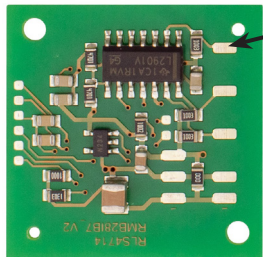

Z
A
B
GND
+5 V

Recommended signal termination

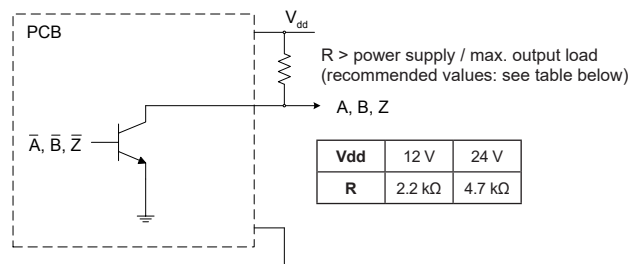

Vdd	12 V	24 V
R	2.2 kΩ	4.7 kΩ

RMB28IC / RMF44IC– Incremental, RS422

Square wave differential line driver to RS422

Power supply	$V_{dd} = 5\text{ V} \pm 5\%$
Current consumption	Max. 35 mA
Output signals	A, B, Z, A–, B–, Z– (RS422)
Accuracy	Typ. $\pm 0.5^\circ$
Hysteresis	0.18°
Resolution	320, 400, 500, 512, 800, 1,000, 1,024, 1,600, 2,000, 2,048, 4,096, 8,192 counts per revolution
Maximum speed	30,000 rpm
Temperature	-40°C to $+125^\circ\text{C}$
Operating and storage	-40°C to $+105^\circ\text{C}$ (with connector)

Connections

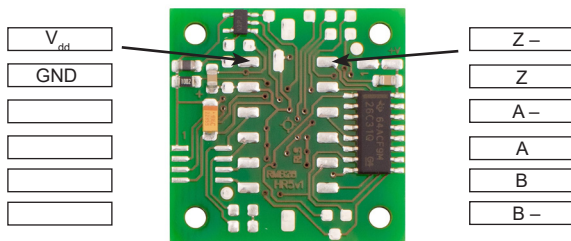

Connector type

Molex 43045-1219

Mating connector (Not provided)

Molex 43025-1200 (crimp terminal 43030-xxxx)

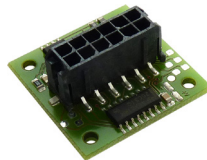

Timing diagram

Complementary signals not shown

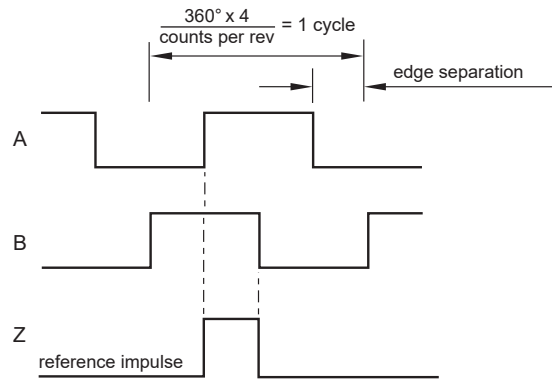

B leads A for clockwise rotation of magnet.

Recommended signal termination

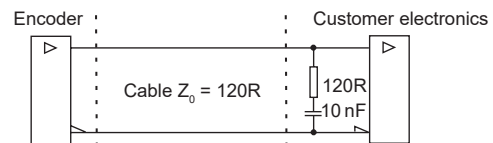

RMB28SC / RMF44SC – Absolute binary synchro-serial (SSI), RS422

Serial encoded absolute position measurement

Output code	Natural binary
Power supply	$V_{dd} = 5\text{ V} \pm 5\%$
Current consumption	Max. 35 mA
Data output	Serial data (RS422)
Data input	Clock (RS422)
Accuracy	Typ. $\pm 0.5^\circ$
Hysteresis	0.18°
Resolution	320, 400, 500, 512, 800, 1,000, 1,024, 1,600, 2,000, 2,048, 4,096, 8,192 counts per revolution
Maximum speed	30,000 rpm
Temperature	$-40\text{ }^\circ\text{C}$ to $+125\text{ }^\circ\text{C}$
Operating and storage	$-40\text{ }^\circ\text{C}$ to $+105\text{ }^\circ\text{C}$ (with connector)

Timing diagram

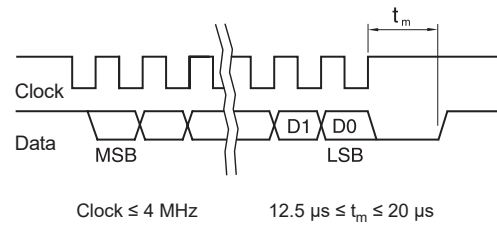

Position increases for clockwise rotation of magnet.

Recommended signal termination

For data output lines only

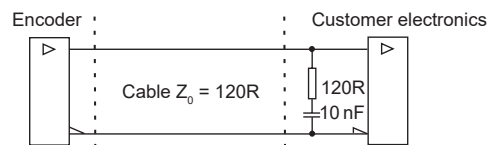

Connections

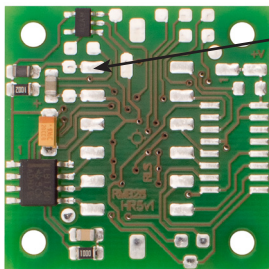

- V_{dd}
- GND
- Clock
- Clock -
- Data -
- Data

Connector type

Molex 43045-1219

Mating connector (Not provided)

Molex 43025-1200 (crimp terminal 43030-xxxx)

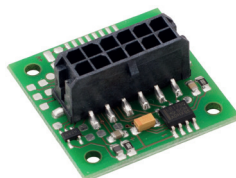

RMB28SI / RMF44SI – Absolute binary synchro-serial (SSI) + Incremental, RS422

Complex feedback device for absolute position at start up as well as during operation + incremental outputs.
Both the incremental and the SSI output always have the same fixed resolution.

Output code	Natural binary
Power supply	$V_{dd} = 5\text{ V} \pm 5\%$
Current consumption	Max. 35 mA
Incremental outputs	A, B, Z, A-, B-, Z- (RS422)
Data output	Serial data (RS422)
Data input	Clock (RS422)
Accuracy	Typ. $\pm 0.5^\circ$
Hysteresis	0.18°
Resolution	320, 400, 500, 512, 800, 1,000, 1,024, 1,600, 2,000, 2,048, 4,096, 8,192 counts per revolution
Maximum speed	30,000 rpm
Temperature	-40°C to $+125^\circ\text{C}$
Operating and storage	-40°C to $+105^\circ\text{C}$ (with connector)

Connections

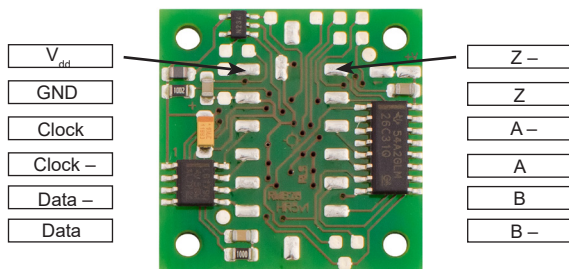

Connector type

Molex 43045-1219

Mating connector (Not provided)

Molex 43025-1200 (crimp terminal 43030-xxxx)

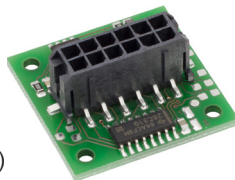

Timing diagram - SSI

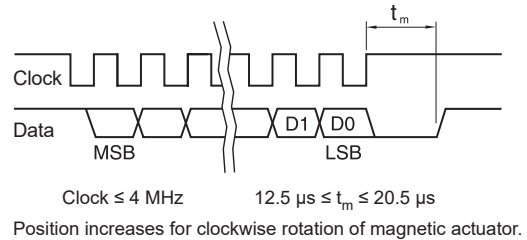

Timing diagram - Incremental

Complementary signals not shown

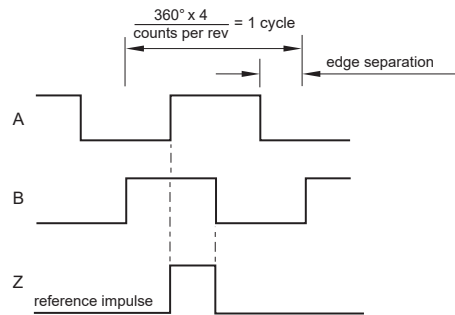

B leads A for clockwise rotation of magnetic actuator.

Recommended signal termination

For incremental signals + SSI data output lines only

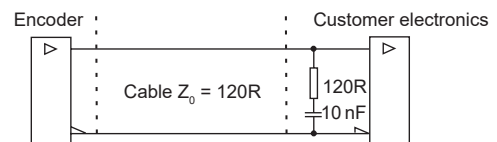

RMB28DC / RMF44DC – Absolute encoder with BiSS-C interface

Serial encoded absolute position measurement

Output code	Natural binary
Power supply	$V_{dd} = 5\text{ V} \pm 5\%$
Current consumption	Max. 50 mA
Clock input	MA (RS422)
Data output	SLO (RS422)
Accuracy	Typ. $\pm 0.5^\circ$
Hysteresis	0.18°
Resolution	320, 400, 500, 512, 800, 1,000, 1,024, 1,600, 2,000, 2,048, 4,096, 8,192 positions per revolution
Revolution counter	12 bit (4096 revolutions)
Maximum speed	30,000 rpm
Operating temperature	$-40\text{ }^\circ\text{C}$ to $+125\text{ }^\circ\text{C}$ $-40\text{ }^\circ\text{C}$ to $+105\text{ }^\circ\text{C}$ (with connector)
Max MA frequency	8 MHz

Recommended signal termination

For data output lines only

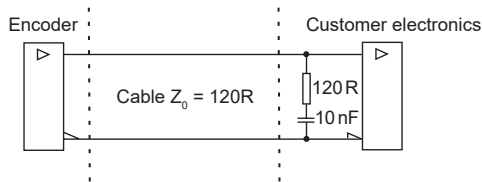

Timing diagram – BiSS C

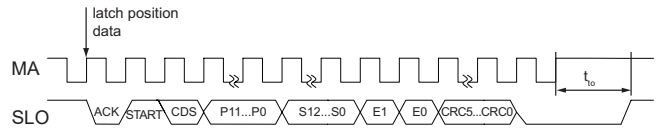

Data	Length	Description
P11 – P0	0 or 12 bit	Revolution counter value when enabled (see Part numbering/ resolution)
S12 – S0	7 to 13 bit	Position inside the revolution (length depends on the resolution)
E1 – E0	2 bit	Error data
CRC5 – CRC0	5 to 6 bit	Cyclic redundancy check data; polynomial 0x43; inverted bit output

Error	E0	E1
No error	1	1
Amplitude error	0	1
Too high velocity	1	0
Undervoltage; Configuration; System error	0	0

* The revolution counter counts the number of mechanical revolutions of the shaft or magnet of the encoder. Counting is possible only when the encoder is powered. When the encoder is powered off, the revolution counter is reset to 0.

For more information on BiSS C protocol please visit www.biss-interface.com.

Connections

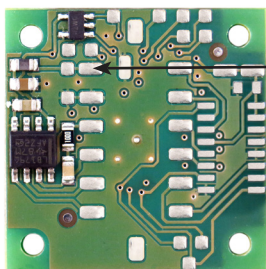

V_{dd}
GND
MA+
MA-
SLO -
SLO+

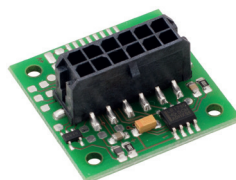

Connector type

Molex 43045-1219

Mating connector (Not provided)

Molex 43025-1200 (crimp terminal 43030-xxxx)

RMB28MD / RMF44MD – Sine/Cosine + Absolute binary synchro-serial (SSI) + Incremental

Complex feedback device for absolute position at start-up as well as during operation + incremental outputs

Output code	Natural binary
Power supply	$V_{dd} = 5\text{ V} \pm 5\%$
Current consumption	13 mA – incremental and SSI (not loaded)
Incremental outputs	A, B, Z
Sin/Cos outputs	Signal amplitude: $1.1\text{ V} \pm 0.2\text{ V}$ Signal offset: $V_{dd}/2 \pm 5\text{ mV}$
Data output	Serial data
Data input	Clock
Accuracy	$\pm 0.7^\circ$
Hysteresis	0.45°
Resolution	8 bit + 64 ppr (256 cpr) + one sine/ cosine period per revolution
Maximum speed	60,000 rpm
Temperature	-40°C to $+125^\circ\text{C}$
Operating and storage	

Connections

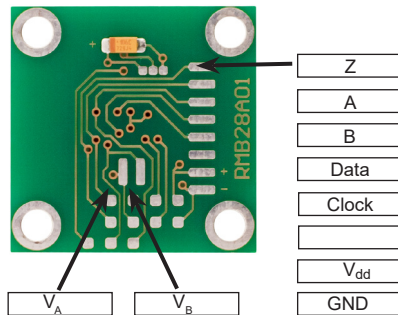

Timing diagram - SSI

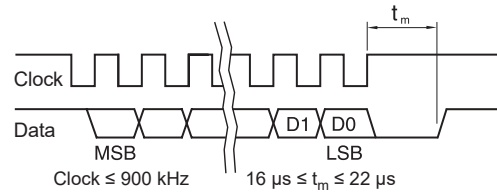

Position increases for clockwise rotation of magnet.

Timing diagram - Incremental

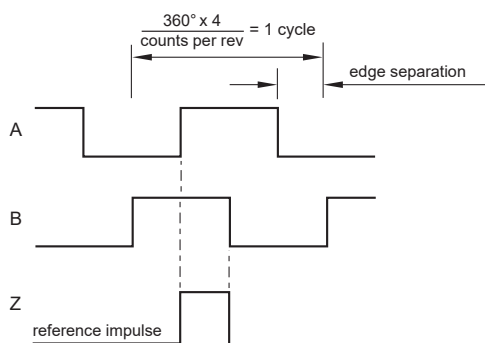

B leads A for clockwise rotation of magnet.

Timing diagram - Sine/Cosine

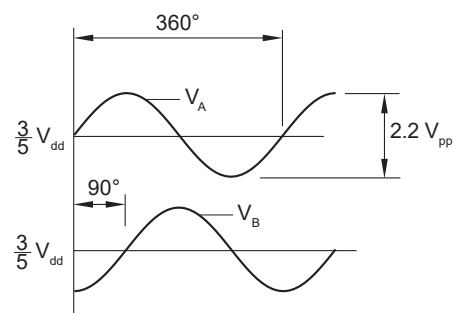

RMB28Vx / RMF44Vx – Linear voltage output

Alternative for potentiometers

Power supply	$V_{dd} = 5\text{ V} \pm 5\%$
Current consumption	Typ. 26 mA
Output voltage	0 V to V_{dd}
Output loading	Max. 2 mA
Nonlinearity	1 %
Resolution of DAC	10 bit
Maximum speed	30,000 rpm
Temperature	-40 °C to +125 °C
Operating and storage	

Connections

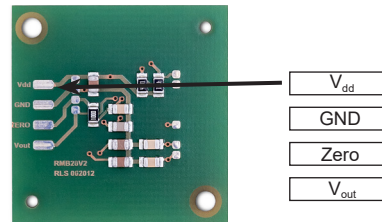

The digital relative angular position information is converted into linear voltage with a built-in 10 bit D/A converter. The linear output voltage swing ranges from 0 V and V_{dd} (5 V). The number of periods within one revolution (N_{period}) can be 1, 2, 4 or 8, representing one full swing over an angle (φ_{period}) of 360°, 180°, 90° or 45° respectively. The signal is made up of steps which represent the angular movement needed to register a change in the position (φ_{step}) and the resulting change in the output voltage (V_{step}). The number of steps in one period (N_{step}) is given in the table below.

For clockwise rotation of the magnetic actuator, the output voltage increases. For counterclockwise rotation, the output voltage decreases.

Timing diagram for linear voltage output

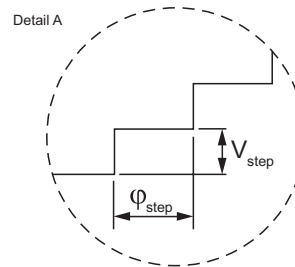
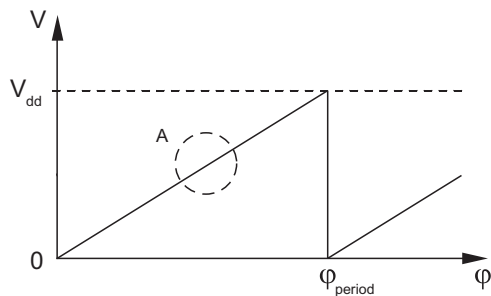

$$\varphi_{\text{step}} = \frac{\varphi_{\text{period}}}{N_{\text{step}}} \quad V_{\text{step}} = \frac{V_{\text{dd}}}{N_{\text{step}}}$$

φ_{period} = Angle covered in one period (one sawtooth)

V_{period} = Output voltage range for one period

φ_{step} = Step angle (angular movement needed to register a change in the position)

V_{step} = Output voltage range for one step

N_{period} = Number of periods in one revolution

N_{step} = Number of steps in one period

φ_{period}	N_{period}	N_{step}	φ_{step}
360°	1	1024	0.35°
180°	2	1024	0.18°
90°	4	1024	0.09°
45°	8	512	0.09°

Output type and electrical variant

φ_{period}	360°	180°	90°	45°
Rotation				
Clockwise	VA	VB	VC	VD
Counterclockwise	VE	VF	VG	VH

RMB281B / RMF441B – Incremental, Open Collector, NPN

Square wave output

Power supply	$V_{dd} = 8\text{ V to }26\text{ V}$
Current consumption	50 mA
Output signals	A, B, Z
Maximum output load	20 mA
Accuracy	Typ. $\pm 0.5^\circ$
Hysteresis	0.18°
Resolution	80 to 2,048 pulses per revolution (320, 400, 500, 512, 800, 1,000, 1,024, 1,600, 2,000, 2,048, 4,096, 8,192 counts per revolution)
Maximum speed	30,000 rpm
Temperature Operating and storage	$-40\text{ }^\circ\text{C to }+125\text{ }^\circ\text{C}$

Timing diagram

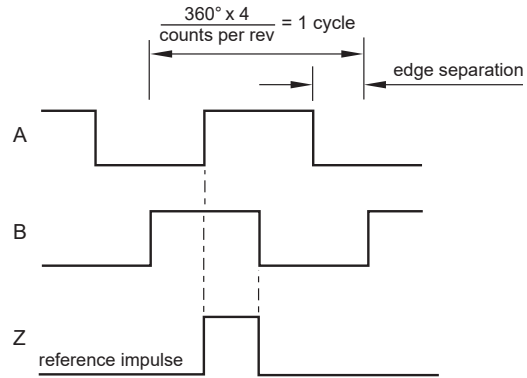

B leads A for clockwise rotation of magnet.

Connections

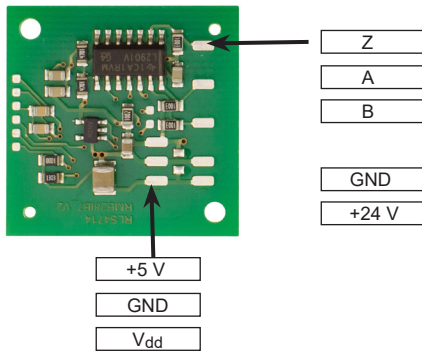

Recommended signal termination

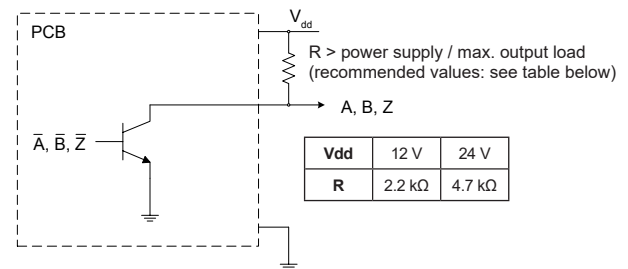

NOTE: RMB281B / RMF441B boards need 2 power supplies; pad V_{dd} needs 24 V and pad +5 V needs 5 V. Pads V_{in}, GND and +5 V have been provided to allow easy connection to a 3 terminal voltage regulator to generate 5 V from 24 V.

Part numbering

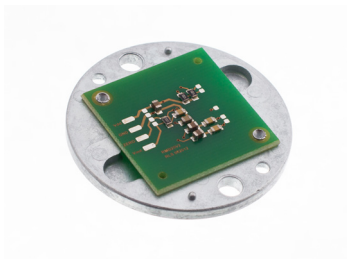
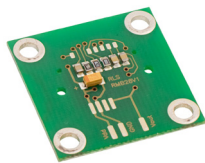

RMF44 IC 08B A 10

Series

RMB28

RMF44 - RMB28 encoder module on 44 mm diameter metal flange

Output type

AC - Analogue sinusoidal, 5 V

DC - BiSS, RS422, 5 V

IB - Incremental, open collector, NPN, 24 V

IC - Incremental, RS422, 5 V

IE - Incremental, open collector, NPN, 5 V

MD - SSI + Incremental + Analogue sinusoidal, 5 V

SC - Absolute binary synchro-serial (SSI), RS422, 5 V

SI - SSI + Incremental, RS422, 5 V

Vx - Linear voltage

Linear voltage output 0 - 5 V, supply 5 V DC				
	360°	180°	90°	45°
CW	VA	VB	VC	VD
CCW	VE	VF	VG	VH

NOTE: Not all combinations are valid.

Special requirements

10 - No special requirements (standard)

11 - With Molex connector (for **IC**, **SC** and **SI**)

Shape

S - Square (for RMB28)

A - Standard 44 mm diameter aluminium flange (for RMF44)

Resolution

For **AC**:

01S - One sine/cosine wave per revolution

For **MD**:

08B - 256 counts or positions per revolution

For **DC**, **IB**, **IC**, **IE**, **SC** and **SI** (counts/positions per revolution):

Decimal			Binary		
D32 - 320	D80 - 800	2D0 - 2000	07B - 128	10B - 1024	13B - 8192
D40 - 400	1D0 - 1000		08B - 256	11B - 2048	
D50 - 500	1D6 - 1600		09B - 512	12B - 4096	

For output types **DC** with enabled 12 bit revolution counter:

Decimal			Binary		
M32 - 320	M80 - 800	2M0 - 2000	07M - 128	10M - 1024	13M - 8192
M40 - 400	1M0 - 1000		08M - 256	11M - 2048	
M50 - 500	1M6 - 1600		09M - 512	12M - 4096	

For **Vx**:

10B - 1,024 steps per revolution

* For sample quantities of RMB28 supplied with a magnet please add "KIT" to the end of the required RMB28 part number, eg. RMB28IC09BS10KIT.

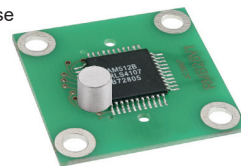

Series	Output type	Resolution	Shape	Special requirements
RMB28 / RMF44	AC	01S	S / A	10
	MD	08B		
	Vx	10B		
	IB	2D0 / 1D6 / 1D0 / D80 / D50 / D40 / D32 / 12B / 13B / 11B / 10B / 09B / 08B / 07B		10 / 11
	IE			
	IC			
	SC			
	SI			
DC	09B / D50 / D40 / D32 / 10B / 1D0 / D80 / 11B / 2D0 / 1D6 / 12B / 13B / 09M / M50 / M40 / M32 / 10M / 1M0 / M80 / 11M / 2M0 / 1M6 / 12M / 13M			

Magnetic actuator and magnet ordering information

Dimensions and tolerances in mm.

Actuator for integration onto shaft



Shaft = \varnothing^*h7
Fixing: Grub screw provided

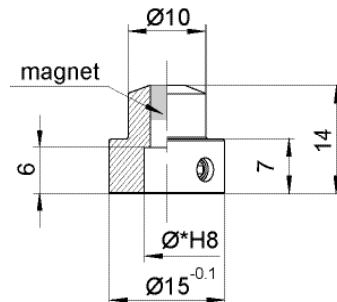

Part numbers:

For resolutions up to 9 bit absolute (512 cpr incremental)
RMA04A2A00 – $\varnothing 4$ mm shaft **RMA10A2A00** – $\varnothing 10$ mm shaft
RMA05A2A00 – $\varnothing 5$ mm shaft **RMA19A2A00** – $\varnothing 3/16$ " shaft
RMA06A2A00 – $\varnothing 6$ mm shaft **RMA25A2A00** – $\varnothing 1/4$ " shaft
RMA08A2A00 – $\varnothing 8$ mm shaft **RMA37A2A00** – $\varnothing 3/8$ " shaft

For resolutions from 10 bit absolute (800 cpr incremental) and above
RMA04A3A00 – $\varnothing 4$ mm shaft **RMA10A3A00** – $\varnothing 10$ mm shaft
RMA05A3A00 – $\varnothing 5$ mm shaft **RMA19A3A00** – $\varnothing 3/16$ " shaft
RMA06A3A00 – $\varnothing 6$ mm shaft **RMA25A3A00** – $\varnothing 1/4$ " shaft
RMA08A3A00 – $\varnothing 8$ mm shaft **RMA37A3A00** – $\varnothing 3/8$ " shaft

Actuator for integration into shaft

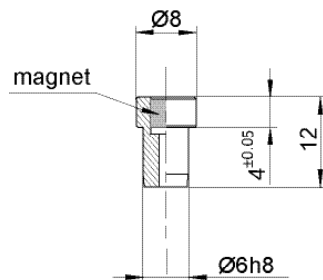

Part numbers:

For resolutions up to 9 bit absolute (512 cpr incremental)
RMH06A2A00

For resolutions from 10 bit absolute (800 cpr incremental) and above
RMH06A3A00

With N-pole marker scribed to a $\pm 5^\circ$ accuracy:

For resolutions up to 9 bit absolute (512 cpr incremental)
RMH06A2A02

For resolutions from 10 bit absolute (800 cpr incremental) and above
RMH06A3A02

Hole = $\varnothing 6G7$

Fixing: Glue (recommended – LOCTITE 648 or LOCTITE 2701)

Magnet for direct recessing in non-ferrous shafts

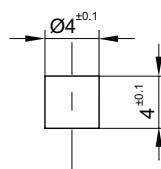

Fixing: Glue (recommended – LOCTITE 648 or LOCTITE 2701)

Part numbers:

For resolutions up to 9 bit absolute (512 cpr incremental)
RMM44A2A00 (individually packed) – for sample quantities only
RMM44A2C00 (packed in tubes)

For resolutions from 10 bit absolute (800 cpr incremental) and above
RMM44A3A00 (individually packed) – for sample quantities only
RMM44A3C00 (packed in tubes)

Head office

RLS Merilna tehnika d. o. o.
 Poslovna cona Žeje pri Komendi
 Pod vrbami 2
 SI-1218 Komenda
 Slovenia

T +386 1 5272100

E mail@rls.si

www.rls.si

Document issues

Issue	Date	Page	Amendments done
9	8. 3. 2017	General	RMF44 added
10	1. 2. 2018	3	RMF44 installation drawing amended
11	18. 5. 2018	3	RMF44 installation drawing amended
		4 - 6, 8, 9	Resolutions amended
12	27. 7. 2018	General	Resolution amended
13	17. 9. 2018	3	RMF44 installation drawing amended
14	29. 8. 2019	3	RMF44 installation drawing amended
15	19. 12. 2019	4, 10	Signal termination amended
16	13. 5. 2020	4	Recommended signal termination for RMB28IE / RMF44IE amended
		2, 8, 12	RMB28DC / RMF44DC added
17	30. 11. 2021	3	Drawing amended
18	10. 5. 2022	4	RMB28AC SinCos output amended
19	19. 1. 2023	General	Revolution counter added

This product is not designed or intended for use outside the environmental limitations and operating parameters expressly stated on the product's datasheet. Products are not designed or intended for use in medical, military, aerospace, automotive or oil & gas applications or any safety-critical applications where a failure of the product could cause severe environmental or property damage, personal injury or death. Any use in such applications must be specifically agreed to by seller in writing, and is subject to such additional terms as the seller may impose in its sole discretion. Use of products in such applications is at buyer's own risk, and buyer will indemnify and hold harmless seller and its affiliates against any liability, loss, damage or expense arising from such use. Information contained in this datasheet was derived from product testing under controlled laboratory conditions and data reported thereon is subject to the stated tolerances and variations, or if none are stated, then to tolerances and variations consistent with usual trade practices and testing methods. The product's performance outside of laboratory conditions, including when one or more operating parameters is at its maximum range, may not conform to the product's datasheet. Further, information in the product's datasheet does not reflect the performance of the product in any application, end-use or operating environment buyer or its customer may put the product to. Seller and its affiliates make no recommendation, warranty or representation as to the suitability of the product for buyer's application, use, end-product, process or combination with any other product or as to any results buyer or its customer might obtain in their use of the product. Buyer should use its own knowledge, judgment, expertise and testing in selecting the product for buyer's application, end-use and/or operating environment, and should not rely on any oral or written statement, representation, or samples made by seller or its affiliates for any purpose. EXCEPT FOR THE WARRANTIES EXPRESSLY SET FORTH IN THE SELLER'S TERMS AND CONDITIONS OF SALE, SELLER MAKES NO WARRANTY EXPRESS OR IMPLIED WITH RESPECT TO THE PRODUCT, INCLUDING ANY WARRANTY OF MERCHANTABILITY OR FITNESS FOR ANY PARTICULAR PURPOSE, WHICH ARE DISCLAIMED AND EXCLUDED. All sales are subject to seller's exclusive terms and conditions of sale which, where the seller is (a) RLS Merilna tehnika d. o. o., are available at <https://www.rls.si/customer-service>, (b) Renishaw, Inc., are available at <http://www.renishaw.com/Shop/legal/en/-42186>, or (c) another person, are available on request, and in each case, are incorporated herein by reference, and are the exclusive terms of sale. No other terms and conditions apply. Buyer is not authorized to make any statements or representations that expand upon or extend the environmental limitations and operating parameters of the products, or which imply permitted usage outside of that expressly stated on the datasheet or agreed to in writing by seller.

RLS Merilna tehnika d. o. o. has made considerable effort to ensure the content of this document is correct at the date of publication but makes no warranties or representations regarding the content. RLS Merilna tehnika d. o. o. excludes liability, howsoever arising, for any inaccuracies in this document. © 2023 RLS d. o. o.