

RE36 rotary magnetic shaft encoders



The RE36 is a high-speed rotary magnetic encoder designed for use in harsh environments. The traditional design enables easy integration on existing machines.

A magnet is mounted to the shaft within the encoder's body. Rotation of this magnet is sensed by a custom encoder chip within the body, and processed to give the required output format.

The encoder chip processes the signals received to provide resolutions to 13 bit (8,192 positions per revolution) with high operational speeds. Resolution options include binary and decimal. Output signals are provided in industry standard absolute, incremental or analogue formats.

The compact encoder body is 36 mm in diameter and provides dirt immunity up to IP53.

The RE36 can be used in a wide range of applications including marine, medical, print, converting, industrial automation, metal working and instrumentation.

Product range

5 V power supply version

RE361C

Incremental with 80 to 2,048 pulses per revolution (320 to 8,192 counts per revolution with x 4 evaluation).

RE36S

Synchro serial interface (SSI with 320 to 8,192 positions per revolution).

24 V power supply version

RE36I

Incremental with 80 to 2,048 pulses per revolution (320 to 8,192 counts per revolution with x 4 evaluation)

RE36Vx

Linear voltage output in a range of variants.

RE36Cx

Linear current output in a range of variants.

- High speed operation to 20,000 rpm
- 36 mm diameter body
- Industry standard absolute, incremental and linear output formats
- Binary and decimal resolution options
- Accuracy to $\pm 0.3^\circ$
- Simple integration
- Low inertia

Storage and handling

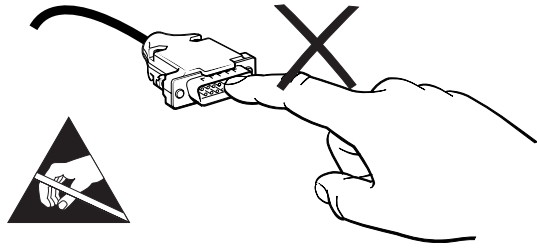

IMPORTANT: Power to RE36 encoders must be supplied from a DC SELV supply complying with the essential requirements of EN (IEC) 60950 or similar specification.

The RE36 series encoders have been designed to the relevant EMC standards, but must be correctly integrated to achieve EMC compliance. In particular, attention to shielding arrangements is critical.

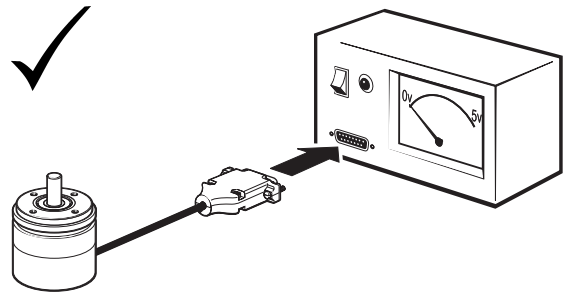
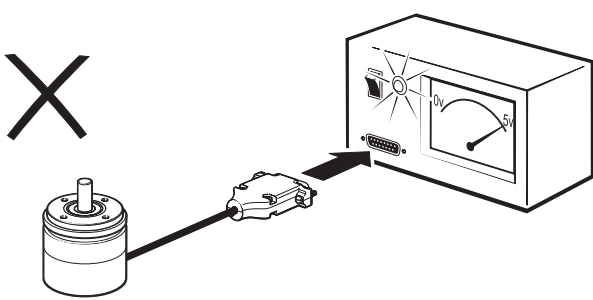

Connections

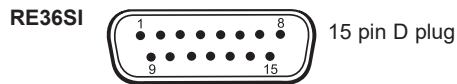
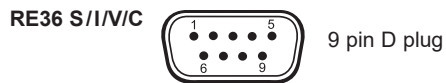
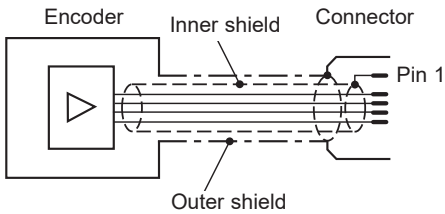

Pin nr.	RE36SC		RE36I		RE36Vx		RE36Cx		RE36SI	
	Function	Wire colour	Function	Wire colour	Function	Wire colour	Function	Wire colour	Function	Wire colour
1	Shield - see connection diagram		Shield - see connection diagram		Shield - see connection diagram		Shield - see connection diagram			
2	Clock+	White	Z+	White	NC	-	NC	-	A+	Grey
3	Clock-	Brown	B+	Green	V _{OUT}	Green	I _{OUT}	Green	A-	Pink
4	NC	-	A+	Grey	NC	-	NC	-	B+	Green
5	V _{dd}	Red	V _{dd}	Red	V _{dd} ¹	Red	V _{dd}	Red	B-	Yellow
6	Data+	Green	¹ Z-	Brown	² V _{dd} -	Brown	NC	-	Z+	White
7	Data-	Yellow	¹ B-	Yellow	NC	-	NC	-	Z-	Brown
8	NC	-	¹ A-	Pink	NC	-	NC	-	V _{dd}	Res
9	GND	Blue	GND	Blue	0V	Blue	0V	Blue	Clock+	Black
10									Clock-	Violet
11									NC	-
12									Data+	Orange
13									Data-	Clear
14									NC	-
15									GND	Blue

¹ Not available for IB variant

² For variants VM, VN, VP, VQ, VR, VS, VT, and VV only

Installation drawing

Dimensions and tolerances in mm

IP53

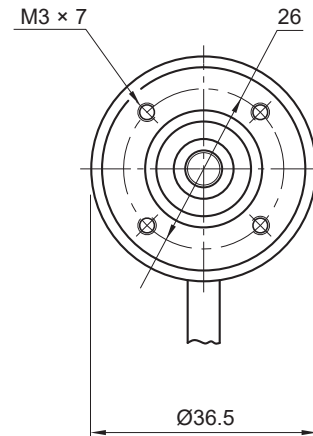
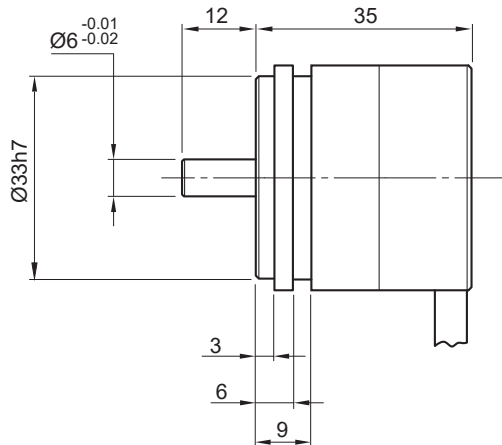

Table of expected bearing life ratings in hours

Speed (rpm)	Rad. load 15 N	Rad. load 20 N	Rad. load 25 N	Rad. load 30 N
500	296,282	227,542	178,523	142,631
1,000	148,142	113,767	89,267	71,317
2,000	74,071	56,883	44,633	35,658
5,000	29,628	22,753	17,853	14,263
10,000	14,814	11,377	8,927	7,131
15,000	9,876	7,584	5,951	4,754
20,000	7,407	5,688	4,463	3,566

Maximum recommended shaft loads: radial 30N, axial 15N

Special option 06

Flat, D-shaped shaft

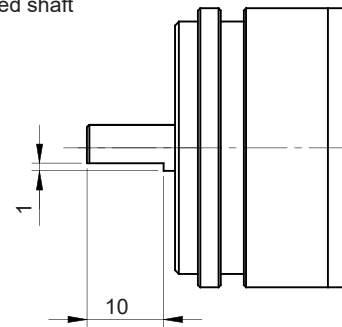

Operating and electrical specifications

Humidity (for IP64 version)	Storage 95 % maximum relative humidity (non-condensing) (IEC 61010-1) Operating 80 % maximum relative humidity (non-condensing) (IEC 61010-1)
Acceleration	Operating 500 m/s ² EN 60068-2-7:1993 (IEC 68-2-7:1983)
Shock (non-operating)	1000 m/s ² , 6 ms, 1/2 sine EN 60068-2-27:1993 (IEC 68-2-27:1987)
Vibration (operating)	100 m/s ² max at 55 to 2000 Hz EN 60068-2-6:1996 (IEC 68-2-6:1995)
EMC compliance	EN 61326
Cable	Outside diameter 5 mm, >R40 static bend radius
Mass	Encoder unit 1 m cable (no connector) IP53 side cable 105 g.
Environmental sealing	IP53

Output specifications - 5 V supply

RE36IC – Incremental outputs

Square wave differential line driver to RS422

Power supply	$V_{dd} = 5\text{ V} \pm 5\%$
Power consumption	Max. 35 mA
Output signals	A, B, Z, A-, B-, Z- (RS422)
Accuracy	Typ. $\pm 0.5^\circ$
Hysteresis	0.18°
Resolution	80 to 2,048 pulses per revolution (320, 400, 500, 512, 800, 1,000, 1,024, 1,600, 2,000, 2,048, 4,096, 8,192 counts per revolution)
Maximum speed	20,000 rpm
Maximum cable length	50 m
Operating and storage temperature	$-40\text{ }^\circ\text{C}$ to $+120\text{ }^\circ\text{C}$

Timing diagram

Complementary signals not shown

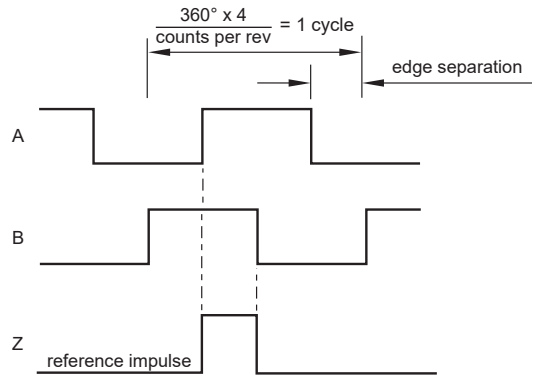

B leads A for clockwise rotation of magnetic actuator.

Recommended signal termination

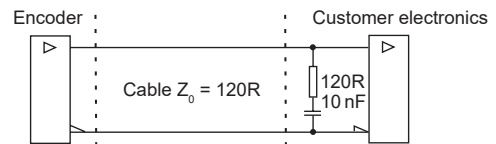

RE36SC – Absolute binary synchro-serial interface (SSI)

Serial encoded absolute position measurement

Output code	Natural binary
Power supply	$V_{dd} = 5\text{ V} \pm 5\%$
Power consumption	Max. 35 mA
Data output	Serial data (RS422)
Data input	Clock (RS422)
Accuracy	Typ. $\pm 0.5^\circ$
Hysteresis	0.18°
Resolution	320, 400, 500, 512, 800, 1,000, 1,024, 1,600, 2,000, 2,048, 4,096, 8,192 positions per revolution
Maximum speed	20,000 rpm
Maximum cable length	100 m (at 1 MHz)
Operating and storage temperature	$-40\text{ }^\circ\text{C}$ to $+120\text{ }^\circ\text{C}$

Timing diagram

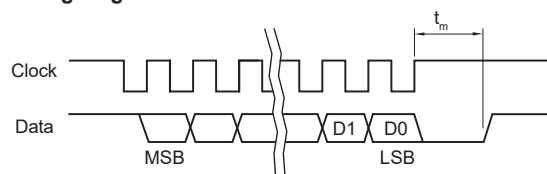

Clock $\leq 4\text{ MHz}$ $12.5\text{ }\mu\text{s} \leq t_m \leq 20.5\text{ }\mu\text{s}$

Position increases for clockwise rotation of magnetic actuator.

Recommended signal termination

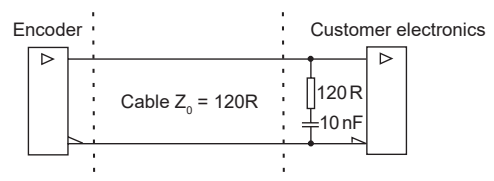

RE36SI – Absolute binary synchro-serial interface (SSI) + Incremental, RS422

Complex feedback device for absolute position at start up as well as during operation + incremental outputs.

Both the incremental and the SSI output always have the same fixed resolution.

Output code	Natural binary
Power supply	$V_{dd} = 5\text{ V} \pm 5\%$
Power consumption	Max. 35 mA
Incremental outputs	A, B, Z, A-, B-, Z- (RS422)
Data output	Serial data (RS422)
Data input	Clock (RS422)
Accuracy	Typ. $\pm 0.5^\circ$
Hysteresis	0.18°
Resolution	80 to 2,048 pulses per revolution (320, 400, 500, 512, 800, 1,000, 1,024, 1,600, 2,000, 2,048, 4,096, 8,192 counts per revolution)
Maximum speed	20,000 rpm
Maximum cable length	100 m (at 1 MHz)
Operating and storage temperature	-40°C to $+120^\circ\text{C}$

Recommended signal termination

For incremental signals + SSI data output lines only

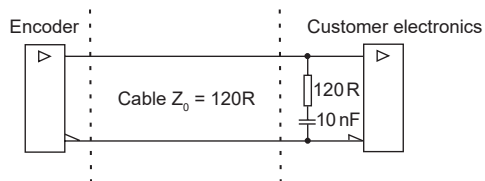

Timing diagram - SSI

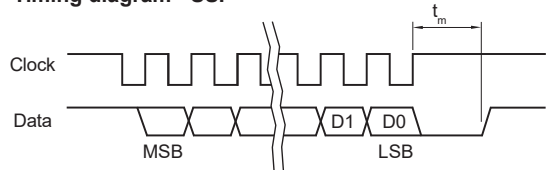

$$\text{Clock} \leq 4\text{ MHz} \quad 12.5\ \mu\text{s} \leq t_m \leq 20.5\ \mu\text{s}$$

Position increases for clockwise rotation of magnetic actuator.

Timing diagram - Incremental

Complementary signals not shown

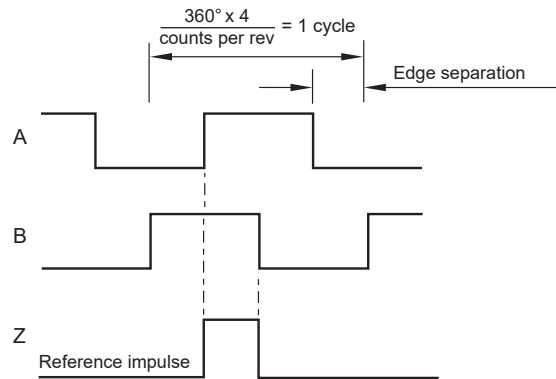

B leads A for clockwise rotation of magnetic actuator.

Output specifications - 24 V supply

RE36IA – Incremental, push-pull

Power supply	$V_{dd} = 8\text{ V to }26\text{ V}$
Power consumption	50 mA
Output signals	A, B, Z, A-, B-, Z- (RS422)
Maximum output load	30 mA
Accuracy	Typ. $\pm 0.5^\circ$
Hysteresis	0.18°
Resolution	80 to 2,048 pulses per revolution (320, 400, 500, 512, 800, 1,000, 1,024, 1,600, 2,000, 2,048, 4,096, 8,192 counts per revolution)
Maximum speed	20,000 rpm
Maximum cable length	20 m
Operating and storage temperature	-40 °C to +120 °C

Timing diagram

Complementary signals not shown

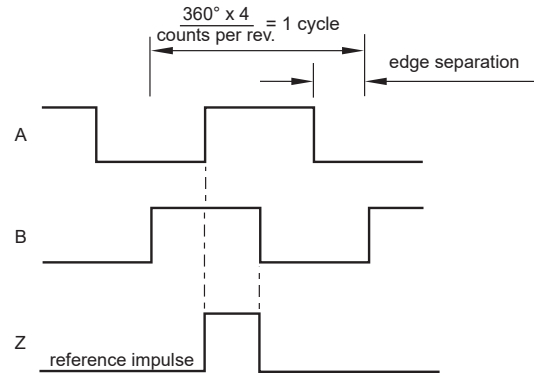

B leads A for clockwise rotation of magnetic actuator.

RE36IB – Incremental, open collector NPN

Square wave output

Power supply	$V_{dd} = 8\text{ V to }26\text{ V}$
Power consumption	50 mA
Output signals	A, B, Z
Maximum output load	20 mA
Accuracy	Typ. $\pm 0.5^\circ$
Hysteresis	0.18°
Resolution	80 to 2,048 pulses per revolution (320, 400, 500, 512, 800, 1,000, 1,024, 1,600, 2,000, 2,048, 4,096, 8,192 counts per revolution)
Maximum speed	20,000 rpm
Maximum cable length	20 m
Operating and storage temperature	-40 °C to +120 °C

Timing diagram

Complementary signals not shown

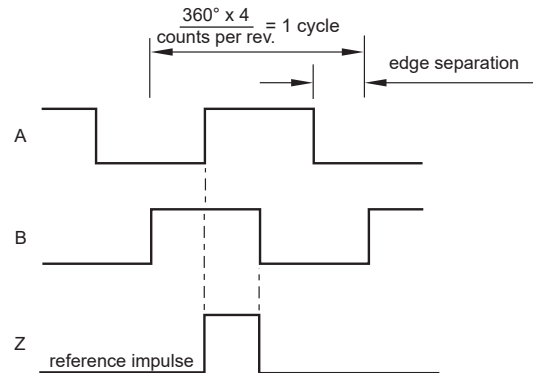

B leads A for clockwise rotation of magnetic actuator.

Recommended signal termination

For data output lines only

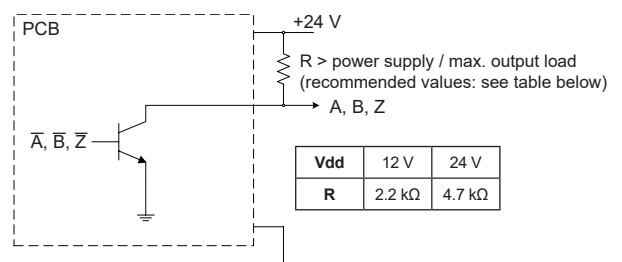

RE36Vx – Linear voltage output

Power supply	Type I: +20 V to +30 V DC Type II: ± 12 V to ± 16 V DC
Power consumption	Typ. 40 mA
Output voltage	Type I: 0 V to 10 V DC Type II: -10 V to +10 V DC
Output loading	Max. 10 mA
Nonlinearity	1 %
Maximum speed	20,000 rpm
Max. cable length	20 m
Operating and storage temperature	-25 °C to +85 °C

Electrical output/shaft position

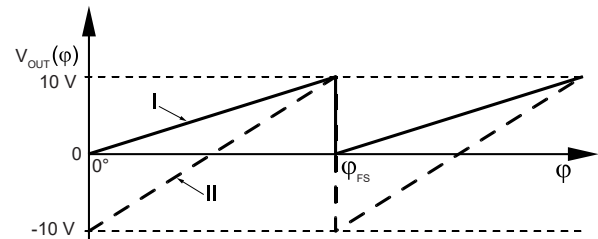

Position increases for clockwise rotation of magnetic actuator.

Output type and electrical variant

ϕ_{FS}	Type I				Type II			
	360°	180°	90°	45°	360°	180°	90°	45°
Clockwise	VA	VB	VC	VD	VM	VN	VP	VQ
Counterclockwise	VE	VF	VG	VH	VR	VS	VT	VV

RE36Cx - Linear current output

Power supply	$V_{dd} = +20$ V to +30 V DC
Power consumption	50 mA plus output current
Output current	4 mA to 20 mA
Output loading	$R_L = 0$ to $\frac{V_{dd}}{I_{OUTmax}}$
Nonlinearity	1 %
Maximum speed	20,000 rpm
Maximum cable length	20 m
Operating and storage temperature	-25 °C to +85 °C

Electrical output/shaft position

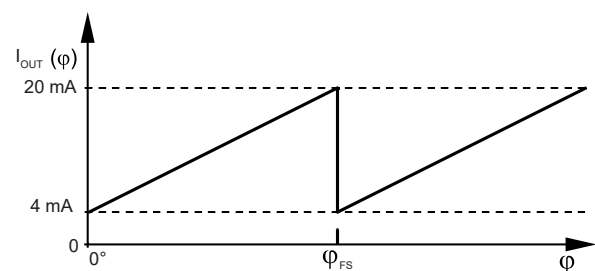

Position increases for clockwise rotation of magnetic actuator.

Output type and electrical variant

ϕ_{FS}	360°	180°	90°	45°
Clockwise	CA	CB	CC	CD
Counterclockwise	CE	CF	CG	CH

Part numbering



Encoder part number
eg RE36SC0612B10A2A00

RE36 SC 06 12B 10 A 2 A 00

Output type

- IA - Incremental, push-pull, 24 V
- IB - Incremental, open collector, 24 V
- IC - Incremental, RS422, 5 V
- SC - Absolute binary synchro-serial (SSI), RS422, 5 V
- SI - SSI and incremental, RS422, 5 V
- Cx - Linear current:

Linear current output 4 mA to 20 mA, supply +20 V to +30 V DC				
	360°	180°	90°	45°
Clockwise	CA	CB	CC	CD
Counter clockwise	CE	CF	CG	CH

Vx - Linear voltage:

Linear voltage output 0 V to 10 V, supply +20 V to +30 V DC				
	360°	180°	90°	45°
Clockwise	VA	VB	VC	VD
Counter clockwise	VE	VF	VG	VH

Linear voltage output ±10 V, supply ±12 V to ±16 V DC				
	360°	180°	90°	45°
Clockwise	VM	VN	VP	VQ
Counter clockwise	VR	VS	VT	VV

Shaft size
06 - 6 mm

Special requirements

- 00 - None
- 06 - With flat, D-shaped shaft
- 0M - Cable length in meters
- 6M - With flat, D-shaped shaft, cable length in meters

Environment and material

- A - IP53, aluminium body (standard)

Body style and cable exit

- 2 - Cylindrical body, radial cable exit

Connector option

- A - 'D' type connector - 9 way
- B - 'D' type connector - 15 way (for output type SI only)
- F - Flying lead (no connector)

Cable length

- 10 - 1.0 meter (10 meters if 0M special requirement chosen)

Resolution

- For Vx and Cx:
10B - 1024 steps per revolution

For all other output types (counts or positions per revolution):

Decimal			Binary	
D32 - 320	D80 - 800	2D0 - 2000	09B - 512	12B - 4096
D40 - 400	1D0 - 1000		10B - 1024	13B - 8192
D50 - 500	1D6 - 1600		11B - 2048	

NOTE: Not all combinations are valid.

Series	Output type	Shaft size	Resolution	Cable length	Connector option	Body style and cable exit	Environment	Special requirements
RE36	IA	06	09B / D50 / D40 / D32 / 10B / 1D0 / D80 / 11B / 2D0 / 1D6 / 13B / 12B	10	A / F	2	A	00 / 06 / 0M
	IB							
	IC							
	SC							
	SI							
	Vx							
	Cx							
		10B	A / F					

Head office

RLS merilna tehnika d.o.o.
 Poslovna cona Žeje pri Komendi
 Pod vrbami 2
 SI-1218 Komenda
 Slovenia

T +386 1 5272100
F +386 1 5272129
E mail@rls.si
www.rls.si

Document issues

Issue	Date	Page	Corrections made
3	16. 5. 2017	1	RoHS certificate added, description amended
		3	Operating and technical specification amended
		4, 6	IA and IC outputs resolution option table and power consumption amended
		5	SC output power consumption amended and incremental diagram added
		6	IB output resolution option table amended
		8	Ordering code amended
4	4. 7. 2018	4 - 6	Resolutions amended, temperature amended on all outputs
5	2. 10. 2019	1, 4, 7	Speed amended
6	27. 1. 2020	6	Signal termination table added
7	19. 5. 2022	General	IP64/IP68 deleted, cable data amended

This product is not designed or intended for use outside the environmental limitations and operating parameters expressly stated on the product's datasheet. Products are not designed or intended for use in medical, military, aerospace, automotive or oil & gas applications or any safety-critical applications where a failure of the product could cause severe environmental or property damage, personal injury or death. Any use in such applications must be specifically agreed to by seller in writing, and is subject to such additional terms as the seller may impose in its sole discretion. Use of products in such applications is at buyer's own risk, and buyer will indemnify and hold harmless seller and its affiliates against any liability, loss, damage or expense arising from such use. Information contained in this datasheet was derived from product testing under controlled laboratory conditions and data reported thereon is subject to the stated tolerances and variations, or if none are stated, then to tolerances and variations consistent with usual trade practices and testing methods. The product's performance outside of laboratory conditions, including when one or more operating parameters is at its maximum range, may not conform to the product's datasheet. Further, information in the product's datasheet does not reflect the performance of the product in any application, end-use or operating environment buyer or its customer may put the product to. Seller and its affiliates make no recommendation, warranty or representation as to the suitability of the product for buyer's application, use, end-product, process or combination with any other product or as to any results buyer or its customer might obtain in their use of the product. Buyer should use its own knowledge, judgment, expertise and testing in selecting the product for buyer's application, end-use and/or operating environment, and should not rely on any oral or written statement, representation, or samples made by seller or its affiliates for any purpose. EXCEPT FOR THE WARRANTIES EXPRESSLY SET FORTH IN THE SELLER'S TERMS AND CONDITIONS OF SALE, SELLER MAKES NO WARRANTY EXPRESS OR IMPLIED WITH RESPECT TO THE PRODUCT, INCLUDING ANY WARRANTY OF MERCHANTABILITY OR FITNESS FOR ANY PARTICULAR PURPOSE, WHICH ARE DISCLAIMED AND EXCLUDED. All sales are subject to seller's exclusive terms and conditions of sale which, where the seller is (a) RLS merilna tehnika d.o.o., are available at <https://www.rls.si/customer-service>, (b) Renishaw, Inc., are available at <http://www.renishaw.com/Shop/legal/en/-42186>, or (c) another person, are available on request, and in each case, are incorporated herein by reference, and are the exclusive terms of sale. No other terms and conditions apply. Buyer is not authorized to make any statements or representations that expand upon or extend the environmental limitations and operating parameters of the products, or which imply permitted usage outside of that expressly stated on the datasheet or agreed to in writing by seller.

RLS merilna tehnika d.o.o. has made considerable effort to ensure the content of this document is correct at the date of publication but makes no warranties or representations regarding the content. RLS merilna tehnika d.o.o. excludes liability, howsoever arising, for any inaccuracies in this document. © 2022 RLS d.o.o.