

# Artos™

## Rotary and Linear Absolute Magnetic Encoder System

**Artos™ is an absolute magnetic encoder system designed for motion control applications as a feedback element for angle and velocity control loops.** A highly reliable measurement principle and processing provide low position latency, high resolution and high angular velocity. The robust design protects the readhead and magnetic ring/scale from liquid ingress and high temperatures, so they remain undamaged even in extremely contaminated and hot environments.

TRUE  
ABSOLUTE  
SYSTEM

COMPACT  
ROBUST  
DESIGN

HIGH  
SPEED AND  
RESOLUTION



### Features and benefits

- ▶ True absolute system
- ▶ High accuracy and resolution
- ▶ Suitable for highly dynamic control loops
- ▶ Robust design and great EMC compatibility
- ▶ SSI and BiSS communication protocols
- ▶ Speeds up to 30,000 rpm for rotary and 20 m/s for linear applications
- ▶ Compatible with rings and linear/partial arc scales
- ▶ Wide installation tolerances
- ▶ IP67 protection class



MACHINE TOOL



ASSEMBLY LINES



GIMBALS



INDUSTRIAL AUTOMATION



HARSH ENVIRONMENT

# General information

Artos™ provides a true-absolute position information immediately after power-on via the selected communication protocol. The encoder system is extremely reliable due to the large installation tolerances (axial/radial/tangential offsets) and the robust IP67 design of the ring and readhead.







The measuring principle is based on a magnetic ring/scale magnetised with the incremental and absolute track with a pseudo-random binary sequence (PRBS) read by RLS proprietary sensor technology. Once installed, the encoder system does not need to be calibrated. To ensure the installation is correct, the operator can observe the setup LED while rotating the magnetic ring/scale in either direction.

The magnetic ring is available in two versions: exposed and protected with a cover foil. The version with the visible elasto-ferrite layer, called the exposed ring, is intended for applications where aggressive liquids are not expected to damage the sensitive part of the ring. The exposed ring can withstand dust, moisture and dirt. If, on the other hand, a thin layer of stainless steel is applied over the elasto-ferrite layer, the ring becomes more robust and suitable for harsh environments. The cover foil can be applied in two different ways. In one variant, the cover foil is wrapped around the circumference of the ring, with the elasto-ferrite layer of the ring visible from the sides. This type of protection is suitable for high rotational speeds and protects the sensitive elasto-ferrite layer from rotational forces. In the second variant, the cover foil is applied and welded around the entire circumference. This type of protection gives the ring IP67 protection and can withstand significantly higher rotational speeds. The fully protected version is intended for demanding applications, e.g. in the machine tool industry, where various aggressive liquids are present - oils, coolants, greases, solid non-ferrous particles (swarf) and high-speed applications.

The magnetic rings are available in different sizes, from 57 mm to 478 mm outer diameter. In addition, the readhead is compatible with a linear flexible absolute scale of up to 32 m in length, which can also be used for partial arc applications from the smallest diameter of 200 mm upwards. For linear and partial arc applications, the flexible magnetic scale DS19 is used. The use of the DS19 magnetic scale does not support a full 360° rotation of the shaft, but is intended for applications with large shafts where a full rotation is not required.



## Choose your Artos system

The enclosed readhead is compatible with solid rings, solid scales and the flexible linear/partial arc scales DS19. The SAS19 scale, offered in exposed and welded (IP67-rated) versions, provides higher accuracy of ±6 µm/m.

 <p>Artos™ readhead</p>	+	<p><b>Exposed SAR radial ring</b></p> 	<p><b>SAR ring with cover foil</b></p> 	<p><b>SAR ring with welded cover foil</b></p> 
		<p><b>Partial arc scale DS19</b></p> 	<p><b>Linear scale DS19</b></p> 	<p><b>SAS19 exposed scale</b></p> 

Further information on compatible rings and scales can be found in [SARD01](#) and [ASD01](#), available at [RLS Media center](#).

# Storage and handling

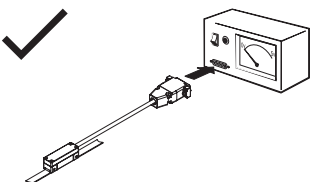
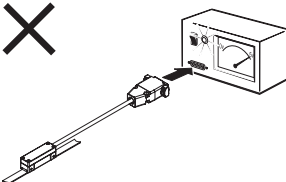
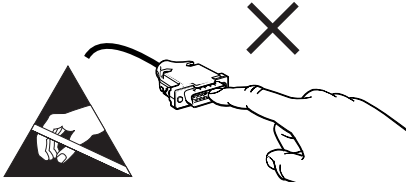
Storage temperature	Operating temperature	IP protection
 -40 °C to +85 °C	 -40 °C to +85 °C	 IP67
		

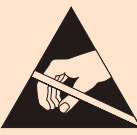

**Readhead is ESD sensitive - handle with care.**  
 Do not touch electronic circuit, wires or sensor area without proper ESD protection or outside of ESD controlled environment.

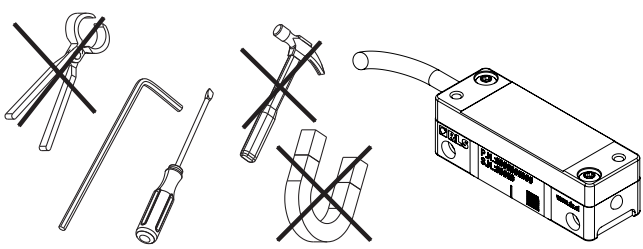

This encoder system is a high performance measuring instrument and should be handled with the same care as any other precision instrument. The use of industrial tools during installation or contact with strong magnets, such as a magnetic base, is not recommended as there is a risk that parts of the system will be damaged and may not function to specifications as a result.

## Packaging

Each readhead is individually packaged in an antistatic bag, in accordance with ESD protection measures.

## Labeling/Engraving

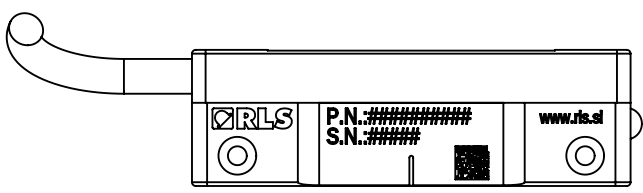

The engraving on the readhead contains a 20-digit part number, a 6-digit serial number and a QR code with a serial number.

## Dimensions and installation drawings

Dimensions and tolerances are in mm. Dimensions without tolerance values are in accordance with ISO 2768-m.



### Readhead

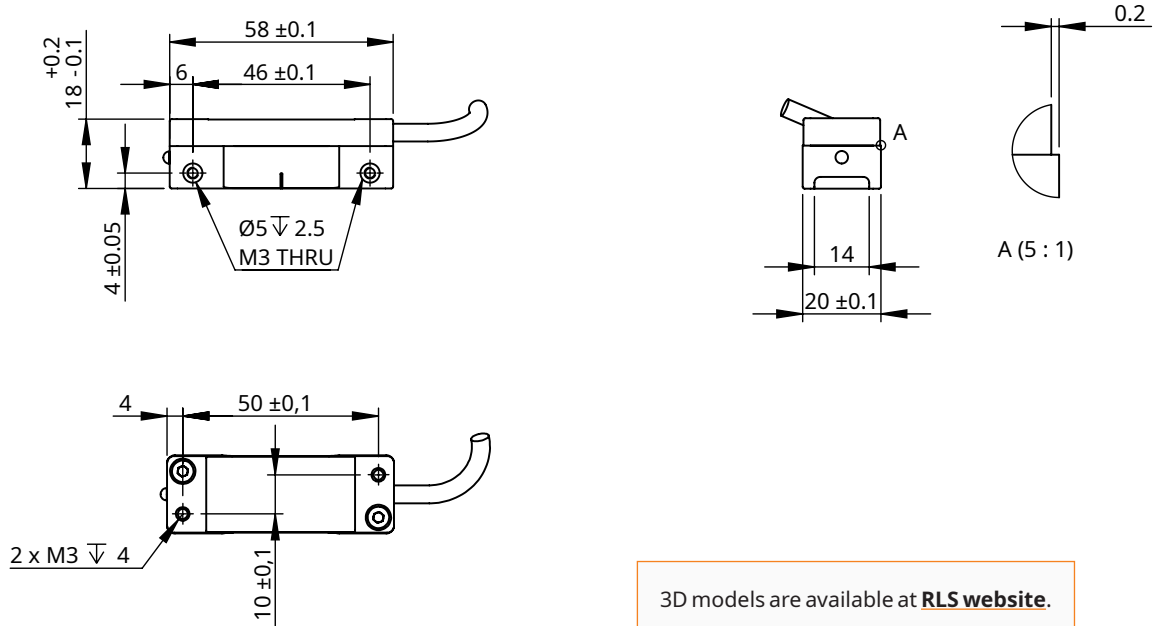

#### General tolerances for linear dimensions according to ISO 2768-m

Tolerance class	up to 6	6-30	30-120
<b>m (medium)</b>	±0.1	±0.2	±0.3

Further information on compatible rings and scales can be found in [SARD01](#) and [ASD01](#), available at [RLS Media center](#).

# Installation instructions

## Installation instructions with rings or linear scales

The readhead can be installed in 3 different ways - from left, right or top, as shown in the drawings below. Carefully plan the orientation of the readhead and the ring/scale. The engraving on the ring and the print on the scale can be used to determine the orientation.

We recommend the use of M3 fasteners with washers. For more information, please refer to the [Table of recommended fastener tightening torques](#).

After mounting the ring/scale with the readhead, make sure that the distance between them corresponds exactly to the installation dimensions and tolerances specified in the data sheets [SARD01](#) and [ASD01](#). The use of a special installation tool is recommended for correct alignment of the readhead. If no special installation tool is available, a simple plastic shim can also be used to align the air gap, although the plastic shim does not align the readhead in all important directions (tangential, axial, yaw, pitch and roll offsets). It is recommended to set the air gap to the optimal value.

Please check the optimum ride height for each ring size in [SARD01](#) or for the scale in [ASD01](#) data sheet. Make sure that the readhead, shim and ring or magnetic scale are fully aligned. As soon as the screws holding the readhead are tightened, the spacer can be removed.

The LED on the readhead must light up green at all measuring positions, otherwise the installation has not been performed correctly. More information on the LED can be found in the chapter [Status indicator LED](#).

**Improper mounting of the ring/scale and the readhead can impair the performance or function of the magnetic encoder system and lead to total failure.**

**Variant A (left side)**

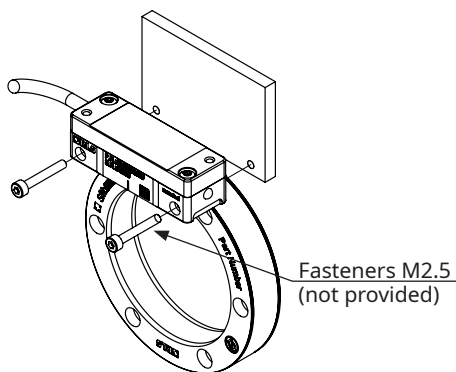

**Variant B (right side)**

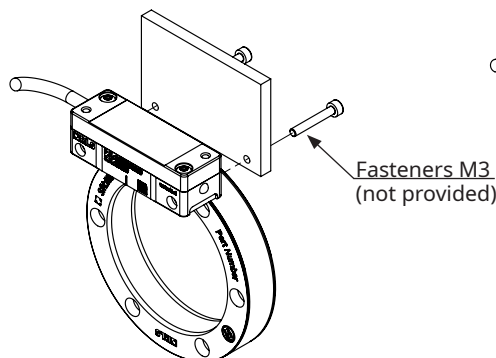

**Variant C (top side)**

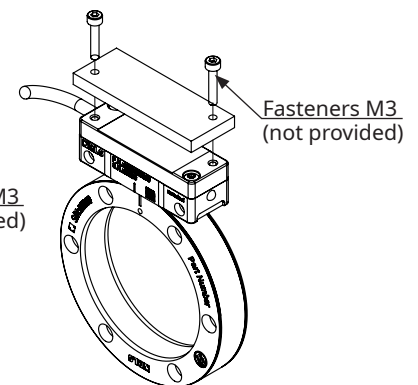

The magnetic encoder system must be used in accordance with the specified degree of protection. The following factors must be taken into account: IP protection class, operating temperature, external magnetic field, mechanical load and EMC compatibility.

## Effects of external magnetic fields

The magnetic encoder system is sensitive to external magnetic fields. The extent to which the magnetic encoder system is affected depends on the magnitude and direction of the external magnetic field. In particular, the rapidly changing stray magnetic fields affect the system and can change its function. Field strengths greater of more 1 mT can cause the system to malfunction, resulting in the readhead reporting an invalid position despite inactive error and warning bits in the detailed status and a green LED. Magnetic field strengths of more than 25 mT cause irreversible damage to the magnetic ring or scale and must be replaced.

Further information and useful tips on the installation can be found in data sheets [SARD01](#) and [ASD01](#).

# Technical specifications

## System specifications

<b>Type of absolute measurement</b>	Pseudorandom binary sequence (PRBS) absolute code; RLS proprietary sensor technology
<b>Reading type</b>	Radial
<b>Hysteresis</b>	<3.5 µm at nominal ride height SAR057 = 25 arcsec SAR081 = 18 arcsec SAR114 = 13 arcsec SAR162 = 9 arcsec SAR229 = 6 arcsec SAR325 = 4 arcsec SAR478 = 3 arcsec
<b>Unidirectional repeatability</b>	<1.5 µm
<b>Resolution</b>	Rings: up to 23 bits binary resolution (depends on the ring size) Magnetic scales: up to ~0.100 µm See <b>Table of available resolutions.</b>
<b>Sensor and processing latency</b>	11 µs
<b>Internal loop refresh rate</b>	91 kHz
<b>Maximum speed during power up</b>	Rotary: 500 rpm Linear: 10 m/s

## Electrical data

<b>Power supply</b>	From 4.75 V to 30 V (voltage on readhead, consider voltage drop over cable)
<b>Reverse polarity protection</b>	Yes
<b>Set-up time after switch-on</b>	<200 ms
<b>Power consumption (without load)</b>	0.7 W
<b>Communication standard</b>	Differential line driver signal (RS422)
<b>Output load</b>	±40 mA
<b>ESD protection</b>	HBM, max. ±2 kV

## Mechanical data

<b>Material</b>	Aluminium (anodised)
<b>Mass</b>	70 g (with 1 m cable, no connector)

## Environmental data

<b>Operating and storage temperature</b>	-40 °C to +85 °C
<b>Vibrations (55 Hz to 2000 Hz)</b>	30 g m/s <sup>2</sup> (IEC 60068-2-6)
<b>Shocks (11 ms)</b>	100 g (IEC 60068-2-27)
<b>Humidity</b>	100 % (condensation permitted)
<b>EMC Immunity</b>	IEC 61000-6-2
<b>EMC Emission</b>	IEC 61000-6-4
<b>Environmental sealing</b>	IP67 (according to IEC 60529)
<b>Maximum external magnetic field during operation</b>	1 mT

## Cable

<b>Cable type</b>	8 core, PUR high flexible cable, braided shield, pairs not twisted
<b>Outer diameter</b>	Max 4.5 mm
<b>Wires AWG</b>	White and brown wires 0.14 mm <sup>2</sup> , 26 AWG, 0.14 Ω/m Other wires 0.08 mm <sup>2</sup> , 28 AWG, 0.23 Ω/m
<b>Cable bending radius</b>	Dynamic 50 mm Static 10 mm
<b>Mass</b>	34 g/m
<b>Durability</b>	10 million cycles at 50 mm bend radius
<b>Torsion</b>	Continuous torsion not allowed
<b>Maximum cable length</b>	15 m (including extensions)

## Cable bending radius

Fixed laying application

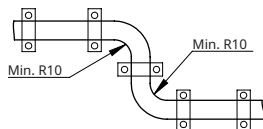

Continuously flexible application

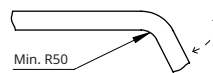

The cable requires adequate strain relief to ensure its integrity and avoid lateral forces that could damage the cable entry. The bending radius of the cable also applies to the connector side.

## Cable installation

Dimensions and tolerances are in mm. Dimensions without tolerance values are in accordance with ISO 2768-m.

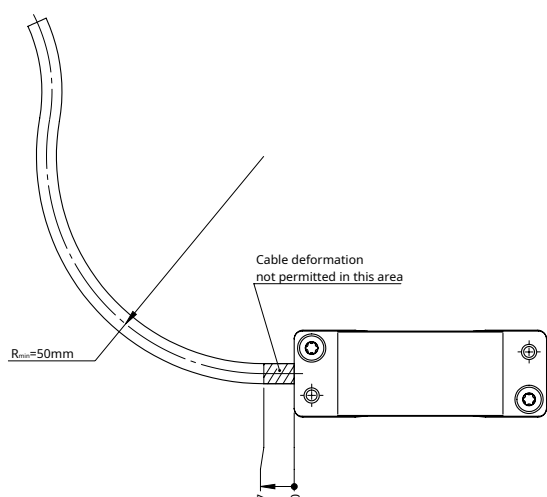



# Electrical connections

## Shield connection

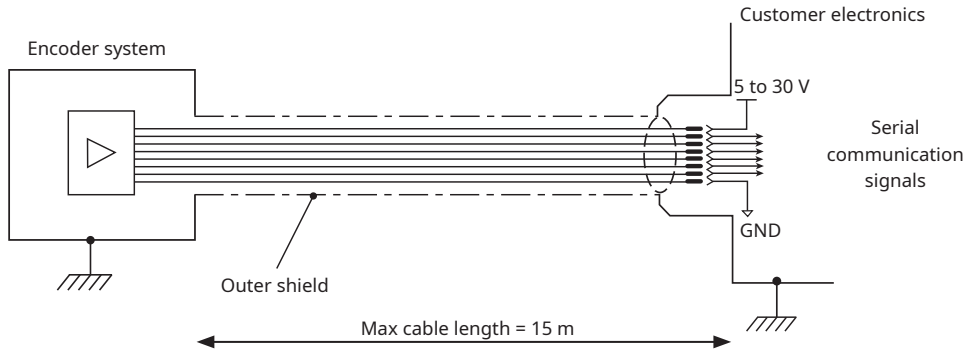
The following figure shows the recommended shield termination in order to ensure electromagnetic compatibility.



The encoder housing is galvanically connected to the connector housing. To achieve EMC compliance, the encoder system must be correctly integrated. In particular, attention to shielding arrangements is essential.

Function	Signal	Wire colour (flying leads)	9 pin D type plug	M12 8-way
				
Power	5 V	Brown	5	2
	0 V	White	9	8
Serial communication	CLK+ / MA+	Green	2	3
	CLK- / MA-	Yellow	3	4
	DATA+ / SLO+	Blue	6	7
	DATA- / SLO-	Red	7	6
Reserved	-	Pink	-	-
	-	Grey	-	-
Shield	Shield	Bare wire	Case	Case

### 9-way D-type connector (male type)

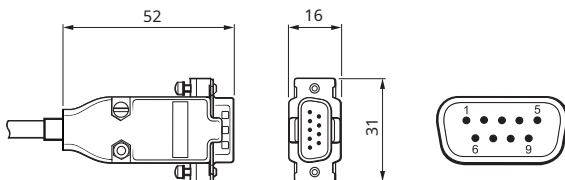

### M12 8-way sealed (overmould) connector (male type)\*

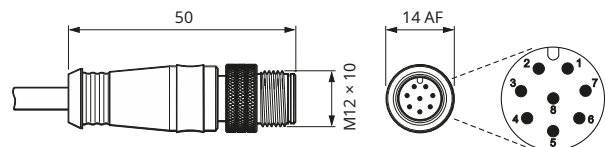

\* Subject to availability. Available with overmoulded or metal housing connector version.

## Extension cable

The extension cable is optional and can be supplied by RLS. Refer to the [Extension cable](#) for options.









## Status indicator LED

Once the ring or magnetic scale has been installed, the readhead can be easily mounted on the machine using the LED setup indicator. The LED indicator shows the internal status of the encoder and is used to facilitate the installation and diagnosis of the encoder system. According to the table [Detailed status description](#), certain errors are latched, resulting in LED indicating error status persistently. To clear latched error statuses, communication with readhead or readhead power cycle is required.



Slow flashing of LED indicates that the encoder is receiving power, but communication between the encoder and the controller has not yet been established. The error status has a higher priority than the warning status in the LED signaling. The signaling of LED may differ from the encoder status signaled by the controller. In case of error/warning the LED remains red/orange for at least 200 ms.

LED Status	Status	Description
 <b>Green</b>	Normal operation	Position data is valid.
 <b>Orange</b>	Warning	<ul style="list-style-type: none"> <li>The internal temperature is near operational limits.</li> <li>The encoder system is near operational limits. For details please check possible causes under the Error status.</li> </ul>
 <b>Red</b>	Error	Position data is not valid. Possible causes: <ul style="list-style-type: none"> <li>The distance between the readhead and the magnetic scale is too large.</li> <li>The readhead is out of alignment with the ring or magnetic scale or they are demagnetised.</li> <li>Incorrect orientation of the readhead and ring or magnetic scale.</li> <li>The encoder speed is out of operational limits.</li> </ul>
 <b>Fast red flashing</b>	Error	Position data is not valid. Internal system error.
 <b>Slow red, green or orange flashing</b>	/	The communication has not been established.
 <b>Irregular flashing</b>	/	Power supply too low.
 <b>No light</b>	/	No power supply.

The LED signal statuses listed in the table above do not indicate non-optimal installation of the readhead, e. g. an accuracy outside the specified range. To ensure optimal installation, it is recommended to use the designated installation tool.

During installation, it is advisable to rotate the ring or magnetic scale in both directions over the entire range of motion to observe the encoder status on the LED (the maximum rotational speed is 5 rpm or 50 mm/s). As soon as the LED indicator remains green over the entire range of motion, this indicates that the encoder is correctly installed.

## Troubleshooting

If the readhead reports an error during operation due to incorrect decoding of the absolute position on the magnetic ring/scale, this indicates a serious problem. Serious problems include incorrect installation or a damaged magnetic pattern on the ring or scale. To determine the cause of the problem, please proceed as follows:

- Make sure that the part number on the readhead and the ring or scale match the required combination. The valid combination of ring and readhead can be verified with the first 6 letters of the part number.
- Verify that the installation matches the specification of the encoder for the orientation of the readhead relative to the ring/scale (ride height/radial offset, lateral/axial offset, centerline/ tangential, roll, pitch and yaw offsets).
- If possible, check the error location on the magnetic ring/scale with the magnetic viewer for an abnormal pattern in the magnetic code.
- Check the power supply. This is especially important for longer cable lengths. Take into account the voltage drop over the cable. Check the **Minimum input voltage vs. cable length.**

# BiSS C Communication interface

The absolute position data and the status are available via the BiSS C protocol. The length of the position data varies depending on the combination of SAR ring, linear/partial arc scale and selected resolution. In combination with the SAR ring, the length of the position data is up to 23 bits. In combination with the scale, the length of the position data is up to 29 bits. The position data is always right-aligned, MSB first and without padding bits. The absolute position is followed by 2 general status bits, which are active low (error and warning) and 6 bits CRC (inverted).

BiSS is implemented for point-to-point operation, multiple slaves are not supported. The communication is unidirectional.

## Electrical connection

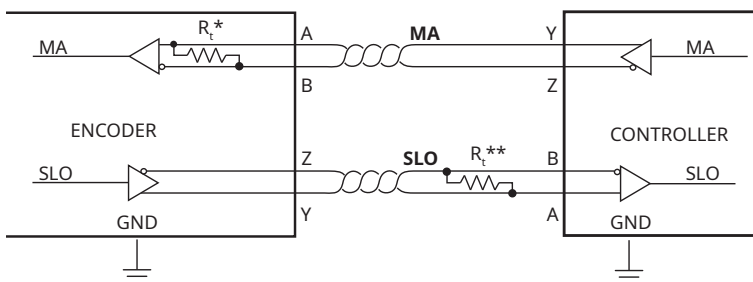

### Signals

<b>MA</b>	Master clock.
<b>SLO</b>	Slave out. Data is output on rising edge on MA.

\* The MA and SLO lines are 5 V RS422 compatible differential pairs. The termination resistor on the MA line is integrated inside the encoder.

\*\* Termination at the controller is required, if the total cable length is longer than 5 m. The nominal impedance of the cable is 120 Ω.

## BiSS C timing diagram

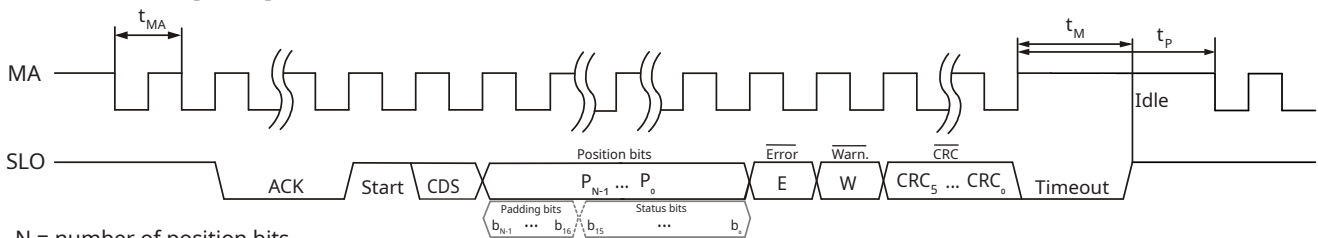

N = number of position bits

In case of an error, the position data field is replaced by the detailed status described on [page 13](#). The detailed status is 16 bits long and right-aligned. Other unused bits in the position field become padding bits and are set to zero. The exact length of the position data is determined by the combination of ring/scale and resolution. See the [Table of available resolutions](#).

## BiSS C Parameters

<b>Interface type</b>	BiSS C unidirectional (point-to-point)
<b>Signal level</b>	RS422
<b>Position data encoding</b>	Pure binary
<b>Max MA frequency</b>	5 MHz
<b>Min MA frequency</b>	500 kHz
<b>Length of position data</b>	Depends on the resolution. See <a href="#">Table of available resolutions</a> .
<b>Length and type of status data</b>	2 bits (Error, Warning). Active low. Error/warning descriptions, can be found in the <a href="#">LED table</a> .
<b>CRC length and type</b>	6 bits (inverted bit output - polynomial 0x43)
<b>ACK length</b>	5 bits
<b>CDS bit</b>	Always zero
<b>Communication delay</b>	1.6 μs at 5 MHz MA freq.; otherwise 8 MA clock periods
<b>Timeout</b>	≥15 μs or when the SLO line goes high
<b>Data frame rate</b>	Up to 44 kHz

# SSI Communication interface

The absolute position data and the status are available via the SSI protocol. The length of the position data varies depending on the combination of SAR ring, linear/partial arc scale and selected resolution. In combination with the SAR ring, the length of the position data is up to 23 bits. In combination with the scale, the length of the position data is up to 29 bits. The position data is always right-aligned, MSB first and without padding bits. The absolute position is followed by 2 general status bits, which are active low (error and warning), and 16 bits with detailed status.

## Electrical connection

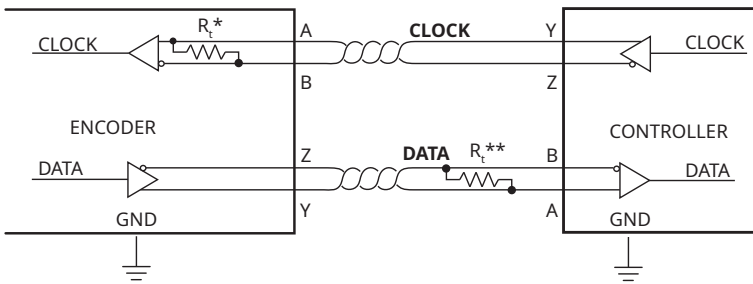

\* The CLOCK and DATA lines are 5 V RS422 compatible differential pairs. The termination resistor on the CLOCK line is integrated in the encoder.

\*\* Termination at the controller is required if the total cable length is more than 5 m. The nominal impedance of the cable is 120 Ω.

## SSI timing diagram

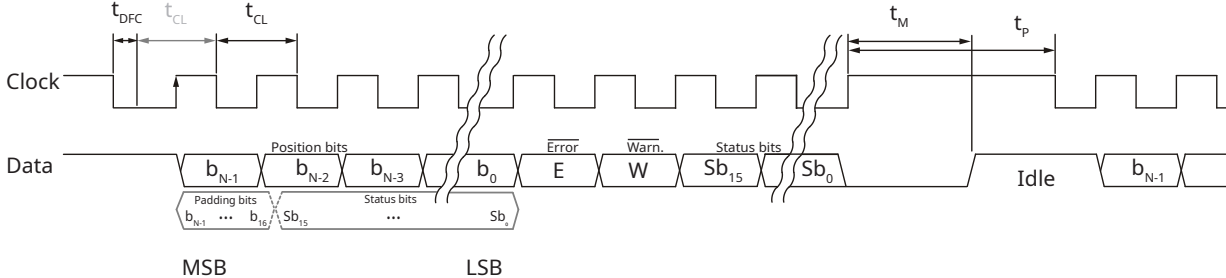

N = number of position bits

The detailed status bits follow the warning bit in the data frame. In case of error, the position data field is also replaced by the detailed status described on **page 13**. The detailed status is 16 bits long and right-aligned. Other unused bits in the position field become padding bits and are set to zero. The exact position data length is determined by the ring/scale and resolution combination. Check the table of available resolutions.

The controller requests the position and status data of the encoder by sending a pulse train to the Clock input. The Clock signal always starts from high. The first falling edge of the Clock latches the last position data available and on the first rising edge of the Clock the most significant bit (MSB) of the position is transmitted to the Data output. If the time  $t_{DFC}$  is extended for additional 2 μs, the maximum clock frequency limit is 2.5 MHz instead of 500 kHz. The Data output should then be read on the following falling edge. On subsequent rising edges of the Clock signal the next bits are transmitted.

After the transmission of the last bit the Data output goes to low. When the  $t_M$  time expires, the Data output goes high. The Clock signal must remain high for at least  $t_P$  before the next reading can take place.

While reading the data, the half of a Clock period  $t_{CL}$  must always be less than  $t_M$ . However, reading the encoder position can be terminated at any time by setting the Clock signal to high for the duration of  $t_M$ .

## SSI Parameters

<b>Interface type</b>	SSI unidirectional (point-to-point)
<b>Signal level</b>	RS422
<b>Position data encoding</b>	Pure binary
<b>Max CLOCK frequency</b>	500 kHz (2.5 MHz with first clock delay function on the controller)
<b>Min CLOCK frequency</b>	80 kHz
<b>Length of position data</b>	Depends on the resolution. See <b>Table of available resolutions</b> .
<b>Length and type of status data</b>	2 bits (Error, Warning). Active low. Error/warning descriptions, can be found in the <b>LED table</b> .
<b>Timeout <math>t_M</math></b>	$\geq 20 \mu s$ or when the DATA line goes high
<b>Max request rate at highest resolution</b>	Up to 25 kHz
<b>Delay first clock <math>t_{DFC}</math></b>	2 - 10 $\mu s$
<b>Pause time <math>t_p</math></b>	20 $\mu s$

## Detailed status description

BiSS and SSI - detailed status replaces position data while error bit is active.

Bit number	Description of error/warning	Error / Warning	Clearing
b15	Reserved	/	/
b14	Temperature warning. Temperature has exceeded the upper specified limit (85 °C).	Warning	When absent
b13	Signal warning. The signals from the sensor are distorted. The encoder performance (noise, accuracy, ...) may not be as specified. Check if the readhead is installed within specification. The encoder system may be damaged.	Warning	When absent
b12	Reserved	/	/
b11	Decoding warning. The amplitude on the absolute sensor is too close to the limit for reliable decoding. Check the installation of the readhead and try to improve it.	Warning	When absent
b10	Reserved	/	/
b9	Reserved	/	/
b8	Sensors mismatch error. The positions of the absolute and incremental sensors do not match. This is likely due to a damaged ring/scale or external magnetic fields. It could be a result of using incompatible rings/scales.	Error	On communication

DATA SHEET

DRD01\_06

Detailed status continued

Bit Num	Description of error/warning	Error /Warning	Clearing
b7	Decoding error. The amplitude on the absolute sensor is too low for reliable decoding. Check the installation of the readhead.	Error	When absent
b6	Signal error. The signals from the sensor are distorted beyond the ability to be reliably interpreted. Check if the readhead is installed within specification. Check the orientation of the ring/scale relative to the readhead (the engraving sides must match). The encoder system may be damaged.	Error	On communication
b5	Reserved	/	/
b4	System error. Malfunction inside the circuitry. To reset the System error bit, try to cycle the power supply while the rise time is shorter than 20 ms. If the error persists, <b>contact RLS</b> .	Error	On reset
b3	Reserved	/	/
b2	Reserved	/	/
b1	Position uninitialized error. The conditions for calculating the valid absolute position have not yet been met. The error should clear on communication. If it persists, this could be due to the following: <ul style="list-style-type: none"> <li>• The readhead mounting is incorrect.</li> <li>• The ring/scale is damaged.</li> <li>• The ring rotates at more than 500 rpm during the power up sequence or after the readhead is trying to recover from the error.</li> <li>• The linear speed is above 10 m/s during the power up sequence or after the readhead is trying to recover from the error.</li> </ul> <p>This error always sets in conjunction with other errors (except for decoding error). The error may also be set for a short period of time on first startup. However, it should clear automatically. If it does not, see reasons above.</p>	Error	On communication (except first time after startup)
b0	Reserved	/	/

## Cable length compensation

The readhead needs 70 ns to respond to incoming clocks ( $t_{RESP}$ ). The change on the Data signal is delayed by 70 ns after the rising edge on the Clock line. An additional delay is caused by the time the signal takes to propagate through the cable to the readhead and back ( $t_{PROP}$ ). This delay is typically 14 ns per 1 meter cable. The total cable length from the encoder to the receiver must be considered.

The total delay ( $t_{DELAY}$ ) is calculated as in the formula below.

A proper implementation of BiSS Master should automatically measure  $t_{DELAY}$  and adjust the internal timing to compensate for it.

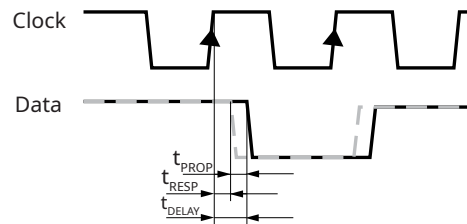

$$t_{DELAY} = t_{RESP} + t_{PROP} \times \text{cable length}$$

## Minimum input voltage vs. cable length

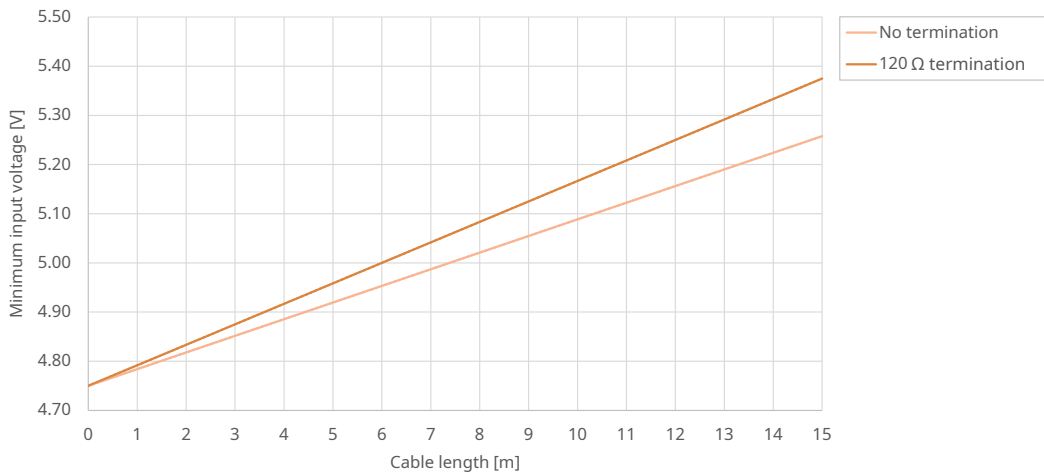

## Current consumption vs. power supply

Measurement was made on the readhead with a 1 m long cable without termination.

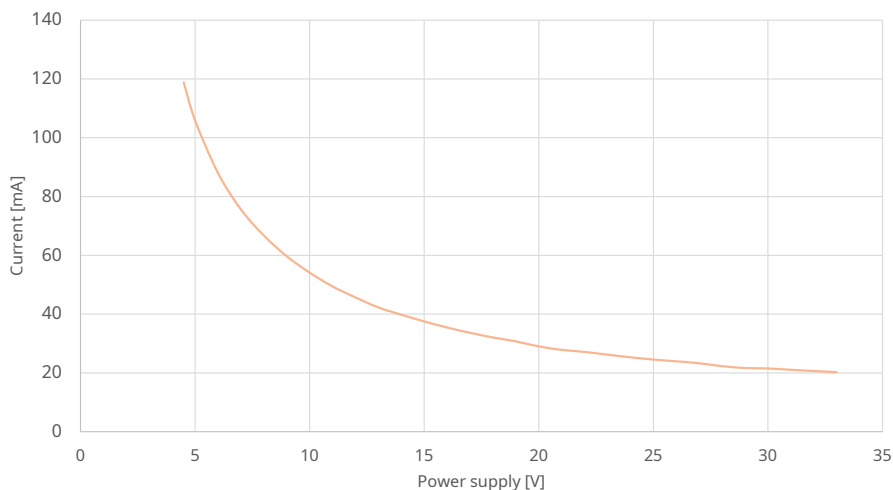

### Maximum frequency vs. cable length

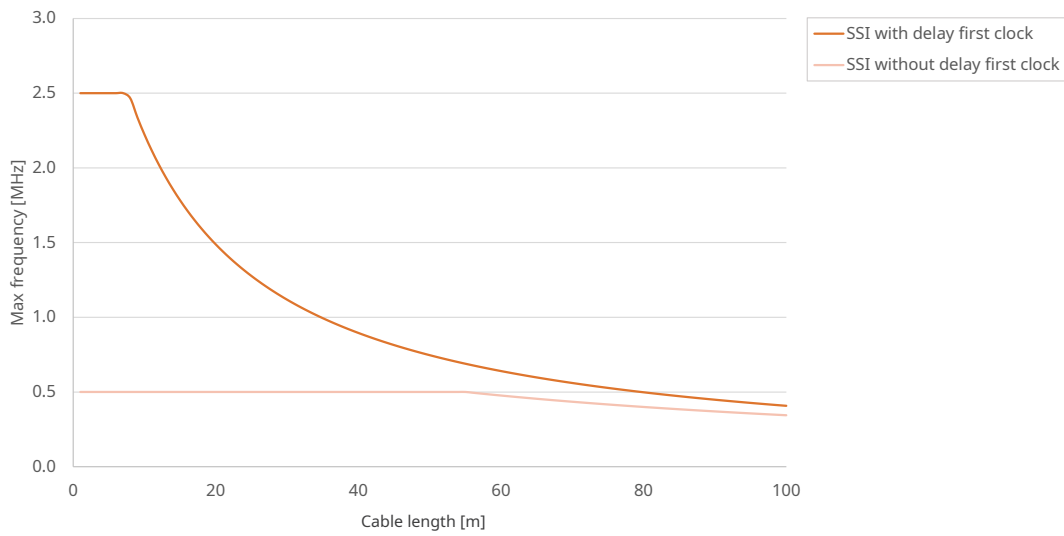

Cable length [m]	SSI [MHz]	SSI + delay first clock [MHz]
1	0.50	2.50
2	0.50	2.50
3	0.50	2.50
4	0.50	2.50
5	0.50	2.50
6	0.50	2.50
7	0.50	2.50
8	0.50	2.47
9	0.50	2.34
10	0.50	2.22
11	0.50	2.12
12	0.50	2.02
13	0.50	1.94
14	0.50	1.86
15	0.50	1.78

Cable length L [m]	Tolerance [mm]
≤ 2	+30 / -0
2 < L ≤ 7	+40 / -0
7 < L ≤ 15	+50 / -0



# Part numbering

**DHR 057 DC 23B A A S 10D A 00**

## Encoder family

- DHR** - Absolute readhead, enclosed, for SAR rings
- DHL** - Absolute readhead, enclosed, for linear and partial arc scales

## Compatibility

### Ring OD:

- 057** - 57 mm      **229** - 229 mm
- 081** - 81 mm      **325** - 325 mm
- 114** - 114.2 mm   **478** - 478 mm
- 162** - 162 mm

### Linear and partial arc scale

- 001** - DS19 ( $\leq 2$  m, minimum bending diameter 200 mm,  $\pm 10$   $\mu$ m accuracy)
- 002** - DS19 ( $2 \leq 8$  m, minimum bending diameter 630 mm,  $\pm 10$   $\mu$ m accuracy)

### Linear scale

- 003** - DS19 ( $8 \leq 32$  m, no bending allowed,  $\pm 15$   $\mu$ m accuracy)
- 004** - SAS19 (up to 1.36 m,  $\pm 6$   $\mu$ m accuracy)

## Output type

- DC** - BiSS C output
- SC** - SSI output

## Resolution

### For rings (in CPR):

- |                        |                        |                        |                        |
|------------------------|------------------------|------------------------|------------------------|
| <b>23B</b> - 8,388,608 | <b>18B</b> - 262,144   | <b>0DB</b> - 1,024,000 | <b>01B</b> - 512,000   |
| <b>22B</b> - 4,194,304 | <b>17B</b> - 131,072   | <b>0EB</b> - 737,280   | <b>0JB</b> - 360,000   |
| <b>21B</b> - 2,097,152 | <b>0AB</b> - 5,898,240 | <b>0FB</b> - 368,640   | <b>0KB</b> - 256,000   |
| <b>20B</b> - 1,048,576 | <b>0BB</b> - 2,949,120 | <b>0GB</b> - 184,320   | <b>0LB</b> - 180,000   |
| <b>19B</b> - 524,288   | <b>0CB</b> - 1,474,560 | <b>0HB</b> - 720,000   | <b>0MB</b> - 1,504,000 |

### For linear and partial arc scales:

- |                                  |                               |                            |                           |                          |
|----------------------------------|-------------------------------|----------------------------|---------------------------|--------------------------|
| <b>14U</b> - 0.122070313 $\mu$ m | <b>10U</b> - 1.953125 $\mu$ m | <b>06U</b> - 31.25 $\mu$ m | <b>8D0</b> - 0.25 $\mu$ m | <b>010</b> - 10 $\mu$ m  |
| <b>13U</b> - 0.244140625 $\mu$ m | <b>09U</b> - 3.90625 $\mu$ m  | <b>05U</b> - 62.5 $\mu$ m  | <b>001</b> - 1.0 $\mu$ m  | <b>10D</b> - 0.1 $\mu$ m |
| <b>12U</b> - 0.48828125 $\mu$ m  | <b>08U</b> - 7.8125 $\mu$ m   | <b>04U</b> - 125 $\mu$ m   | <b>002</b> - 2 $\mu$ m    | <b>20D</b> - 0.2 $\mu$ m |
| <b>11U</b> - 0.9765625 $\mu$ m   | <b>07U</b> - 15.625 $\mu$ m   | <b>4D0</b> - 0.5 $\mu$ m   | <b>005</b> - 5 $\mu$ m    |                          |

Not all part number combinations are valid. Refer to the table of available combinations on the following pages.

## Cable length

- |                  |                  |                   |
|------------------|------------------|-------------------|
| <b>10D</b> - 1 m | <b>40D</b> - 4 m | <b>10M</b> - 10 m |
| <b>20D</b> - 2 m | <b>50D</b> - 5 m | <b>12M</b> - 12 m |
| <b>30D</b> - 3 m | <b>70D</b> - 7 m | <b>15M</b> - 15 m |

The maximum cable length is 15 m. If an extension cable is used, the readhead cable length + extension cable length must not exceed 15 m.

## Connector type

- A** - 9 pin D type plug
- F** - Flying lead (no connector)
- W** - M12 male overmould/metal housed connector \*

\* Subject to availability. The M12 overmould and M12 metal housing connectors are used interchangeably.

## Special requirements

- 00** - No special requirements

**Table of available resolutions (DHR readhead with SAR rings)**

Readhead	Outer diameter	Pole number	CPR (bits)	Position data length	Resolution part number
DHR	057	90	1,474,560	21	0CB
			737,280	20	0EB
			368,640	19	0FB
			184,320	18	0GB
			180,000	18	0LB
			1,048,576 (20)	20	20B
			524,288 (19)	19	19B
			262,144 (18)	18	18B
			131,072 (17)	17	17B
	081	128	2,097,152 (21)	21	21B
			1,048,576 (20)	20	20B
			524,288 (19)	19	19B
			262,144 (18)	18	18B
			256,000	18	0KB
	114	180	2,949,120	22	0BB
			1,474,560	21	0CB
			737,280	20	0EB
			368,640	19	0FB
			360,000	19	0JB
			2,097,152 (21)	21	21B
			1,048,576 (20)	20	20B
			524,288 (19)	19	19B
			262,144 (18)	18	18B
	162	256	4,194,304 (22)	22	22B
			2,097,152 (21)	21	21B
			1,048,576 (20)	20	20B
			524,288 (19)	19	19B
			512,000	19	0IB
	229	360	5,898,240	23	0AB
			2,949,120	22	0BB
			1,474,560	21	0CB
			737,280	20	0EB
			720,000	20	0HB
			4,194,304 (22)	22	22B
			2,097,152 (21)	21	21B
			1,048,576 (20)	20	20B
			524,288 (19)	19	19B
	325	512	8,388,608 (23)	23	23B
			4,194,304 (22)	22	22B
			2,097,152 (21)	21	21B
			1,048,576 (20)	20	20B
			1,024,000	20	0DB
	478	752	8,388,608 (23)	23	23B
			4,194,304 (22)	22	22B
			2,097,152 (21)	21	21B
			1,048,576 (20)	20	20B
			1,504,000	21	0MB

Further information can be found in **SARD01** data sheet.

**Table of available combinations (DHR readhead with SAR rings)**

Series	Outer diameter	Output type	Resolution	N/A	N/A	N/A	Cable length	Connector type	Special requirements
DHR	057	DC / SC	17B / 18B / 19B / 20B / 0LB / 0GB / 0FB / 0EB / 0CB	A	A	S	10D / 20D / 30D / 40D / 50D / 70D / 10M / 12M / 15M	A / F / W	00
	081		18B / 19B / 20B / 21B / 0KB						
	114		18B / 19B / 20B / 21B / 0JB / 0FB / 0EB / 0CB / 0BB						
	162		19B / 20B / 21B / 22B / 0IB						
	229		19B / 20B / 21B / 22B / 0HB / 0EB / 0CB / 0BB / 0AB						
	325		20B / 21B / 22B / 23B / 0DB						
	478		23B / 22B / 21B / 20B / 0MB						

**Table of available resolutions (DHL readhead with SAS19/DS19 scale)**

Readhead	Linear/partial arc scale	Interpolation factor	Resolution in $\mu\text{m}$	Position data length	Resolution part number
DHL	001 / 002 / 003 / 004	14	0.122070313	28	14U
		13	0.244140625	27	13U
		12	0.48828125	26	12U
		11	0.9765625	25	11U
		10	1.953125	24	10U
		09	3.90625	23	09U
		08	7.8125	22	08U
		07	15.625	21	07U
		06	31.25	20	06U
		05	62.5	19	05U
		04	125	18	04U
		8000	0.25	27	8D0
		4000	0.5	26	4D0
		2000	1	25	001
		1000	2	24	002
		400	5	23	005
		200	10	22	010
20000	0.1	29	10D		
10000	0.2	28	20D		

**Table of available combinations (DHL readhead with SAS19/DS19 scale)**

Series	Linear/partial arc scale	Output type	Resolution	N/A	N/A	N/A	Cable length	Connector type	Special requirements
DHL	001 / 002 / 003 / 004	DC / SC	14U / 13U / 12U / 11U / 10U / 09U / 08U / 07U / 06U / 05U / 04U / 4D0 / 8D0 / 001 / 002 / 005 / 010 / 10D / 20D	A	A	S	10D / 20D / 30D / 40D / 50D / 70D / 10M / 12M / 15M	A / F / W	00

### Extension cable

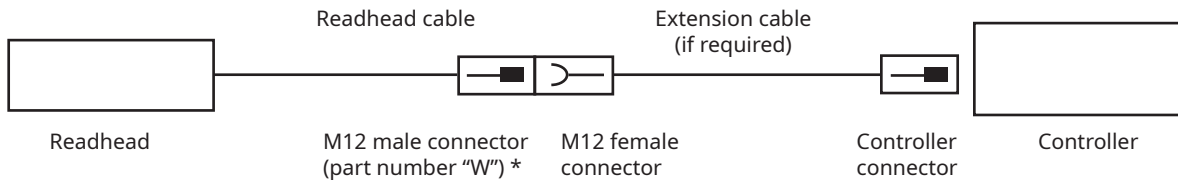

\* Input of the extension cable is M12 female overmould connector. When using an extension cable the LA12 readhead must be ordered with M12 (part number "W") connector.

	EC	12000	C	A	00
<b>Extension Cable</b>					
EC - Extension cable					
<b>Cable length *</b>					
02000 - 2 m					
03000 - 3 m					
04000 - 4 m					
06000 - 6 m					
08000 - 8 m					
12000 - 12 m					
* Lengths 4 m and 8 m in stock. For other lengths longer lead time may apply.					
<b>Readhead compatibility</b>					
C - DHR (Artos readhead)					
<b>Output connector type</b>					
A - 9-pin D-type plug					
F - Flying leads					
W - M12 male overmould/metal housed connector **					
** Subject to availability, may be supplied with overmould or metal housing connector version.					
<b>Special requirements</b>					
00 - No special requirements					

### Table of available combinations (Extension cables)

Series	Cable length	Readhead compatibility	Output connector type	Special requirements
EC	02000 / 03000 / 04000 / 06000 / 08000 / 12000	C	A / F / W	00

## Accessories

---



USB interface (for SSI and BISS C)  
**E201-9S**

Suitable for use with the readhead with up to 2 m long cable.



Extension cable  
**EC**



Installation tool for Artos<sup>™</sup> rings  
**II**

## Head office

---

### RLS Merilna tehnika d. o. o.

Poslovna cona Žeje pri Komendi  
Pod vrbami 2  
SI-1218 Komenda  
Slovenia

T +386 1 5272100  
E [mail@rls.si](mailto:mail@rls.si)

[www.rls.si](http://www.rls.si)

## Global support

---

Visit our [website](#) to contact your nearest sales representative.

### Document issues

Issue	Date	Page	Description
1	20. 3. 2024	-	New document
2	24. 4. 2024	19	Part numbering amended
3	21. 6. 2024	17	Part numbering amended
4	22. 8. 2024	16	Graph added
5	11. 11. 2024	3, 6	Temperature data amended
6	14. 3. 2025	2, 17, 19	New options added for SAS19

This product is not designed or intended for use outside the environmental limitations and operating parameters expressly stated on the product's data sheet. Products are not designed or intended for use in medical, military, aerospace, automotive or oil & gas applications or any safety-critical applications where a failure of the product could cause severe environmental or property damage, personal injury or death. Any use in such applications must be specifically agreed to by seller in writing, and is subject to such additional terms as the seller may impose in its sole discretion. Use of products in such applications is at buyer's own risk, and buyer will indemnify and hold harmless seller and its affiliates against any liability, loss, damage or expense arising from such use. Information contained in this data sheet was derived from product testing under controlled laboratory conditions and data reported thereon is subject to the stated tolerances and variations, or if none are stated, then to tolerances and variations consistent with usual trade practices and testing methods. The product's performance outside of laboratory conditions, including when one or more operating parameters is at its maximum range, may not conform to the product's data sheet. Further, information in the product's data sheet does not reflect the performance of the product in any application, end-use or operating environment buyer or its customer may put the product to. Seller and its affiliates make no recommendation, warranty or representation as to the suitability of the product for buyer's application, use, end-product, process or combination with any other product or as to any results buyer or its customer might obtain in their use of the product. Buyer should use its own knowledge, judgment, expertise and testing in selecting the product for buyer's application, end-use and/or operating environment, and should not rely on any oral or written statement, representation, or samples made by seller or its affiliates for any purpose. EXCEPT FOR THE WARRANTIES EXPRESSLY SET FORTH IN THE SELLER'S TERMS AND CONDITIONS OF SALE, SELLER MAKES NO WARRANTY EXPRESS OR IMPLIED WITH RESPECT TO THE PRODUCT, INCLUDING ANY WARRANTY OF MERCHANTABILITY OR FITNESS FOR ANY PARTICULAR PURPOSE, WHICH ARE DISCLAIMED AND EXCLUDED. All sales are subject to seller's exclusive terms and conditions of sale which, where the seller is (a) RLS Merilna tehnika d. o. o., are available at [www.rls.si/customer-service](http://www.rls.si/customer-service), (b) Renishaw, Inc., are available at [www.renishaw.com/Shop/legal/en/-42186](http://www.renishaw.com/Shop/legal/en/-42186), or (c) another person, are available on request, and in each case, are incorporated herein by reference, and are the exclusive terms of sale. No other terms and conditions apply. Buyer is not authorized to make any statements or representations that expand upon or extend the environmental limitations and operating parameters of the products, or which imply permitted usage outside of that expressly stated on the data sheet or agreed to in writing by seller.

RLS Merilna tehnika d. o. o. has made considerable effort to ensure the content of this document is correct at the date of publication but makes no warranties or representations regarding the content. RLS Merilna tehnika d. o. o. excludes liability, howsoever arising, for any inaccuracies in this document. © 2025 RLS d. o. o.