

LM13 linear magnetic encoder system

EMC compliance



The LM13 encoder system conforms to the relevant harmonised European standards for electromagnetic compatibility as detailed below.

BS EN 61326

Patents

Features of RLS's encoder systems and similar products are the subjects of the following patents and patent applications:

GB 0720972.9	EP 0514081
EP 0388453	US 5,241,173
US 5,063,685	JP 3,202,316
JP 2837483	

Further information

For further information relating to the installation of LM13 encoder system, see also the LM13 data sheet or LM13 DPI data sheet (part no. LM13D02 or LM13D04). These can be downloaded from our website www.rls.si and are also available from your local representative.

Disclaimer

Considerable effort has been made to ensure that the contents of this document are free from inaccuracies and omissions. However, RLS merilna tehnika d.o.o. makes no warranties with respect to the contents of this document and specifically disclaims any implied warranties. RLS merilna tehnika d.o.o. reserves the right to make changes to this document and to the product described herein without obligation to notify any person of such changes.

Storage and handling

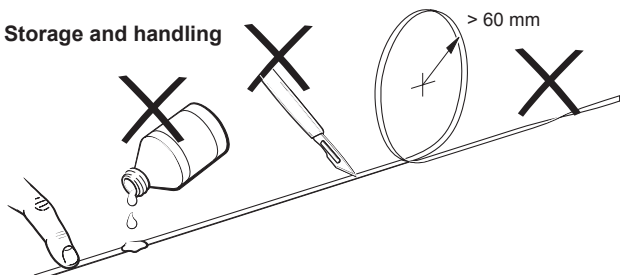

WARNING: The MS magnetic scale should not be exposed to magnetic field densities higher than 50 mT on its surface. Magnetic fields higher than 50 mT can damage the scale.

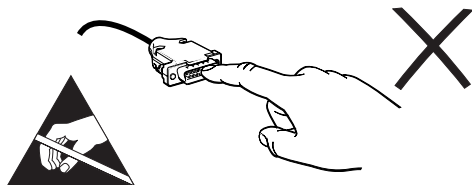
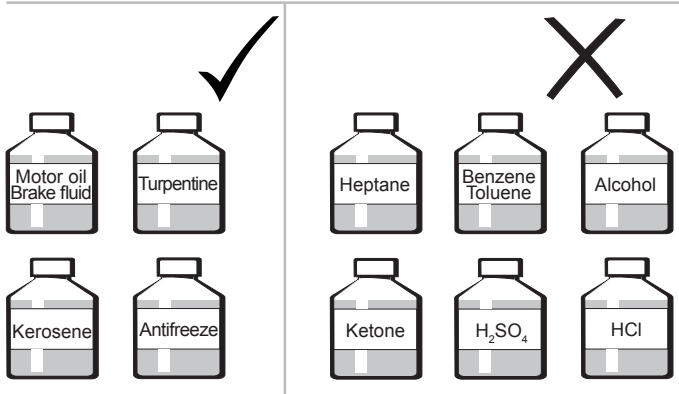

Storage and handling continued

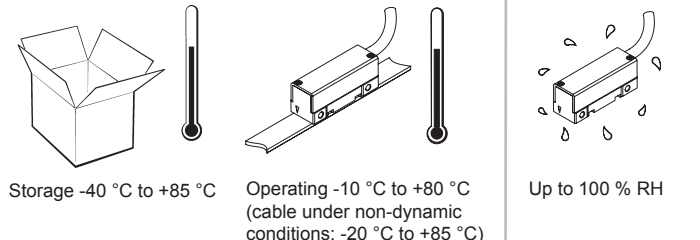
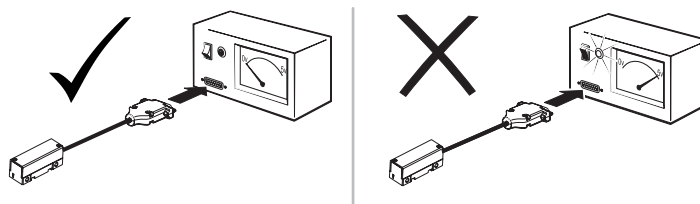

System description

The LM13 encoder system consists of an LM13 readhead on MS magnetic scale offering a range of industry standard digital and analogue output options.

Reference mark

The repeatable bi-directional reference signal can be provided in 4 ways.

- Stick-on reference mark.** The LM13 readhead should be ordered with the reference mark option. After installation of the scale a reference mark sticker can be applied to the scale at the required position using the reference mark applicator tool. Ensure that the reference sticker is oriented to the corresponding side of the readhead that has the reference mark detector installed.
- Selected at point of order.** The LM13 readhead should be ordered with the reference mark option. If required, the cover foil can be installed over the cut reference mark.
- Every 2 mm.** The LM13 readhead should be ordered with this specific mode activated only.
- Distance coded reference mark.** The distance coded reference mark option provides multiple reference marks that are individually spaced according to specific mathematical algorithm. For further information please refer to Distance coded reference mark data sheet (LM10D17).

LED indicator

The LM13 set-up LED provides visual feedback of signal strength, error condition, for set-up and diagnostic use.

Green indicates good signal strength/set-up

Red indicates poor signal strength - adjustment required

LM13 system dimensions

Dimensions and tolerances in mm.

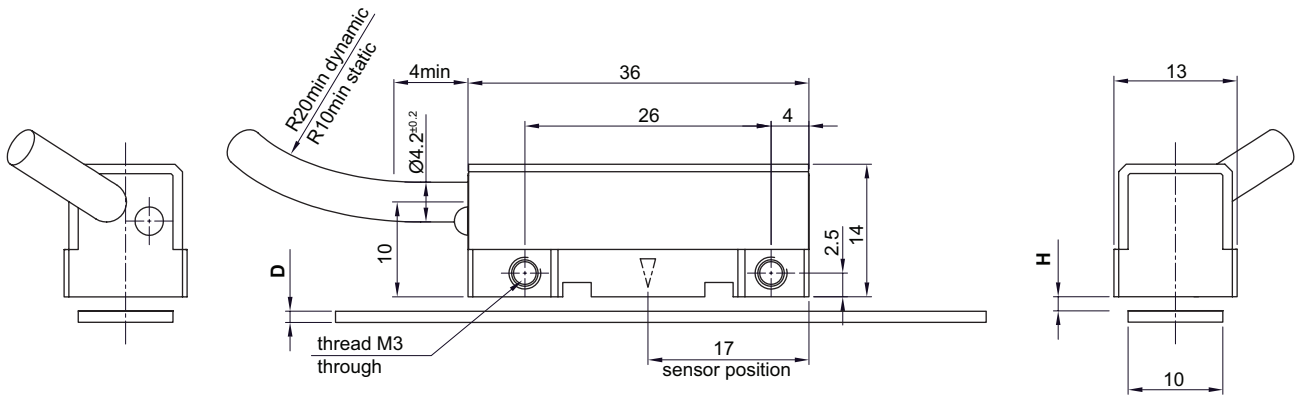

NOTE: Ensure recommended M3 readhead fixing screws are tightened to 0.5 Nm to 0.7 Nm.

Readhead installation tolerances

Ride height

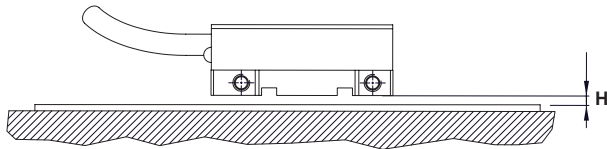

Pitch

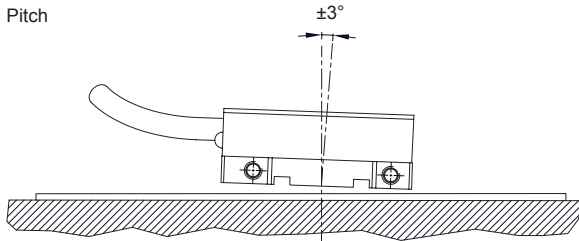

Yaw

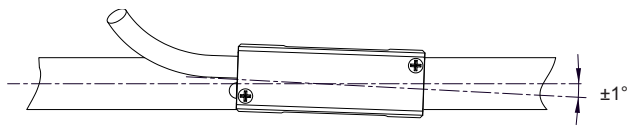

Roll

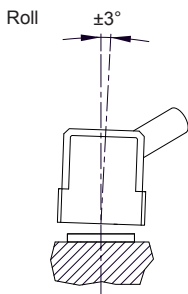

Lateral offset

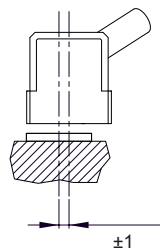

	Magnetic scale thickness (D)	Ride height (H)	
		Maximum range	Recommended range
No cover foil, cut or magnetised reference mark	1.5 ^{±0.2}	0.1 - 1.5	0.1 - 1.0
No cover foil, stick-on reference mark	1.5 ^{±0.2}	0.5 - 1.5	0.5 - 1.0
With cover foil, cut or magnetised reference mark	1.65 ^{±0.2}	0.1 - 1.3	0.1 - 0.9
With cover foil, stick-on reference mark	1.65 ^{±0.2}	0.5 - 1.3	0.5 - 0.9

* For larger ride height (H) please see LM15 linear encoder system (LM15D01).

General specifications

Power supply	4.7 V to 7 V – reverse polarity protected; voltage on readhead (see note below)
Power supply rise time (for PRG option only)	< 1 ms
Power consumption	< 35 mA for digital output type < 50 mA for analogue output type
Voltage drop over cable	~ 13 mV/m – without load ~ 54 mV/m – with 120 Ω load
Environmental sealing	IP68 (according to IEC 60529)
Temperature	Operating -10 °C to +80 °C (cable under non-dynamic conditions: -20 °C to +85 °C) Storage -40 °C to +85 °C
Shock	300 m/s ² , 11 ms (IEC 60068-2-27)
Vibration	300 m/s ² , 55 Hz to 2000 Hz (IEC 60068-2-6)
Mass	Readhead (1 m cable, no connector) 80 g, Cable (1 m) 34 g, Magnetic scale (1 m) 60 g, Cover foil (1 m) 3.5 g
Cable	Ø4.2 ^{±0.2} mm, PUR high flexible cable, drag-chain compatible, double-shielded 8 × 0.05 mm ² ; durability: 20 million cycles at 20 mm bend radius

Electrical connections

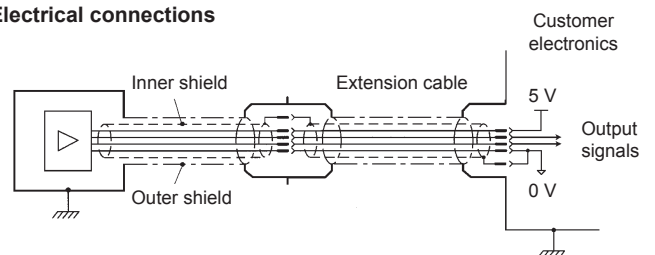

Readhead installation

Please refer to the MS magnetic scale installation guide (LM13D10) for installation of magnetic scale. Once the scale is installed the readhead can be easily adjusted on the machine using the set-up LED indicator.

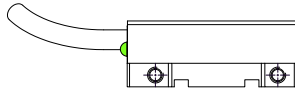

Green LED = good signal strength / set-up

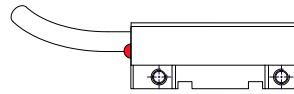

Red LED = poor signal strength - adjustment required
A, B, A-, B- outputs become high impedance

Programming (for IC output type only)

Readheads can be ordered preset to the required resolution or provided so that they can be programmed as needed on the machine to the chosen resolution. This programming is carried out by connecting the readhead to a computer via a programming interface. The readhead must be ordered with the PRG option to use this function.

LM13IC – Connections for digital outputs (RS422)

Function	Signal	Colour	15 pin D type plug (option D)	9 pin D type plug (option A)	15 pin HD type plug (option H)
Power	5 V	Brown	7	5	7
	0 V	White	2	9	2
Incremental signals	A+	Green	14	4	14
	A-	Yellow	6	8	6
	B+	Blue	13	3	13
	B-	Red	5	7	5
Reference mark	Z+	Pink	12	2	12
	Z-	Grey	4	6	4
Shield	Inner	-	15	1	15
	Outer	-	Case	Case	Case

Timing diagram

Complementary signals not shown

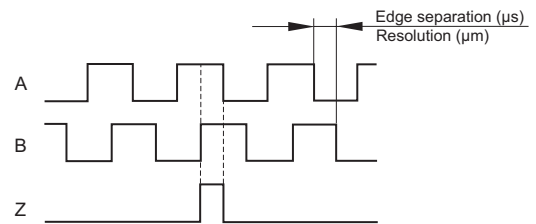

Recommended signal termination

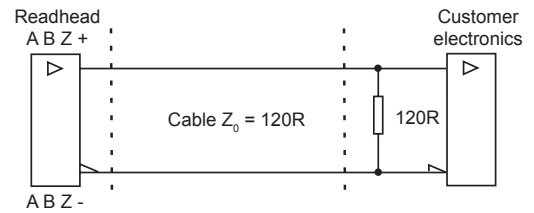

LM13AV – Connections for analogue outputs (1 V_{pp})

Function	Signal	Colour	15 pin D type plug (option L)	9 pin D type plug (option A)	9 pin D type plug (option P)
Power	5 V	Brown	4	5	5
	0 V	White	12	9	1
Analogue signals	V ₁	Green	9	4	2
	V ₁ -	Yellow	1	8	6
	V ₂	Blue	10	3	4
	V ₂ -	Red	2	7	8
Reference mark	V ₀	Pink	3	2	3
	V ₀ -	Grey	11	6	7
Shield	Inner	-	15	1	9
	Outer	-	Case	Case	Case

Timing diagram

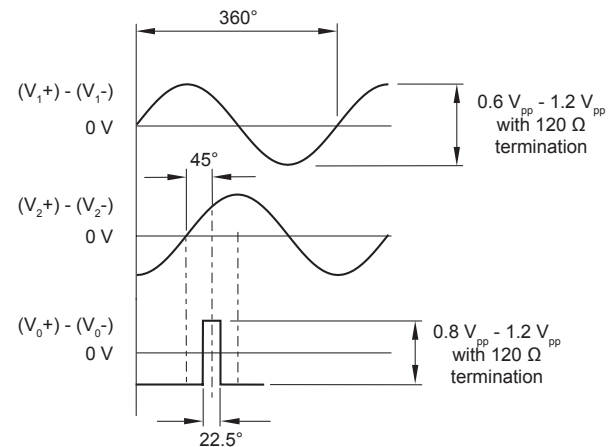

Recommended signal termination

