

Orbis™

Battery Backup Multiturn (BBM)

True Absolute Rotary Encoder

BATTERY
BACKUP
MULTITURN

EASY
INSTALLATION

HIGH SPEED

Orbis™ Battery Backup Multiturn is an absolute, through-hole rotary encoder with battery-powered multiturn counter that allows the encoder to count shaft rotations even when the main power supply is unavailable.

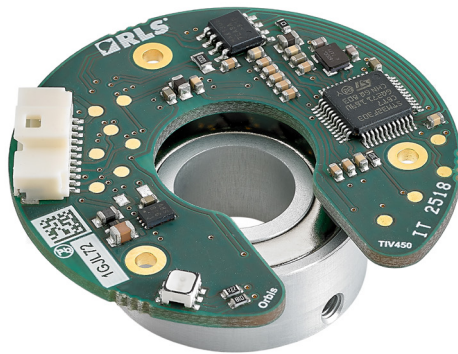

The encoder is a battery backup multiturn solution and part of the Orbis absolute encoder range. For technical specifications not included in this document, refer to the latest version of BRD01 data sheet, available for download from the [Orbis website](#).

Features and benefits

- ▶ True absolute
- ▶ 14 bit resolution
- ▶ Battery powered multiturn
- ▶ Through-hole design
- ▶ Built-in self-diagnostics
- ▶ Self-calibration after installation
- ▶ Integrated status LED
- ▶ BiSS C communication interface
- ▶ Easy installation
- ▶ Reduced accuracy thermal drift



GIMBALS



AGVs



MOTOR FEEDBACK
AND COMMUTATION



ROBOTIC JOINTS



AGRICULTURAL
AUTOMATION

General information

The encoder consists of a diametrically magnetized permanent ring magnet and a printed circuit board. The geometrical arrangement of RLS' proprietary Hall sensors on the PCB enables the generation of one period of sine and cosine signals per mechanical magnetic revolution. In addition, it also allows cancelation of the third harmonic component.

An adaptive filtering function provides high resolution at low rotation speeds and low angular phase delay at high rotation speeds. Orbis also has an additional built-in self-calibration algorithm that improves the accuracy of the encoder after installation.

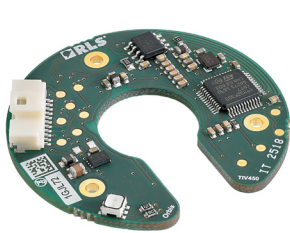

Orbis readhead

+

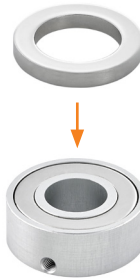

=



Orbis system

**Two options available:
permanent magnet or
magnetic actuator with
the magnet**

Storage and handling

Storage temperature



-40 °C to +105 °C

Operating temperature



-40 °C to +105 °C

Humidity



Up to 70 % non-condensing

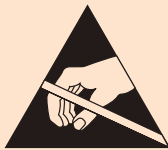

Readhead is ESD sensitive - handle with care.

Do not touch electronic circuit, wires or sensor area without proper ESD protection or outside of ESD controlled environment.

Chemical resistance

RLS products are often used in industrial applications and exposed to chemicals that can affect their internal and external components. While our products are designed to be resistant to many harsh chemicals and environments, long-term resistance will depend on exposure, temperature, and concentration. Most chemicals our products are exposed to are not in continuous contact. Therefore, a material that might not be resistant when submerged in a chemical will last indefinitely when wiped down by that same chemical once a day.

For further information or to confirm compatibility with a chemical in your environment, [contact RLS](#).

Packaging

Less than 20 products are packed individually in an antistatic box. If the order quantity is 20 systems and larger, the parts are packed in antistatic plastic trays. Magnets and readheads are packed separately.

Dimensions and installation drawings

Dimensions and tolerances are in mm.

BR10 Readhead

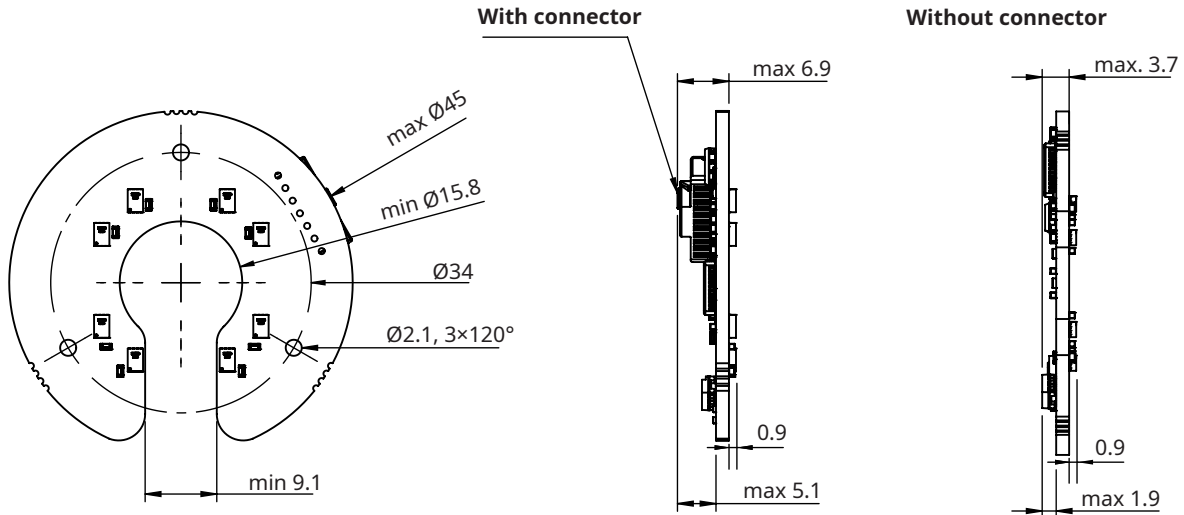

BM magnets and BA magnetic actuators

Permanent magnet

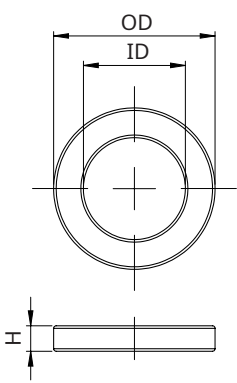

Available magnets:

ID	OD	H
12	19	3

ID and OD tolerances are ± 0.05 .

Magnetic actuator (magnet included)

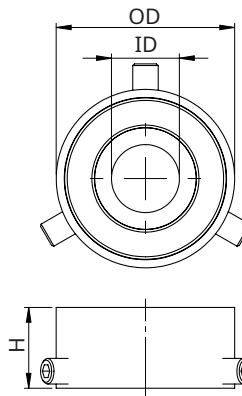

Available actuators:

ID	OD	H
6	21	9.5
8	21	9.5
10	22	9.5

ID tolerances are H7.

Installation drawing

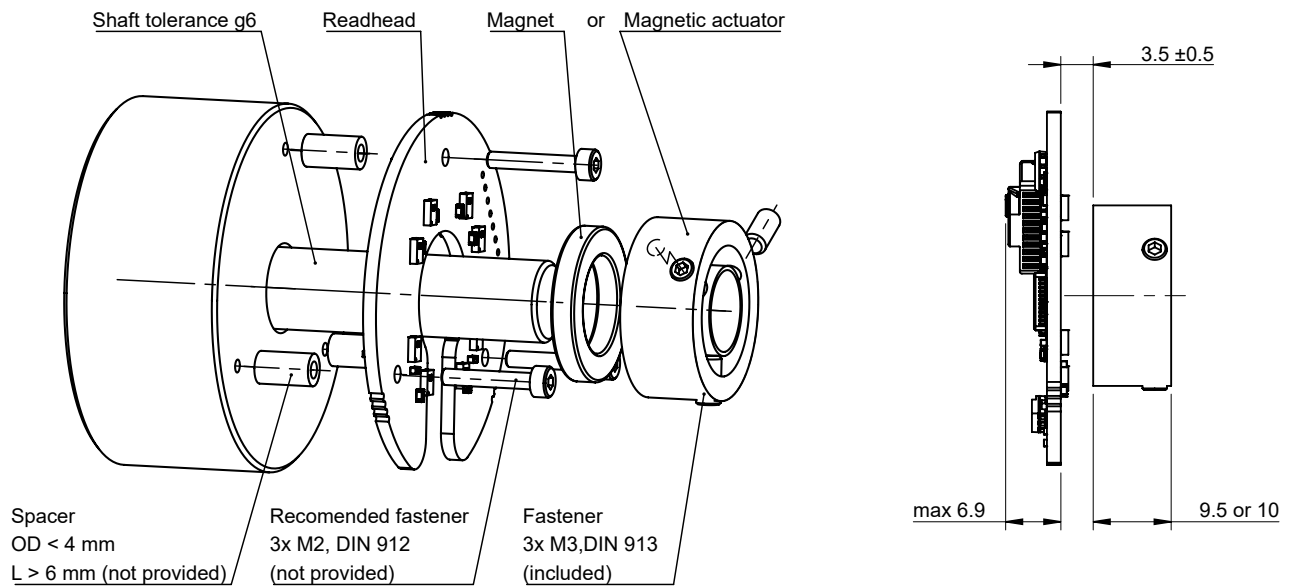

Readhead should only be mounted on the gold plated surfaces around the mounting holes. Mounting surfaces should be parallel within 0.02 mm. **See Installation instructions.**

For recommended tightening torques, refer to the document TTD01 available at **RLS Media center.**

Installation instructions

1. Install Orbis encoder readhead and magnetic actuator according to mechanical tolerances specification in document BRD01 at **RLS Media center**.
2. Connect main power supply and battery power supply. At this point, red LED should be blinking. The rotation speed should not be high during power-up of the encoder and when setting the multiturn counter.
3. Apply the multiturn counter twice in order to set the correct value (see section "Using Orbis BBM with Encosight Software" or Orbis BiSS C register access Application note, section Multiturn counter which can be downloaded from www.rls.si/orbis). Please wait at least 0.5 s between the first and the second multiturn counter value input. Green LED should be blinking.

Battery replacement

Follow the installation procedure and:

- Have the second battery connected to the encoder before disconnecting the first.
- Remember the multiturn counter value and set the multiturn based on this information after new battery is connected. Please follow the third paragraph of Installation procedure described above. Battery Error / Warning is cleared when the multiturn counter is set.

Technical specifications

System data

Resolution	14 bit
Accuracy	±0.25° (optimal installation)
Accuracy thermal drift	±0.003° /°C
Digital hysteresis	±2 LSB (counts)

Electrical data

Supply voltage	4.5 V to 5.5 V (at the connector)
Current consumption	Typ. 70 mA (no output load)
Battery supply voltage (V_{BAT})	3.15 V to 4.1 V (at the connector)*
Battery monitoring error threshold voltage	3.05 V
Battery monitoring warning threshold voltage	3.15 V
Supply current from battery (with main supply disconnected)	30 µA typ. (Speed <8000 RPM) at $V_{BAT} = 3.5 V$
Supply current from battery (with main supply connected)	4 µA

*Do not use Orbis BBM without an external battery connected. If only the battery power supply is connected, communication with encoder is not possible and LED will be turned off. To establish communication, the encoder must be connected to the main power supply.

Mechanical data

Mass	Readhead	5.3 g
	Magnetic actuator (ID)	6 mm: 6.0 g; 8 mm: 5.5 g; 10 mm: 5.7 g;
	Magnet (ID)	12 mm: 3.8 g

Environmental data

Operating and storage temperature	-40 °C to +105 °C
Humidity	0 % to 70 % non-condensing

Electrical connections

Pin	BiSS C
1	5 V supply
2	V_{BAT}
3	0 V (GND)
4	
5	-
6	-
7	MA+
8	MA-
9	Cable shield
10	SLO+
11	SLO-

Pinout

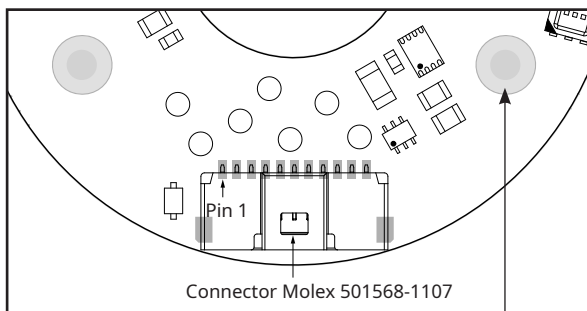

With connector

Cable shield
(connected to pin 9)

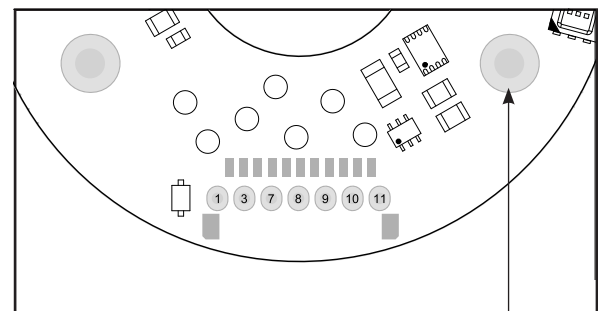

With soldering pads (through holes)
Pitch is 1.9 mm

Cable shield
(connected to pin 9)



Readhead is ESD sensitive - handle with care.

Do not touch electronic circuit, wires or sensor area without proper ESD protection or outside of ESD controlled environment.

Using Orbis BBM with BiSS C interface

1. Connect the battery.
2. Connect main power supply.
3. Connect BiSS communication lines to the controller (BiSS Master) that supports bidirectional communication (register access).
4. Verify that mechanical installation is correct and only Multiturn error bit is set. No other Error should be active.
Follow document BRD05 at [RLS Media center](#), pages 2 and 4.
5. Apply new multiturn counter value. Follow document BRD05 at [RLS Media center](#), page 6.
6. Repeat step 5. It must be written twice.
7. Verify there are no warning or error statuses present.
8. Use encoder as normal.
9. If disconnecting wires, make sure the battery remains connected to Orbis BBM encoder at all times.
If the battery is disconnected, the multiturn error will reappear.

Using Orbis BBM with Encosight Software

Procedure

1. Connect E201-9B BiSS C interface to the host computer with USB cable.
2. Connect Orbis BBM encoder to E201-9B BiSS C interface with a DB-9 connector cable.
3. Open Encosight program. You should be welcomed by the following screen:

Prerequisites:

- Latest version of Encosight Software (available for download at [E201-9B website](#))
- [E201-9B USB Encoder Interface](#)

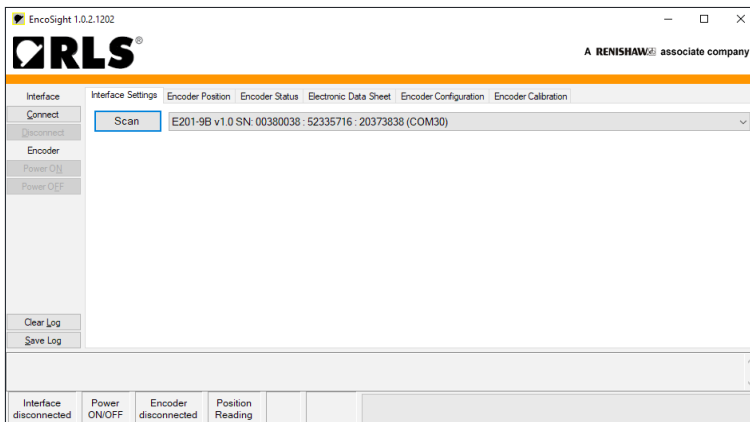

4. Software should automatically find E201-9B hardware and display it in the drop-down list. Click "Connect". The encoder should now be connected and its serial number should appear on the bottom label. If you go to the "Encoder Status" tab, you will find errors and warnings as shown below.

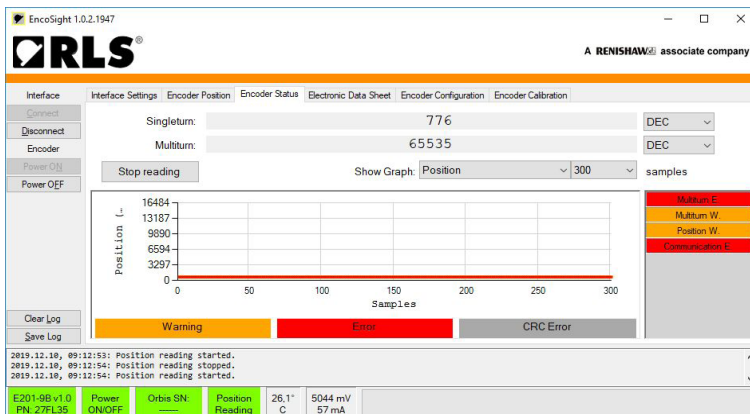

- Go to the “Encoder Configuration” tab. Write the desired value between 0 to 65535 for the multiturn counter and then press the “Set multiturn counter” button **twice**. If this was successful, the encoder error should now be cleared and green LED indicates that it is now ready for normal operation.
- You can display the singleturn and multiturn position of the encoder in the “Encoder Status” tab. You can also test the behaviour of the encoder without main supply by pressing the “Power OFF” button. This switches off the main power supply. In that case the LED light is turned off but the encoder still counts the rotations and updates the multiturn counter value. Singleturn position and reading values from the encoder is available only when the main power supply is turned on.

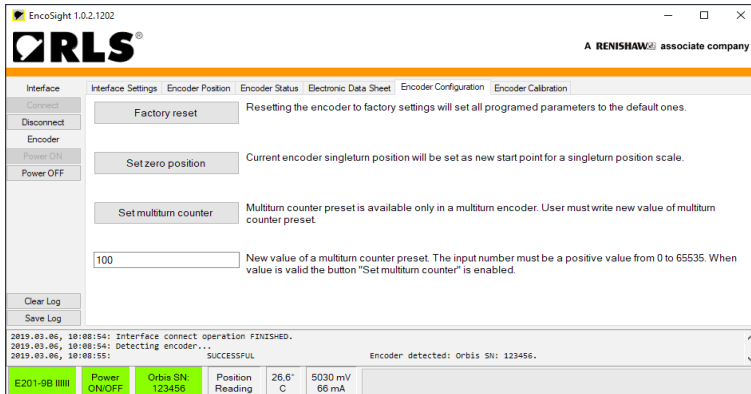

- When disconnecting E201-9B interface, make sure the battery remains connected to Orbis BBM encoder at all times. If the battery is disconnected, the multiturn error will reappear.

Multiturn status bit definitions

Multiturn status is accessible on BiSS Direct access registers on address 0x53 as one status byte. Definition of each bit can be found in table below:

Name	Bit	Description	Details	Solution
COMM_ERR	0	Communication error	Error in the internal encoder communication. This could be caused by physical damage to the communication lines or an irregular initialization process. Red LED. Position is invalid.	Check for any EMI around the read-head, reset Orbis encoder and cycle main power.
POS_ERR	1	General position error	General positioning errors can be the result of the following situations: <ul style="list-style-type: none"> • Insufficient presence of a magnetic field • Unexplained position change • Unexplained configuration change • Error in the initialization procedure • Temporarily insufficient power supply was detected Red LED. Position is invalid.	Check that Orbis is installed within the mechanical installation tolerances and that the readhead is not mechanically damaged. Cycle main power to the encoder and apply the multiturn counter value. *
BAT_ERR	2	Battery supply error **	The battery voltage is below the minimum level. This bit is latching; once set, it can only be cleared by applying a new multiturn counter value. The color of the LED depends on the situation in which the battery voltage level is detected: red if insufficient battery voltage was detected at encoder power-up, or yellow if insufficient battery voltage is detected during the regular encoder status check.	Change the battery and write a new multiturn counter value.
BAT_WNG	3	Battery supply warning **	The battery voltage is near the minimum level. Orange LED. Position is valid.	Procedure for battery replacement: <ol style="list-style-type: none"> 1. Leave Orbis powered on 2. Store current multiturn counter value 3. Remove battery 4. Insert new battery 5. Apply stored multiturn counter value to Orbis * Alternative: <ol style="list-style-type: none"> 1. Connect the new battery in parallel to the old battery 2. Remove the old battery quickly
Reserved	4	-	-	-
POS_WNG	5	General error at regular status checking	The multiturn value is checked at regular intervals. An error was detected during this check. See POS_ERR. Position is still valid, but not on the next power on. Orange LED. Position is valid.	Check that Orbis is within the mechanical installation tolerances and that the readhead is not mechanically damaged. Apply the multiturn counter value. *
COMM_WNG	6	Communication warning	Communication error occurred during the regular status check.	Check for any EMI around the read-head, reset Orbis encoder and cycle main power.
SYS_ERR	7	System error	Incorrect sensor version.	Contact RLS sales .

* Enter the multiturn counter value between 0 to 65535 twice in order to set the correct value. Please wait at least 0.5 s between the first and the second multiturn counter value input.

** Disconnected battery or low battery voltage is monitored every 10 seconds.

Battery selection guide

The battery capacity should be selected according to the expected total encoder off-time and supply current from the battery (see table on [page 6](#)). The battery consumption is independent of the rotation speed.

Duration time (approximate)	Battery capacity	Battery size
2 years	0.55 Ah	Coin
3.8 years	1.0 Ah	1/10 D
4.5 years	1.2 Ah	1/2 AA
9 years	2.5 Ah	AA
13 years	3.5 Ah	A

Duration times of the batteries are based on preliminary calculations.

Battery error status definitions

	Operating voltage /Condition	MT status (BiSS direct access register: 0x53)	Detailed status (BiSS direct access registers: 0x4A-0x4B)	Error/Warning	LED	Measures
1	BAT: 3.15 V–4.1 V, normal operation	0	0	No error/warning	Green	-
2	BAT: 3.05 V–3.15 V, normal operation	0x08 (BAT_WNG)	0x108 (MT warning)	Warning	Orange	Check battery
3	BAT: <3.05 V, normal operation	0x0C (BAT_WNG + BAT_ERR)	0x108 (MT warning)	Warning	Orange	Check battery
4	BAT: 3.05 V–3.15 V, after power cycle	0x0e (BAT_WNG)	0x108 (MT warning)	Warning	Orange	Check battery
5	BAT: <3.05 V, after power cycle	0x0e (BAT_ERR + BAT_WNG + POS_ERR)	0x308 (MT error)	Error	Red	Check battery Error clearance : setting MT counter

Communication interface:

Only BiSS C communication is supported.

Part numbering

Readhead

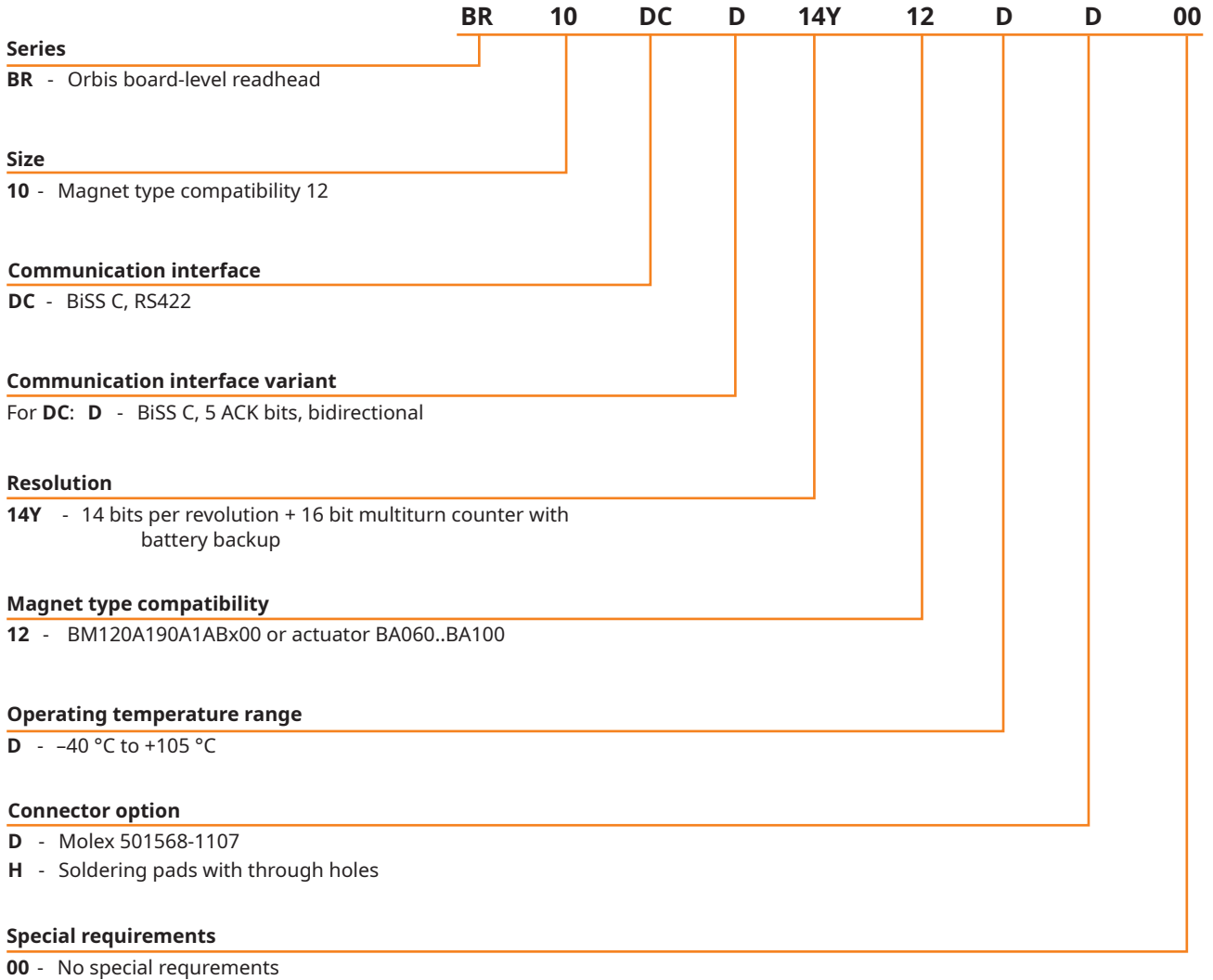

Not all part number combinations are valid. Refer to the table of available combinations below.

Table of available combinations

Series	Readhead size	Communication interface	Communication interface variant	Resolution	Magnet type compatibility	Operating temperature range	Connector option	Special requirements
BR	10	DC	D	14Y	12	D	D / H	00

Magnet

	BM	120	A	190	A	1	A	B	A	00
Series	BM - Orbis magnet									
Inner diameter	120 - 12 mm									
Thickness	A - 3 mm									
Outer diameter	190 - 19 mm									
Material	A - NdFeB									
Grade	1 - Grade 1 tested magnet									
Surface finishing	A - NiCuNi									
Temperature range	B - -40 °C to 120 °C									
Packaging	A - Standard packaging									
Special requirements	00 - No special requirements									

Not all part number combinations are valid. Refer to the table of available combinations below.

Table of available combinations

Series	Inner diameter	Thickness	Outer diameter	Material	Grade	Surface finishing	Temperature range	Packaging	Special requirements
BM	120	A	190	A	1	A	B	A	00

Magnetic actuator

	BA	060	AB	01	A	A	00
Series	BA - Orbis magnetic actuator						
Shaft diameter	060 - 6 mm 080 - 8 mm 100 - 10 mm						
Form	AB - With 3 fasteners						
Magnet type	01 - BM120A190A1ABA00						
Material	A - Anodized aluminium						
Packaging	A - Standard packaging						
Special requirements	00 - No special requirements						

Not all part number combinations are valid. Refer to the table of available combinations below.

Table of available combinations

Series	Shaft diameter	Form	Magnet type	Material	Packaging	Special requirements
BA	060	AB	01	A	A	00
	080					
	100					

Accessories



Cable assembly, 1 m

ACC035

ACC068

See chapter **Cable assemblies**.



Cable assembly, 1 m

ACC036

ACC069

See chapter **Cable assemblies**.



USB interface (for BiSS C communication interface)

E201-9B



Magnet viewer

MM0001

Cable assemblies

Cables with crimped connectors

Part number	Diameter	Length	Connector 1	Connector 2	Notes
ACC035	5 mm	1.0 m	Molex 501330-1100 and 501334-0000	Flying leads	Single-shielded
ACC036				DSUB-9 M	
ACC068	6.2 mm			Flying leads	
ACC069				DSUB-9 M	

Dimensions and tolerances are in mm.

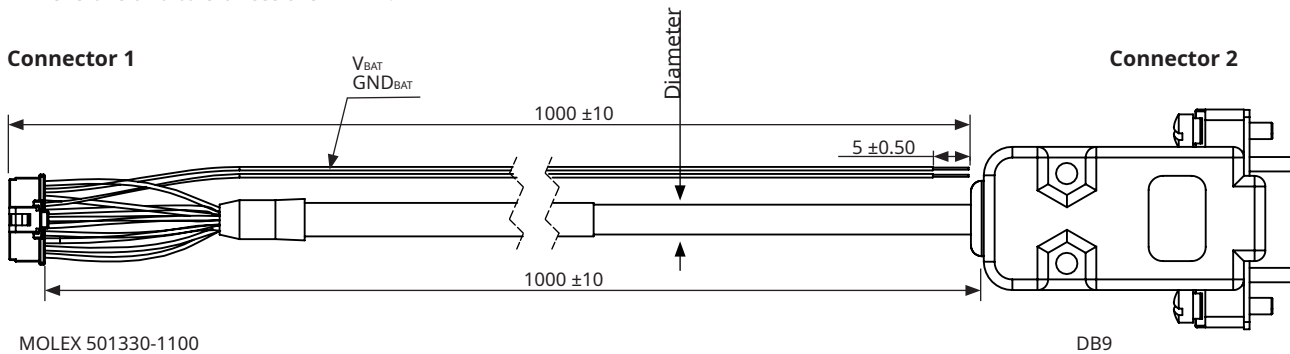

Connector 1 pin	Connector 2 pin	Wire color (flying lead)	BiSS C
1	5	Brown	5 V supply
2	External wire (violet)	Pink (flying lead) or Violet (external wire)	V _{BAT}
3	9	White	0 V (GND)
4	External wire (grey)	Grey	
5	-	-	-
6	-	-	-
7	2	Red	MA+
8	3	Blue	MA-
9	1	Cable shield	Cable shield
10	6	Green	SLO+
11	7	Yellow	SLO-

Cable specifications

Part numbers	ACC035, ACC036	ACC068, ACC069
Cable specifications	LI12YC12Y	LiYCY (TP)
Configuration	4 × 2 × 0.14 mm ²	4 × 2 × 0.14 mm ²
Rated voltage	250 V	350 V
Temperature range	Operating -30 °C to +100 °C Storage -40 °C to +105 °C Not valid for cables with DSUB-9 M connector.	Operating -40 °C to +75 °C (fixed) -5 °C to +70 °C (bending) Storage -40 °C to +80 °C
Environmental conformation	RoHS conform 73/23/EWG-Guideline CE conform Halogen free	RoHS and REACH compliant Flame-retardant according IEC 60332-1-2 Approvals based on VDE 0812 Classification ETIM 5.0 Class-ID: EC000104

ACC036 and ACC069 can be used for direct connection to **E201-9B** USB encoder interface.
ACC035 and ACC036 may be discontinued in future.

Head office

RLS Merilna tehnika d.o.o.

Poslovna cona Žeje pri Komendi
Pod vrbami 2
SI-1218 Komenda
Slovenia

T +386 1 5272100

E mail@rls.si

www.rls.si

Global support

Visit our [website](#) to contact your nearest sales representative.

Document issues

Issue	Date	Page	Description
1	12. 12. 2019	-	New document
2	11. 6. 2020	1, 5	Battery supply voltage amended
		2	Installation procedure amended
		3	Procedure of using Orbis BBM with Encosight software amended
		4	Multiturn status bit definitions amended
		7	Readhead part numbering amended
3	1. 3. 2022	6	Cable assemblies amended
4	4. 7. 2022	4, 24, 25	Packaging information amended, redesign of data sheet
5	28. 10. 2022	16	Cable assemblies amended

This product is not designed or intended for use outside the environmental limitations and operating parameters expressly stated on the product's datasheet. Products are not designed or intended for use in medical, military, aerospace, automotive or oil & gas applications or any safety-critical applications where a failure of the product could cause severe environmental or property damage, personal injury or death. Any use in such applications must be specifically agreed to by seller in writing, and is subject to such additional terms as the seller may impose in its sole discretion. Use of products in such applications is at buyer's own risk, and buyer will indemnify and hold harmless seller and its affiliates against any liability, loss, damage or expense arising from such use. Information contained in this datasheet was derived from product testing under controlled laboratory conditions and data reported thereon is subject to the stated tolerances and variations, or if none are stated, then to tolerances and variations consistent with usual trade practices and testing methods. The product's performance outside of laboratory conditions, including when one or more operating parameters is at its maximum range, may not conform to the product's datasheet. Further, information in the product's datasheet does not reflect the performance of the product in any application, end-use or operating environment buyer or its customer may put the product to. Seller and its affiliates make no recommendation, warranty or representation as to the suitability of the product for buyer's application, use, end-product, process or combination with any other product or as to any results buyer or its customer might obtain in their use of the product. Buyer should use its own knowledge, judgment, expertise and testing in selecting the product for buyer's application, end-use and/or operating environment, and should not rely on any oral or written statement, representation, or samples made by seller or its affiliates for any purpose. EXCEPT FOR THE WARRANTIES EXPRESSLY SET FORTH IN THE SELLER'S TERMS AND CONDITIONS OF SALE, SELLER MAKES NO WARRANTY EXPRESS OR IMPLIED WITH RESPECT TO THE PRODUCT, INCLUDING ANY WARRANTY OF MERCHANTABILITY OR FITNESS FOR ANY PARTICULAR PURPOSE, WHICH ARE DISCLAIMED AND EXCLUDED. All sales are subject to seller's exclusive terms and conditions of sale which, where the seller is (a) RLS Merilna tehnika d.o.o., are available at <https://www.rls.si/eng/salesterms>, (b) Renishaw, Inc., are available at <https://www.renishaw.com/legal/en/-42186>, or (c) another person, are available on request, and in each case, are incorporated herein by reference, and are the exclusive terms of sale. No other terms and conditions apply. Buyer is not authorized to make any statements or representations that expand upon or extend the environmental limitations and operating parameters of the products, or which imply permitted usage outside of that expressly stated on the datasheet or agreed to in writing by seller.

RLS Merilna tehnika d.o.o. has made considerable effort to ensure the content of this document is correct at the date of publication but makes no warranties or representations regarding the content. RLS Merilna tehnika d.o.o. excludes liability, howsoever arising, for any inaccuracies in this document. © 2022 RLS d.o.o.